

SF4920MCP1



Categorie	45 cm
Product familie	Oven
Stroomvoorziening	Elektrisch
Warmtebron	Elektriciteit
Bereidingswijze	Combi-microgolf
Reinigingssysteem	Vapor Clean reiniging
EAN-code	8017709241636



Design

Design	Victoria	Deur	Met paneel
Kleur	Crème	Handvat	Victoria
Design	Bol	Kleur handvat	Inox look
Materiaal	Gelakt materiaal	Logo	Geassembleerd
Type glas	Clear1	Bedieningsknoppen	Victoria
Kleur serigrafie	Zwart	Kleur bedieningsknoppen	Inox look
Type zeefdruk	Symbolen		









Bediening

Display	LCD	Aantal bedieningsknoppen	2
Bediening	Bedieningsknoppen		





Programma's / Functies

Aantal kookfuncties	13
Automatische programma's	20
Individualiseerbare recepten	No





Traditionele bereidingsfuncties

-  Statisch
-  Statisch + ventilator
-  Circulatie (ventilator + circulaire)
-  Turbo: ventilator + circulaire +
statisch
-  ECO
-  Grote grill
-  Ventilator + grote grill
-  Geventileerde onderwarmte

Bereidingsfuncties met microgolven

-  Microgolven
-  Microgolf + boven- en onderwarmte
+ ventilator
-  Microgolf + circulaire + ventilator
-  Microgolf + grill
-  Verwarmen en regenereren

Overige functies

-  Ontdooien op tijd
-  Ontdooien op gewicht
-  Rijzen
-  Sabbath

Reinigingsfuncties

-  Vapor Clean reiniging

Opties



Tijdsinstelling

Timer

Kinderbeveiliging

Automatische in- en uitschakeling

Ja

Ja

Andere opties

Showroom demo optie

Snel voorverwarmen

Warmhoudfunctie, Eco light, Quick Start

Ja

Ja

Technische specificaties



Minimum temperatuur	30 °C	Opening deur	Standaard opening
Maximum temperatuur	250 °C	Deur	Temperatuur gecontroleerde deur
Aantal kookniveaus	3	Totaal aantal ruiten	3
Aantal lampen	2	Automatische uitschakeling microgolf bij openen deur	Ja
Type lamp	Halogeen	Soft Close scharnieren	Ja
Vermogen lamp	40 W	Koelsysteem	Mantelkoeling
Verlichting bij opening deur	Ja	Koelleiding	Enkel
Onderwarmte - vermogen	1000 W	Afmetingen bruikbare interne ovenruimte (hxbxd)	212x462x407 mm
Grill - vermogen	2000 W	Temperatuurcontrole	Elektronisch
Circulatie - vermogen	1400 W	Materiaal ovenruimte	Ever Clean emaille
Warmte onderbroken bij openen deur	Ja	Veiligheidsscherm microgolfdeur	Ja

Prestaties / energielabel



Netto volume	40 l	Effectief vermogen microgolf	1000 W
Aantal ovens	1		

Meegeleverde accessoires

Ovenrooster met stop	1	Glazen ovenplaat	1
Inzetrooster	1		

Elektrische aansluiting

Spanning	220-240 V	Frequentie	50 Hz
Stroom	14 A	Lengte voedingskabel	115 cm
Nominale aansluitwaarde	3100 W		

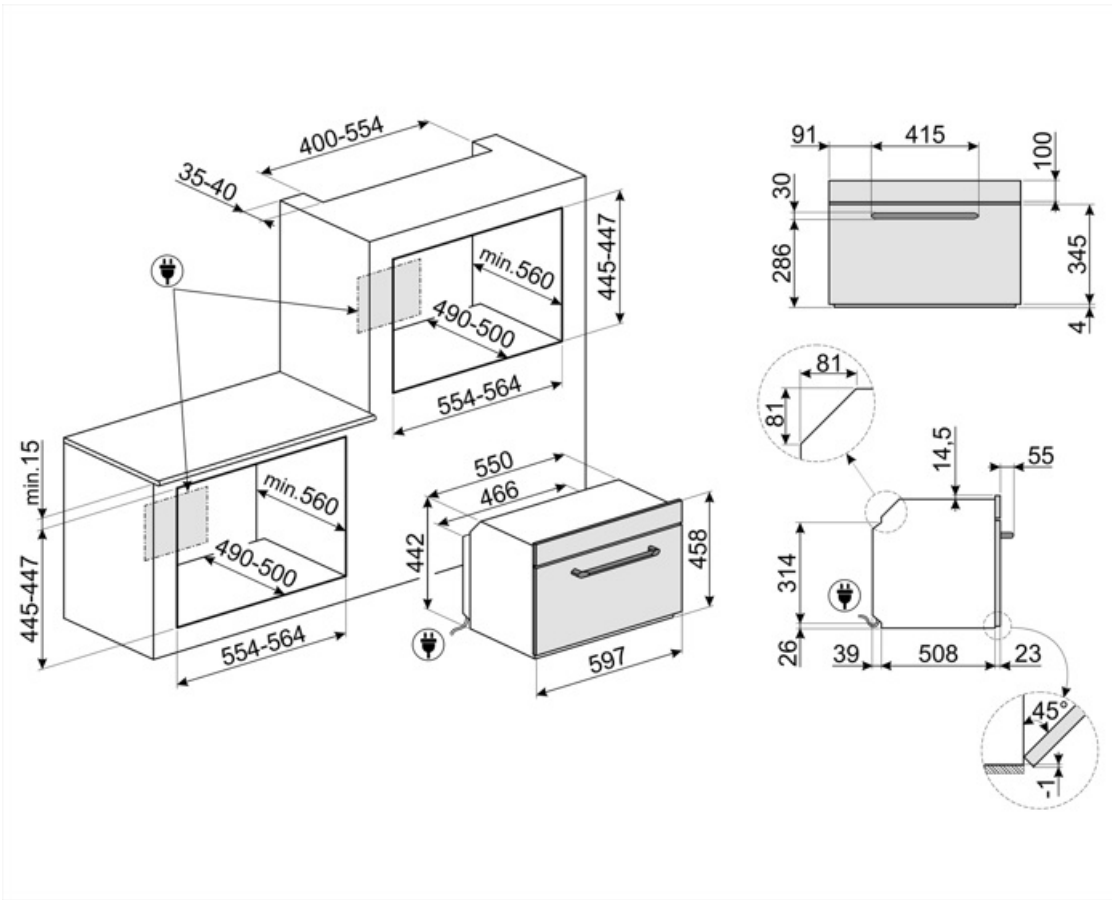

Compatible Accessories



BN620-1

Enamelled tray suitable for 45cm and 60cm ovens. Depth 20 mm. Perfect for a wide range of savoury and sweet baking.

GTP

Partially extractable telescopic guides (1 level), suitable for traditional ovens. Made in stainless steel, they guarantee stability and facilitate the smooth extraction of the trays.



PALPZ

Pizzapallet inox met ploibaar handvat, 315x325 mm



BN640

Enamelled tray suitable for 45cm and 60cm ovens. Depth 540 mm. Perfect for cooking and roasting meat and fish in sauces. Also ideal for experimenting with lighter and crunchy side dishes

GTT

Volledig uitschuifbare telescopische rails (1 niveau) voor traditionele ovens (SF-).





































PR3845X

Inox profiel voor installatie ovens in kolom



Symbols glossary

	Sommige modellen zijn voorzien van een functie om het programma/de cyclus te blokkeren zodat het niet per ongeluk kan aangepast worden.		Combination microwave: This oven allows to combine two different ways of cooking (Traditional with microwaves). Combined ovens increase cooking opportunities, while providing maximum flexibility of household appliances.
	Air cooling system: to ensure a safe surface temperatures.		Defrost by time: Manual defrost function. At the end of the set duration, the function stops.
	Defrost by weight: Automatic defrost function. You choose the type of food to defrost from the available categories (MEAT - FISH - BREAD - DESSERTS) After entering the weight of the food, the oven automatically defines the time required for proper defrosting.		Triple glazed doors: Number of glazed doors.
	Automatic lighting deactivation: For greater energy savings, the lighting turns off automatically after one minute from the start of cooking. The option can be disabled via the settings menu. In this case the light will remain on for the entire duration of cooking.		Elektrische aansluiting
	Ever Clean Enamel: Ever Clean enamel is applied electrostatically, corner to corner and edge to edge to prevent cracking or cracks over time. It is a particular pyrolytic enamel, resistant to acids which, in addition to being pleasantly bright, promotes greater cleaning of the oven walls, thanks to its lower porosity. It is baked at over 850 ° C and slowly polymerized at a scientifically determined rate to ensure uniform depth and strength. Ever Clean enamel creates an impeccable finish both on the inside of the oven and on the trays, making the surfaces of the oven incredibly easy to maintain over time as it reduces the adhesion of fat during cooking.		Circogas: In gasovens verdeelt de ventilator de warmte snel en gelijkmatig over de ovenruimte, waardoor smaakoverdracht wordt vermeden bij het tegelijkertijd bereiden van een aantal verschillende gerechten. In elektrische ovens voltooit deze combinatie het koken van voedsel dat aan de oppervlakte klaar is, maar dat van binnen meer moet worden gekookt, zonder verder bruin te worden.
	Ventilator met bovenste en onderste elementen: De elementen in combinatie met de ventilator zijn bedoeld om een meer gelijkmatige warmte te bieden, een methode die vergelijkbaar is met conventioneel koken, dus voorverwarmen is vereist. Het meest geschikt voor items die langzaam koken vereisen.		Alleen boven- en onder element: een traditionele kookmethode die het meest geschikt is voor losse items in het midden van de oven. De bovenkant van de oven zal altijd het heetst zijn. Ideaal voor gebraden vlees, fruitcake, brood etc.
	Circulaire: De combinatie van de ventilator en het ronde element eromheen zorgt voor een hete lucht kookmethode. Dit biedt vele voordelen, waaronder geen voorverwarmen als de kooktijd meer dan 20 minuten bedraagt, geen smaakoverdracht bij het gelijktijdig bereiden van verschillende soorten voedsel, minder energie en kortere kooktijden. Geschikt voor alle soorten voedsel.		De combinatie van de grill, de ventilator en onderwarmte is interessant voor het bereiden van kleine hoeveelheden.

- | | |
|---|--|
|  <p>Grill: Very intense heat coming only from above from a double heating element. The fan is not active. Provides excellent grilling and gratinating results. Used at the end of cooking, it gives a uniform browning to dishes.</p> |  <p>Fan grill: very intense heat coming only from above from a double heating element. The fan is active. It allows the optimal grilling of thickest meats. Ideal for large cuts of meat.</p> |
|  <p>Microwave: Penetrating straight into the food, microwaves cook very quickly and with considerable energy savings. Suitable for cooking without fat, they are also able to thaw and heat food without altering its original appearance and aroma. The microwave function can also be combined with conventional functions with all the resulting advantages. Ideal for all types of food.</p> |  <p>Cooking with the simultaneous use of the heating element in combination with fan and microwave supply.</p> |
|  <p>Microwave + grill element: The use of the grill results in a perfect browning of the surface of the food. The action of microwaves allows instead of cooking in a short time the internal part of the food.</p> |  <p>Fan combined with traditional cooking, where heat is generated from above and below, provides uniform heat. Adding the microwave function allows the same cooking results in less time.</p> |
|  <p>This function can reheat precooked dishes, without becoming dry or hard.</p> |  <p>Circulaire met bovenste en onderste elementen: door het gebruik van de ventilator met beide elementen kan voedsel snel en effectief worden gekookt, ideaal voor grote stukken vlees die grondig moeten worden gekookt. Het biedt een vergelijkbaar resultaat als rotisserie, waarbij de warmte rond het voedsel wordt verplaatst in plaats van het voedsel zelf te verplaatsen, waardoor elke maat of vorm kan worden gekookt.</p> |
|  <p>Compacte toestellen met een hoogte van 45 cm - perfecte oplossing om te voldoen aan de functionele eisen van keukensets met een kleine hoogte. Verkrijgbaar in verschillende soorten en in verschillende stijlen.</p> |  <p>Met deze functie kan u bereidingen warmhouden zodat het eten niet meteen afkoelt</p> |
|  <p>Side lights: Two opposing side lights increase visibility inside the oven.</p> |  <p>ECO-logic: option allows you to restrict the power limit of the appliance real energy saving.</p> |
|  <p>Air at 40°C provides the perfect environment for proving yeast type dough mixes. Simply select the function and place dough in the cavity for allotted</p> |  <p>Rapid preheating: cooking is preceded by the preheating phase which allows the cooking compartment to reach the set temperature. This option reduces the time by up to 50%.</p> |
|  <p>SABBATH: function that allows to cook food respecting Judaism's day of rest provisions.</p> |  <p>The oven cavity has 3 different cooking levels.</p> |
|  <p>Alle modellen zijn voorzien van een soft close deursysteem waarbij de deur zacht en stil sluit.</p> |  <p>Electronic control: Allows you to maintain temperature inside the oven with the precision 2-3 ° C. This enables to cook meals that are very sensitive to temperature changes, such as cakes, souffles, puddings.</p> |
|  <p>Tilting grill: the tilting grill can be easily unhooked to move the heating element and clean the roof of the appliance in one simple step.</p> |  <p>Vapor Clean: a simple cleaning function using steam to loosen deposits in the oven cavity.</p> |



The capacity indicates the amount of usable space in the oven cavity in litres.



The capacity indicates the amount of usable space in the oven cavity in litres.