

SF6200TSI



Category	60 cm
Product Family	Oven
Power supply	Electric
Heat source	ELECTRICITY
Cooking method	Thermo-ventilated
Cleaning system	Vapor Clean
EAN code	8017709361341



Aesthetics

Aesthetic	Musa	Serigraphy type	Symbols
Colour	Silver	Door	Full glass
Finishing	Glossy	Handle	Musa
Design	Flat	Handle Colour	Black
Material	Glass	Logo	Silk screen
Glass Type	Eclipse	Control knobs	Musa
Serigraphy colour	White	Controls colour	Black

Controls



Display name	DigiScreen	Control setting	Knobs & touch buttons
Display technology	LED	No. of controls	2

Programs / Functions main oven

No. of cooking functions 8
Traditional cooking functions

Static	Fan assisted	Circulaire
Turbo	Eco	Large grill
Fan grill (large)	Fan assisted base	

Other functions



Leavening



Stone cooking



Air-Fry

Cleaning functions



Vapor Clean

Options



Time-setting options	Delay start and automatic end cooking	Timer	1
Minute minder	Yes	Rapid pre-heating	Yes

Technical Features



Capacity (Lt)	70 l	Circular heating element - Power	2000 W
Cavity	Sares	Heating suspended when door is opened	Yes
Minimum Temperature	60 °C	Door opening type	Standard opening
Maximum temperature	250 °C	Door	Temperate door
No. of shelves	5	Removable door	Yes
N. of fans	1	Full glass inner door	Yes
No. of lights	1	Removable inner door	Yes
Light type	Halogen	Total no. of door glasses	3
User-replaceable light	Yes	Chimney	Fixed
Light Power	40 W	Cooling system	Tangential
Light when door is opened	Yes	Cooling duct	Single
Lower heating element power	1200 W	Speed Reduction Cooling System	Yes
Upper heating element - Power	1000 W	Usable cavity space dimensions (HxWxD)	360x460x425 mm
Grill element - power	1700 W	Temperature control	Electro-mechanical
Large grill - Power	2700 W	Cavity material	Ever clean Enamel

Performance / Energy Label



Energy efficiency class	A	Energy consumption in forced air convection	2.88 MJ
Net volume of the cavity	70 l	Energy consumption per cycle in fan-forced convection	0.80 kWh
Energy consumption per cycle in conventional mode	1.15 kWh	Number of cavities	1
Energy consumption in conventional mode	4.14 MJ	Energy efficiency index	95.2 %

Accessories included

Rack with back stop	1	Enamelled deep tray (40mm)	1
---------------------	---	----------------------------	---

Electrical Connection

Voltage	220-240 V	Nominal power	3000 W
Plug	Cable with free ends	Frequency (Hz)	50/60 Hz
Current	13 A	Power supply cable length	150 cm

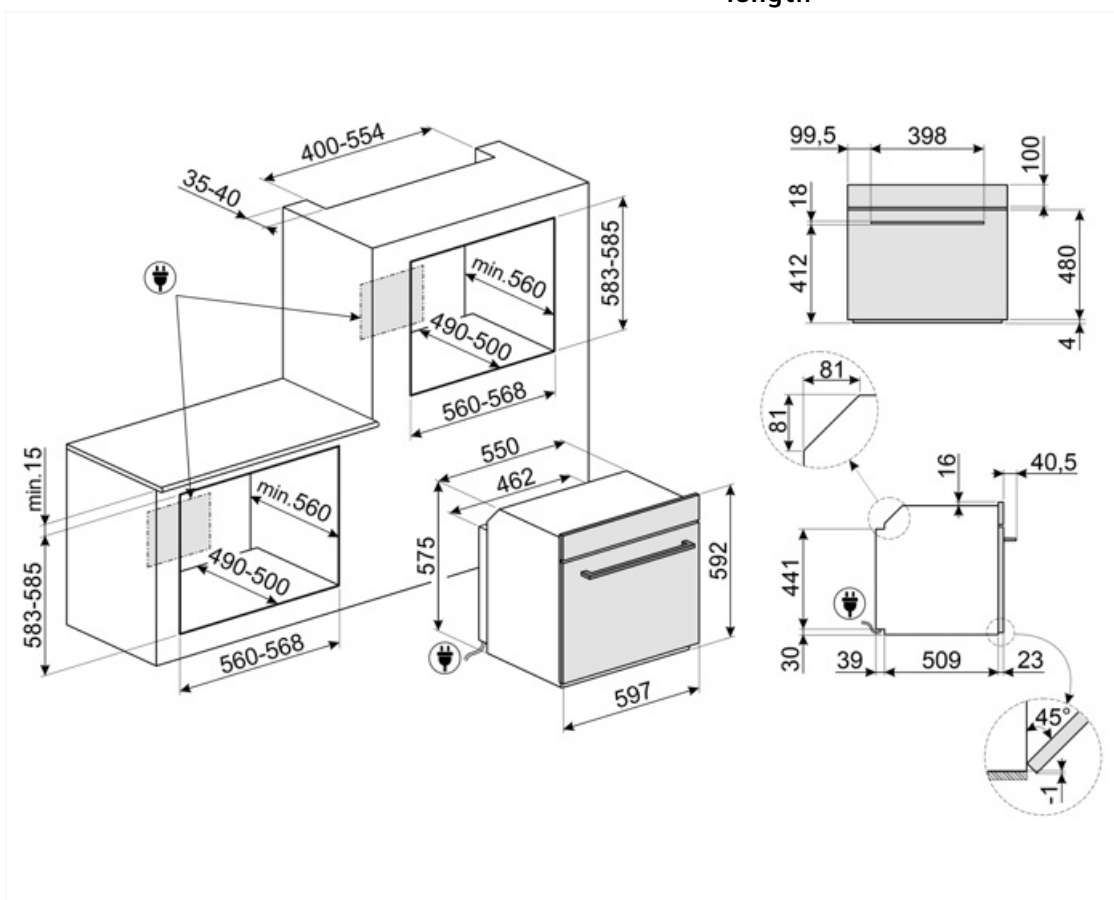

Compatible Accessories

AIRFRY2

Air fryer tray. Ideal for recreating traditional frying in the oven, but with fewer calories and less fat. It allows you to cook quickly and simply dishes such as French fries, fried vegetables and fish, ensuring perfect browning and crispiness.



BN620-1

Enamelled tray suitable for 45 cm and 60 cm ovens. Depth 20 mm. Perfect for a wide range of savoury and sweet baking.



GTP

Partially extractable telescopic guides (1 level), suitable for traditional ovens. Made in stainless steel, they guarantee stability and facilitate the smooth extraction of the trays.



PALPZ

Pizza shovel with folding handle. Dimensions L31.5 x H32.5 cm. Easy and convenient to use and store. Perfect for serving pizza, bread and savory pastries in a safe and professional way.



BBQ

Double sided plate BBQ. Suitable for recreating succulent and crispy dishes in the oven with the typical taste of grilled cooking. The ribbed side is particularly suitable for meats and cheeses. The smooth side for fish, seafood and vegetables.



BN640

Enamelled tray suitable for 45cm and 60cm ovens. Depth 540 mm. Perfect for cooking and roasting meat and fish in sauces. Also ideal for experimenting with lighter and crunchy side dishes



GTT

Totally extractable telescopic guides (1 level), suitable for traditional ovens. Made in stainless steel, they guarantee stability and facilitate the smooth extraction of the trays.



STONE2

Rectangular pizza stone without handles, suitable for 45cm and 60cm wide ovens. Dimensions W42 x H1.8 x D37.5cm. Ideal for cooking pizzas with the same results as a typical wood-fired oven. Can also be used for baking bread, focaccias and other recipes such as pies, flans or biscuits















Alternative products













SF6200TBI

Black

Symbols glossary

 Energy efficiency class A	 Air cooling system: to ensure a safe surface temperatures.
 4.3 inch display with LED technology, usability with knobs + 3 touch keys	 Triple glazed doors: Number of glazed doors.
 Electric	 Ever Clean Enamel: Ever Clean enamel is applied electrostatically, corner to corner and edge to edge to prevent cracking or cracks over time. It is a particular pyrolytic enamel, resistant to acids which, in addition to being pleasantly bright, promotes greater cleaning of the oven walls, thanks to its lower porosity. It is baked at over 850 °C and slowly polymerized at a scientifically determined rate to ensure uniform depth and strength. Ever Clean enamel creates an impeccable finish both on the inside of the oven and on the trays, making the surfaces of the oven incredibly easy to maintain over time as it reduces the adhesion of fat during cooking.
 Dedicated cooking function for the Air fryer rack AIRFRY . Ideal for recreating traditional frying in the oven, but with fewer calories and less fat. It allows you to cook quickly and simply dishes such as French fries, fried vegetables and fish, ensuring perfect browning and crispiness.	 Fan assisted base: the mix of fan and lower heating element alone allows to finish cooking foods already cooked on the surface but not internally more quickly. This system is recommended to finish cooking foods that are already well cooked on the surface, but not internally, which therefore require a moderate higher heat. Ideal for any type of food.
 Fan assisted: Intense and homogeneous traditional cooking, also suitable for complex recipes. The fan is active and the heat comes from below and from above at the same time. Ventilated cooking ensures a faster and more homogeneous result, leaving fragrant foods outside and moister inside. Ideal for baked pasta, biscuits, roasts and cobblers.	 Static: Traditional cooking suitable for the preparation of one dish at a time. The fan is not active and the heat comes from below and from above at the same time. Static cooking is slower and more delicate, ideal in order to get well cooked and dry dishes even inside. Ideal for cooking all types of roasts, fatty meats, bread, filled cakes.
 Circulaire: it is the perfect function for cooking all types of dishes in a more delicate way. The heat comes from the back of the oven and is distributed quickly and evenly. The fan is active. It is also ideal for cooking on multiple levels without mixing smells and flavors.	 ECO: low energy consumption cooking: this function is particularly suitable for cooking on a single shelf with low energy consumption. It is recommended for all types of food except those that can generate a lot of moisture (for example vegetables). To achieve maximum energy savings and reduce time, it is recommended to put the food in the oven without preheating the cooking compartment.
 Grill: Very intense heat coming only from above from a double heating element. The fan is not active. Provides excellent grilling and gratinating results. Used at the end of cooking, it gives a uniform browning to dishes.	 Fan grill: very intense heat coming only from above from a double heating element. The fan is active. It allows the optimal grilling of thickest meats. Ideal for large cuts of meat.

-
-  Turbo: the heat comes from 3 directions: above, below and from the back of the oven. The fan is active. It allows quick cooking, even on several shelves without mixing the aromas. Ideal for large volumes or foods that require intense cooking.
 -  The inner door glass: can be removed with a few quick movements for cleaning.
 -  Air at 40°C provides the perfect environment for proving yeast type dough mixes. Simply select the function and place dough in the cavity for allotted
 -  The oven cavity has 5 different cooking levels.
 -  The capacity indicates the amount of usable space in the oven cavity in litres.
 -  Dedicated cooking function for the rectangular refractory stone PPR2 Dimensions Ideal for cooking pizzas with the same results as a typical wood-fired oven. Can also be used for baking bread, focaccias and other recipes such as pies, flans or biscuits
 -  All glass inner door: All glass inner door, a single flat surface which is simple to keep clean.
 -  Side lights: Two opposing side lights increase visibility inside the oven.
 -  Rapid preheating: cooking is preceded by the preheating phase which allows the cooking compartment to reach the set temperature. This option reduces the time by up to 50%.
 -  Vapor Clean: a simple cleaning function using steam to loosen deposits in the oven cavity.
 -  The capacity indicates the amount of usable space in the oven cavity in litres.