

# SF6201TBI



Category	60 cm
Product Family	Oven
Power supply	Electric
Heat source	ELECTRICITY
Cooking method	Thermo-ventilated
Cleaning system	Vapor Clean
EAN code	8017709363666



## Aesthetics

Aesthetic	Musa	Door	Full glass
Colour	Black	Handle	Musa
Design	Flat	Handle Colour	Black
Material	Glass	Logo	Silk screen
Glass Type	Eclipse	Control knobs	Musa
Serigraphy colour	Grey	Controls colour	Black
Serigraphy type	Symbols		

## Controls











Display name	CompactScreen	Control setting	Knobs
Display technology	LCD	No. of controls	2



## Programs / Functions main oven

No. of cooking functions	10
--------------------------	----

## Traditional cooking functions

 Static	 Fan assisted	 Circulaire
 Turbo	 Eco	 Large grill
 Fan grill (large)	 Base	 Circulaire + bottom
 Pizza		

## Other functions

 Defrost by time	 Leavening	 Sabbath
--	---	---

## Cleaning functions

 Vapor Clean
--

## Options



<b>Time-setting options</b>	Delay start and automatic end cooking	<b>Other options</b>	Keep warm
<b>Minute minder</b>	Yes	<b>Showroom demo option</b>	Yes
<b>Timer</b>	1	<b>Rapid pre-heating</b>	Yes
<b>Controls Lock / Child Safety</b>	Yes		

## Technical Features



<b>Capacity (Lt)</b>	72 l	<b>Circular heating element - Power</b>	2000 W
<b>Cavity</b>	Sares	<b>Heating suspended when door is opened</b>	Yes
<b>Minimum Temperature</b>	30 °C	<b>Door opening type</b>	Standard opening
<b>Maximum temperature</b>	280 °C	<b>Door</b>	Temperate door
<b>No. of shelves</b>	5	<b>Removable door</b>	Yes
<b>N. of fans</b>	1	<b>Full glass inner door</b>	Yes
<b>No. of lights</b>	1	<b>Removable inner door</b>	Yes
<b>Light type</b>	Halogen	<b>Total no. of door glasses</b>	3
<b>User-replaceable light</b>	Yes	<b>Cooling system</b>	Tangential
<b>Light Power</b>	40 W	<b>Cooling duct</b>	Single
<b>Light when door is opened</b>	Yes	<b>Usable cavity space dimensions (HxWxD)</b>	360x460x425 mm
<b>Lower heating element power</b>	1200 W	<b>Temperature control</b>	Electronic
<b>Grill element - power</b>	1800 W	<b>Cavity material</b>	Ever clean Enamel

## Performance / Energy Label



**Energy efficiency class** A+  
**Net volume of the cavity** 70 l  
**Energy consumption per cycle in conventional mode** 1,13 kWh  
**Energy consumption in conventional mode** 4,07 MJ

**Energy consumption in forced air convection** 2,45 MJ  
**Energy consumption per cycle in fan-forced convection** 0,68 kWh  
**Number of cavities** 1  
**Energy efficiency index** 81 %

## Accessories included

**Rack with back stop** 1

**Enamelled deep tray (40mm)** 1

## Electrical Connection

**Voltage** 220-240 V  
**Plug** Cable with free ends  
**Current** 13 A

**Nominal power** 3000 W  
**Frequency (Hz)** 50/60 Hz  
**Power supply cable length** 150 cm

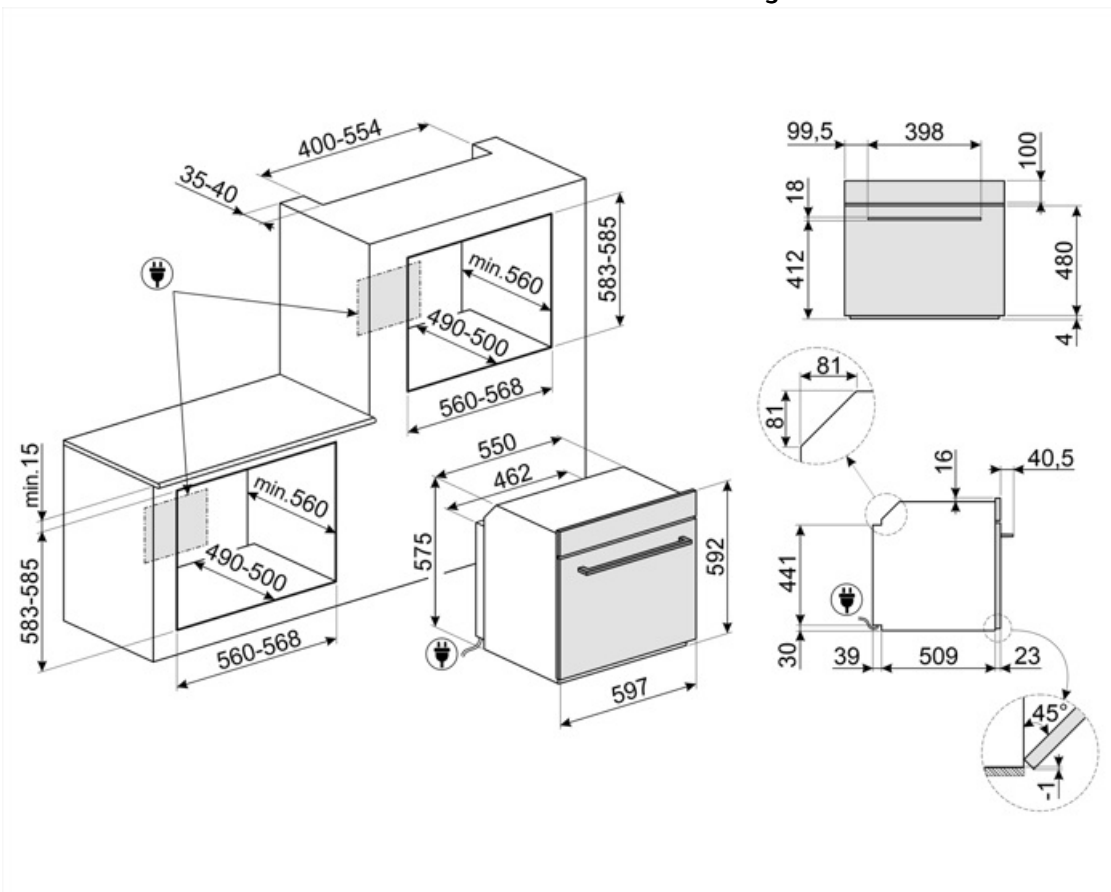

---

## Compatible Accessories

















---

### STONE2

Rectangular pizza stone without handles, suitable for 45cm and 60cm wide ovens. Dimensions W42 x H1.8 x D37.5cm. Ideal for cooking pizzas with the same results as a typical wood-fired oven. Can also be used for baking bread, focaccias and other recipes such as pies, flans or biscuits



## Symbols glossary

 <p><b>Child lock:</b> some models are fitted with a device to lock the programme/cycle so it cannot be accidentally changed.</p>	 <p><b>A+:</b> Energy efficiency class A+ helps to save up to 10% energy compared to class A. Maximum performance with minimum consumption is guaranteed.</p>
 <p><b>Air cooling system:</b> to ensure a safe surface temperatures.</p>	 <p><b>Defrost by time:</b> Manual defrost function. At the end of the set duration, the function stops.</p>
 <p><b>Triple glazed doors:</b> Number of glazed doors.</p>	 <p><b>Electric</b></p>
 <p><b>Ever Clean Enamel:</b> Ever Clean enamel is applied electrostatically, corner to corner and edge to edge to prevent cracking or cracks over time. It is a particular pyrolytic enamel, resistant to acids which, in addition to being pleasantly bright, promotes greater cleaning of the oven walls, thanks to its lower porosity. It is baked at over 850 °C and slowly polymerized at a scientifically determined rate to ensure uniform depth and strength. Ever Clean enamel creates an impeccable finish both on the inside of the oven and on the trays, making the surfaces of the oven incredibly easy to maintain over time as it reduces the adhesion of fat during cooking.</p>	 <p><b>Fan assisted:</b> Intense and homogeneous traditional cooking, also suitable for complex recipes. The fan is active and the heat comes from below and from above at the same time. Ventilated cooking ensures a faster and more homogeneous result, leaving fragrant foods outside and moister inside. Ideal for baked pasta, biscuits, roasts and cobblers.</p>
 <p><b>Static:</b> Traditional cooking suitable for the preparation of one dish at a time. The fan is not active and the heat comes from below and from above at the same time. Static cooking is slower and more delicate, ideal in order to get well cooked and dry dishes even inside. Ideal for cooking all types of roasts, fatty meats, bread, filled cakes.</p>	 <p><b>Base:</b> the heat comes only from the bottom of the cavity. The fan is not active. Ideal for sweet and savory pies, cobblers and pizzas. Designed to complete cooking and make food more crunchy. This symbol in gas ovens indicates the gas burner.</p>
 <p><b>Circulaire with lower element:</b> The addition of the lower element adds extra heat at the base for food which requires extra cooking.</p>	 <p><b>Circulaire:</b> it is the perfect function for cooking all types of dishes in a more delicate way. The heat comes from the back of the oven and is distributed quickly and evenly. The fan is active. It is also ideal for cooking on multiple levels without mixing smells and flavors.</p>
 <p><b>ECO:</b> low energy consumption cooking: this function is particularly suitable for cooking on a single shelf with low energy consumption. It is recommended for all types of food except those that can generate a lot of moisture (for example vegetables). To achieve maximum energy savings and reduce time, it is recommended to put the food in the oven without preheating the cooking compartment.</p>	 <p><b>Grill:</b> Very intense heat coming only from above from a double heating element. The fan is not active. Provides excellent grilling and gratinating results. Used at the end of cooking, it gives a uniform browning to dishes.</p>
 <p><b>Fan grill:</b> very intense heat coming only from above from a double heating element. The fan is active. It allows the optimal grilling of thickest meats. Ideal for large cuts of meat.</p>	 <p><b>Pizza function:</b> Specific function for cooking pizza in a pan. It allows to obtain a pizza that is soft inside and crispy outside with the topping perfectly cooked, not dry and not burnt.</p>



**Turbo:** the heat comes from 3 directions: above, below and from the back of the oven. The fan is active. It allows quick cooking, even on several shelves without mixing the aromas. Ideal for large volumes or foods that require intense cooking.



**The inner door glass:** can be removed with a few quick movements for cleaning.



**Side lights:** Two opposing side lights increase visibility inside the oven.



**Rapid preheating:** cooking is preceded by the preheating phase which allows the cooking compartment to reach the set temperature. This option reduces the time by up to 50%.



**The oven cavity has 5 different cooking levels.**



**Vapor Clean:** a simple cleaning function using steam to loosen deposits in the oven cavity.



**The capacity indicates the amount of usable space in the oven cavity in litres.**



**All glass inner door:** All glass inner door, a single flat surface which is simple to keep clean.



**KEEP\_WARM\_72dpi**



**Air at 40°C** provides the perfect environment for proving yeast type dough mixes. Simply select the function and place dough in the cavity for allotted



**SABBATH:** function that allows to cook food respecting Judaism's day of rest provisions.



**Electronic control:** Allows you to maintain temperature inside the oven with the precision 2-3 ° C. This enables to cook meals that are very sensitive to temperature changes, such as cakes, souffles, puddings.



**The capacity indicates the amount of usable space in the oven cavity in litres.**



With a simple and intuitive interface, the **COMPACTscreen** provides a pleasant user experience, thanks to the interaction with the knobs.