

SF6400TVN



Categorie	60 cm
Product familie	Oven
Stroomvoorziening	Elektrisch
Warmtebron	Elektriciteit
Bereidingswijze	Multifunctionele oven
Reinigingssysteem	Vapor Clean reiniging
EAN-code	8017709258160



Design

Design	Elementi	Type zeefdruk	Symbolen
Kleur	Zwart	Deur	Con 2 listelli
Design	Plat	Handvat	Elementi/ Selezione
Afwerking componenten	Inox	Kleur handvat	Squadrata
Materiaal	Glas	Logo	Inox look
Type roestvrijstaal	Geborsteld inox	Bedieningsknoppen	Geëst
Type glas	Clear1	Kleur bedieningsknoppen	Elementi
Kleur serigrafie	Grijs		Inox look

Bediening

			
Display	DigiScreen	Bediening	Knobs & touch buttons
Display	LED display	Aantal bedieningsknoppen	2

Programma's / Functies

Aantal kookfuncties	8
Automatische programma's	No
Individualiseerbare recepten	No

Traditionele bereidingsfuncties



Statisch



Statisch + ventilator



Circulatie (ventilator + circulaire)



Turbo: ventilator + circulaire +
statisch



ECO



Grote grill



Ventilator + grote grill



Onderwarmte

Overige functies



Ontdooien op tijd

Reinigingsfuncties



Vapor Clean reiniging

Opties



Tijdsinstelling

Automatische in- en
uitschakeling

Timer

1

Timer

Ja

Snel voorverwarmen

Ja

Technische specificaties



Inhoud (l)

72 l

Minimum temperatuur

50 °C

Maximum temperatuur

250 °C

Aantal kookniveaus

5

Dubbele ventilator

1

Aantal lampen

1

Type lamp

Halogeen

User-replaceable light

Ja

Vermogen lamp

40 W

Verlichting bij opening
deur

Ja

Onderwarmte -
vermogen

1200 W

Bovenwarmte -
vermogen

1000 W

Circulatie - vermogen

2000 W

Warmte onderbroken bij
openen deur

Ja

Opening deur

Standaard opening

Deur

Temperatuur
gecontroleerde deur

Uitneembare ovendeur

Ja

Volledig glazen
binnendeur

Ja

Uitneembaar glas
binnendeur

Ja

Totaal aantal ruiten

3

Koelsysteem

Mantelkoeling

Koelleiding

Enkel

Reductie snelheid
koelsysteem

Ja

Grill - vermogen	1700 W	Afmetingen bruikbare interne ovenruimte (hxbxd)	360x460x425 mm
Grote vlakgrill - vermogen	2700 W	Temperatuurcontrole	Elektro-mechanisch
		Materiaal ovenruimte	Ever Clean emaille

Prestaties / energielabel



Energie-efficiëntieklasse	A	Energy consumption in forced air convection	2,88 MJ
Netto volume	70 l	Energieconsumptie in turbo functie	0,80 kWh
Energieconsumptie in conventionele functie	1,15 kWh	Aantal ovens	1
Energy consumption in conventional mode	4,14 MJ	Energie-efficiëntie Index	95,2 %

Meegeleverde accessoires

Ovenrooster met stop	1	Bakplaat (40 mm)	1
----------------------	---	------------------	---

Elektrische aansluiting

Spanning	220-240 V	Nominale aansluitwaarde	3000 W
Stekker	Nee	Frequentie	50/60 Hz
Stroom	13 A	Lengte voedingskabel	115 cm

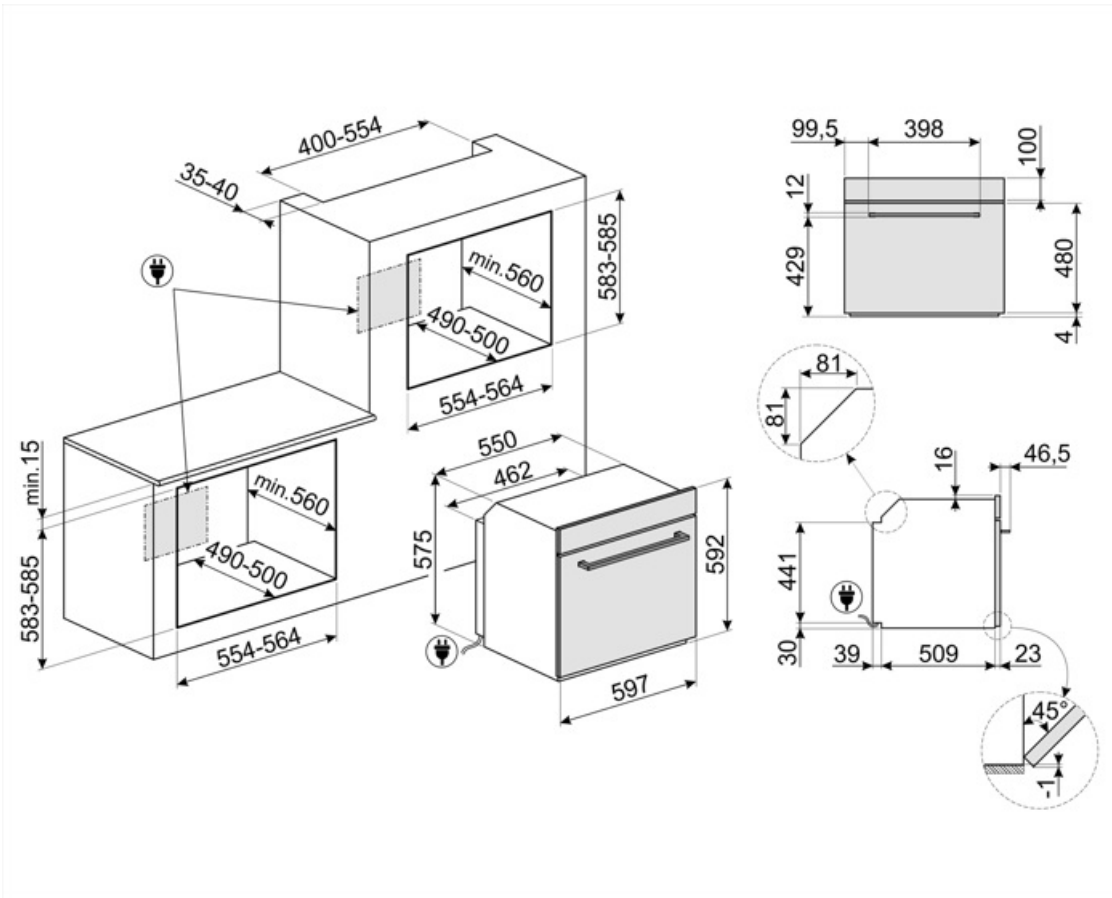

Compatible Accessories



BN620-1

Enamelled tray suitable for 45 cm and 60 cm ovens. Depth 20 mm. Perfect for a wide range of savoury and sweet baking.

GTP



Partially extractable telescopic guides (1 level), suitable for traditional ovens. Made in stainless steel, they guarantee stability and facilitate the smooth extraction of the trays.

PALPZ



Pizzapallet inox met ploibaar handvat, 315x325 mm

STONE2



Rectangular pizza stone without handles, suitable for 45cm and 60cm wide ovens. Dimensions W42 x H1.8 x D37.5cm. Ideal for cooking pizzas with the same results as a typical wood-fired oven. Can also be used for baking bread, focaccias and other recipes such as pies, flans or biscuits



BN640

Enamelled tray suitable for 45cm and 60cm ovens. Depth 540 mm. Perfect for cooking and roasting meat and fish in sauces. Also ideal for experimenting with lighter and crunchy side dishes

GTT

















Volledig uitschuifbare telescopische rails (1 niveau) voor traditionele ovens (SF-).









PR3845X



Inox profiel voor installatie ovens in kolom

Symbols glossary

 Energy efficiency class A	 Air cooling system: to ensure a safe surface temperatures.
 Defrost by time: Manual defrost function. At the end of the set duration, the function stops.	 Triple glazed doors: Number of glazed doors.
 Elektrische aansluiting	 Ever Clean Enamel: Ever Clean enamel is applied electrostatically, corner to corner and edge to edge to prevent cracking or cracks over time. It is a particular pyrolytic enamel, resistant to acids which, in addition to being pleasantly bright, promotes greater cleaning of the oven walls, thanks to its lower porosity. It is baked at over 850 °C and slowly polymerized at a scientifically determined rate to ensure uniform depth and strength. Ever Clean enamel creates an impeccable finish both on the inside of the oven and on the trays, making the surfaces of the oven incredibly easy to maintain over time as it reduces the adhesion of fat during cooking.
 Ventilator met bovenste en onderste elementen: De elementen in combinatie met de ventilator zijn bedoeld om een meer gelijkmatige warmte te bieden, een methode die vergelijkbaar is met conventioneel koken, dus voorverwarmen is vereist. Het meest geschikt voor items die langzaam koken vereisen.	 Alleen boven- en onder element: een traditionele kookmethode die het meest geschikt is voor losse items in het midden van de oven. de bovenkant van de oven zal altijd het heetst zijn. Ideaal voor gebraden vlees, fruitcake, brood etc.
 Base: the heat comes only from the bottom of the cavity. The fan is not active. Ideal for sweet and savory pies, cobblers and pizzas. Designed to complete cooking and make food more crunchy. This symbol in gas ovens indicates the gas burner.	 Circulaire: De combinatie van de ventilator en het ronde element eromheen zorgt voor een hete lucht kookmethode. Dit biedt vele voordelen, waaronder geen voorverwarmen als de kooktijd meer dan 20 minuten bedraagt, geen smaakoverdracht bij het gelijktijdig bereiden van verschillende soorten voedsel, minder energie en kortere kooktijden. Geschikt voor alle soorten voedsel.
 De combinatie van de grill, de ventilator en onderwarmte is interessant voor het bereiden van kleine hoeveelheden.	 Grill: Very intense heat coming only from above from a double heating element. The fan is not active. Provides excellent grilling and gratinating results. Used at the end of cooking, it gives a uniform browning to dishes.
 Fan grill: very intense heat coming only from above from a double heating element. The fan is active. It allows the optimal grilling of thickest meats. Ideal for large cuts of meat.	 Circulaire met bovenste en onderste elementen: door het gebruik van de ventilator met beide elementen kan voedsel snel en effectief worden gekookt, ideaal voor grote stukken vlees die grondig moeten worden gekookt. Het biedt een vergelijkbaar resultaat als rotisserie, waarbij de warmte rond het voedsel wordt verplaatst in plaats van het voedsel zelf te verplaatsen, waardoor elke maat of vorm kan worden gekookt.

-
- | | |
|---|---|
|  All glass inner door: All glass inner door, a single flat surface which is simple to keep clean. |  The inner door glass: can be removed with a few quick movements for cleaning. |
|  Side lights: Two opposing side lights increase visibility inside the oven. |  Rapid preheating: cooking is preceded by the preheating phase which allows the cooking compartment to reach the set temperature. This option reduces the time by up to 50%. |
|  The oven cavity has 5 different cooking levels. |  Vapor Clean: a simple cleaning function using steam to loosen deposits in the oven cavity. |
|  The capacity indicates the amount of usable space in the oven cavity in litres. |  The capacity indicates the amount of usable space in the oven cavity in litres. |
|  DIGI screen display + bedieningsknoppen | |