

# SF64M3VS



Category	60cm
Product Family	Oven
Power supply	Electric
Heat source	Electric
Cooking method	Fan assisted
EAN code	8017709256517



## Aesthetics

<b>Aesthetics</b>	Cucina	<b>Serigraphy type</b>	Symbols
<b>Colour</b>	Silver	<b>Door</b>	with 2 strips
<b>Design</b>	Flat	<b>Handle</b>	Squared Selection
<b>Component finish</b>	Stainless steel	<b>Handle Colour</b>	Steel effect
<b>Material</b>	Glass	<b>Logo</b>	Silk screen
<b>Type of steel</b>	Brushed	<b>Control knobs</b>	Cucina restyling
<b>Glass Type</b>	Stopsol	<b>Controls colour</b>	Steel effect
<b>Serigraphy colour</b>	Grey		

## Controls

Control setting	Control knobs	No. of controls	3
-----------------	---------------	-----------------	---

## Programs / Functions

No. of cooking functions 6

Traditional cooking functions



Static



Fan assisted



ECO



Large grill



Fan grill (large)



Fan assisted base

## Options

Time-setting options	Automatic end cooking	Timer	1
----------------------	-----------------------	-------	---

Minute minder Yes

## Technical Features



<b>Minimum Temperature</b>	50 °C	<b>Door</b>	Temperate door
<b>Maximum temperature</b>	250 °C	<b>Removable door</b>	Yes
<b>Shelf positions</b>	5	<b>Full glass inner door</b>	Yes
<b>No. of lights</b>	1	<b>Removable inner door</b>	Yes
<b>Light type</b>	Halogen	<b>Total no. of door glasses</b>	3
<b>User-replaceable light</b>	Yes	<b>Cooling system</b>	Tangential
<b>Light power</b>	40 W	<b>Cooling duct</b>	Single
<b>Lower heating element power</b>	1200 W	<b>Speed Reduction</b>	Yes
<b>Upper heating element - Power</b>	1000 W	<b>Cooling System</b>	
<b>Grill element - power</b>	1700 W	<b>Usable cavity space dimensions (HxWxD)</b>	360x460x425 mm
<b>Large grill - Power</b>	2700 W	<b>Temperature control</b>	Electro-mechanical
<b>Door opening type</b>	Standard opening	<b>Cavity material</b>	Easy clean enamel

## Performance / Energy Label



<b>Energy efficiency class</b>	A	<b>Energy consumption in forced air convection</b>	2.88 MJ
<b>Net volume of the cavity</b>	70 litres	<b>Energy consumption per cycle in fan-forced convection</b>	0.80 kWh
<b>Energy consumption per cycle in conventional mode</b>	1.15 kWh	<b>Number of cavities</b>	1
<b>Energy consumption in conventional mode</b>	4.14 MJ	<b>Energy efficiency index</b>	95.2 %

## Accessories Included

<b>Chrome shelf</b>	1	<b>Extra deep enamelled tray (40mm)</b>	1
---------------------	---	---	---

## Electrical Connection

<b>Voltage</b>	220-240 V	<b>Frequency (Hz)</b>	50/60 Hz
<b>Current</b>	13 A	<b>Power supply cable length</b>	115 cm
<b>Nominal power (W)</b>	3000 W		

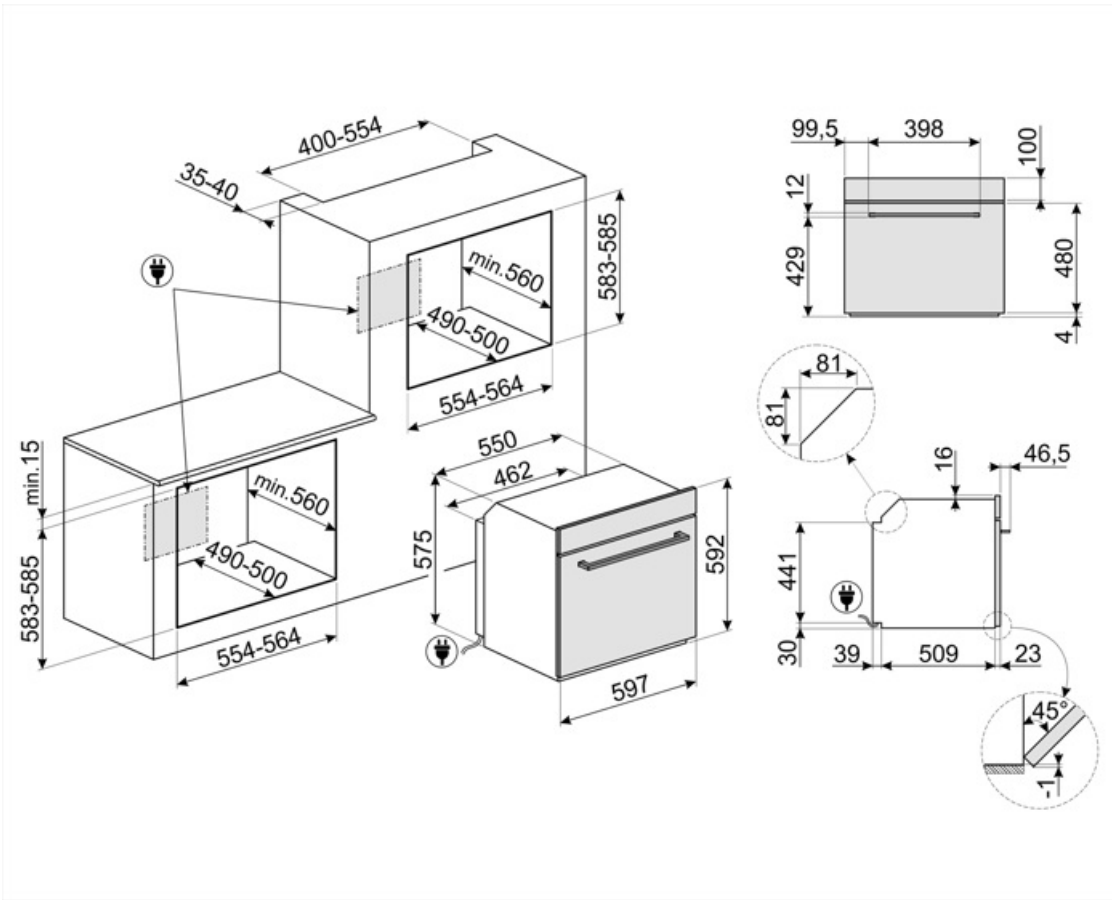

---

## Not included accessories

---

### GTP

\*\*Partially extractable telescopic guides (1 level)\*\* Extraction: 300 mm Material: Stainless steel AISI 430 polished



### PRTX

Refractory pizza stone with handles. D=35cm Not suitable for microwave ovens. Suitable for gas ovens, to be put on the griddle.



### PALPZ

Pizza shovel with fold away handle width: 315mm length : 325mm



### BN640

Enamelled tray, 40mm deep



### PR3845X

Antifingerprint stainless steel. Cover for furniture in column installation of more ovens



### BN620-1

Enamelled tray, 20mm deep



















### GTT

\*\*Totally extractable telescopic guides (1 level)\*\* Extraction: 433 mm Material: Stainless steel AISI 430 polished



## Symbols glossary

 <p>A: Product drying performance, measured from A+++ to D / G depending on the product family</p>	 <p>Air cooling system: to ensure a safe surface temperatures.</p>
 <p>Triple glazed doors: Number of glazed doors.</p>	 <p>Electric</p>
 <p>Enamel interior: The enamel interior of all Smeg ovens have a special antacid lining which helps keep the interior clean by reducing the amount of cooking grease adhering to it.</p>	 <p>Fan assisted base: the mix of fan and lower heating element alone allows to finish cooking foods already cooked on the surface but not internally more quickly. This system is recommended to finish cooking foods that are already well cooked on the surface, but not internally, which therefore require a moderate higher heat. Ideal for any type of food.</p>
 <p>Fan with upper and lower elements: The elements combined with the fan aim to provide more uniform heat, a similar method to conventional cooking, so pre-heat is required. Most suitable for items requiring slow cooking methods.</p>	 <p>Upper and lower element only: a traditional cooking method best suited for single items located in the centre of the oven. the top pf the oven will always be hottest. Ideal for roast, fruit cakes, bread etc.</p>
 <p>ECO: The combination of the grill, fan and lower element is particularly suitable for cooking small quantities of food.</p>	 <p>Grill element: Using of grill gives excellent results when cooking meat of medium and small portions, especially when combined with a rotisserie (where possible). Also ideal for cooking sausages and bacon.</p>
 <p>Fan with grill element: The fan reduces the fierce heat from the grill, providing an excellent method of grilling various foods, chops, steaks, sausages etc. giving even browning and heat distribution, without drying out the food. The top two levels recommended for use, and the lower part of the oven can be used to keep items warm at the same time, an excellent facility when cooking a grilled breakfast. Half grill (centre portion only) is ideal for small quantities of food.</p>	 <p>All glass inner door: All glass inner door, a single flat surface which is simple to keep clean.</p>
 <p>The inner door glass: can be removed with a few quick movements for cleaning.</p>	 <p>Side lights: Two opposing side lights increase visibility inside the oven.</p>
 <p>The oven cavity has 5 different cooking levels.</p>	 <p>The capacity indicates the amount of usable space in the oven cavity in litres.</p>