

# SF64M3VX



Category	60cm
Product Family	Oven
Power supply	Electric
Heat source	Electric
Cooking method	Fan assisted
EAN code	8017709262754



## Aesthetics

<b>Aesthetics</b>	Cucina	<b>Serigraphy type</b>	Symbols
<b>Colour</b>	Stainless steel	<b>Door</b>	With panel
<b>Finishing</b>	Fingerproof	<b>Handle</b>	Squared Selection
<b>Design</b>	Flat	<b>Handle Colour</b>	Steel effect
<b>Material</b>	Stainless steel	<b>Logo</b>	Embossed
<b>Type of steel</b>	Brushed	<b>Control knobs</b>	Cucina restyling
<b>Glass Type</b>	Eclipse	<b>Controls colour</b>	Steel effect
<b>Serigraphy colour</b>	Black		

## Controls

Control setting	Control knobs	No. of controls	3
-----------------	---------------	-----------------	---

## Programs / Functions

No. of cooking functions 6

Traditional cooking functions



Static



Fan assisted



ECO



Large grill



Fan grill (large)



Fan assisted base

## Options

Time-setting options	Automatic end cooking	Timer	1
----------------------	-----------------------	-------	---

Minute minder Yes

## Technical Features



Minimum Temperature	50 °C
Maximum temperature	250 °C
Shelf positions	5
No. of lights	1
Light type	Halogen
User-replaceable light	Yes
Light power	40 W
Lower heating element power	1200 W
Upper heating element - Power	1000 W
Grill element - power	1700 W
Large grill - Power	2700 W
Door opening type	Standard opening

Door	Temperate door
Removable door	Yes
Full glass inner door	Yes
Removable inner door	Yes
Total no. of door glasses	3
Cooling system	Tangential
Cooling duct	Single
Speed Reduction Cooling System	Yes
Usable cavity space dimensions (HxWxD)	360x460x425 mm
Temperature control	Electro-mechanical
Cavity material	Easy clean enamel

## Performance / Energy Label



Energy efficiency class	A
Net volume of the cavity	70 litres
Energy consumption per cycle in conventional mode	1.15 KWh
Energy consumption in conventional mode	4.14 MJ

Energy consumption in forced air convection	2.88 MJ
Energy consumption per cycle in fan-forced convection	0.80 KWh
Number of cavities	1
Energy efficiency index	95,2 %

## Accessories Included

Chrome shelf	1	Extra deep enamelled tray (40mm)	1
--------------	---	----------------------------------	---

## Electrical Connection

Voltage	220-240 V	Frequency (Hz)	50/60 Hz
Current	13 A	Power supply cable length	115 cm
Nominal power (W)	3000 W		

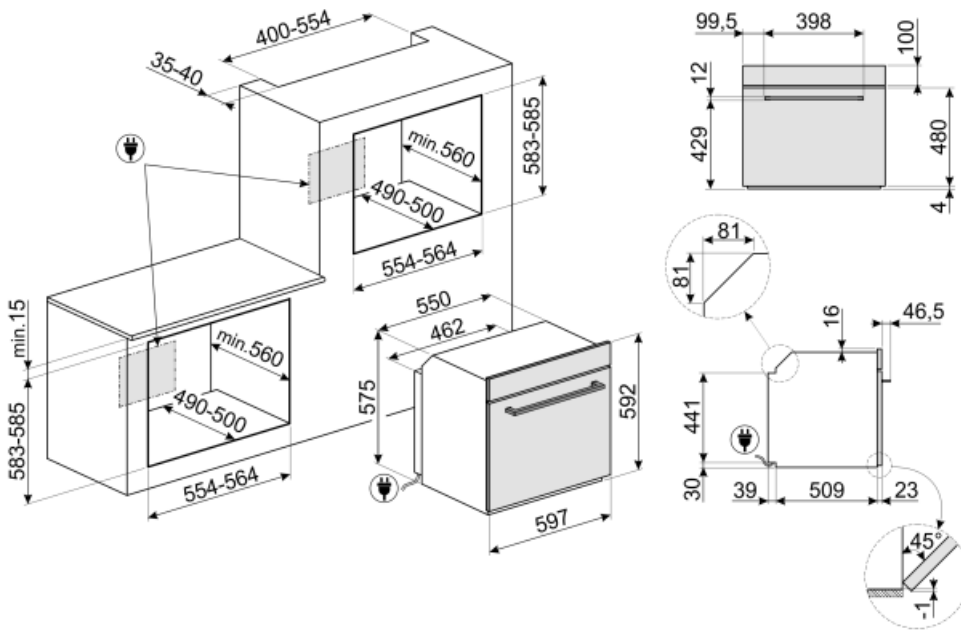

---

## Not included accessories

---

### GTP

\*\*Partially extractable telescopic guides (1 level)\*\* Extraction: 300 mm Material: Stainless steel AISI 430 polished



### PRTX

Refractory pizza stone with handles. D=35cm Not suitable for microwave ovens. Suitable for gas ovens, to be put on the griddle.



### PALPZ

Pizza shovel with fold away handle width: 315mm length : 325mm



### BN640

Enamelled tray, 40mm deep

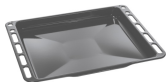

### PR3845X

Antifingerprint stainless steel. Cover for furniture in column installation of more ovens



### BN620-1

Enamelled tray, 20mm deep



















### GTT

\*\*Totally extractable telescopic guides (1 level)\*\* Extraction: 433 mm Material: Stainless steel AISI 430 polished



## Symbols glossary

 <p>A: Product drying performance, measured from A+++ to D / G depending on the product family</p>	 <p>Air cooling system: to ensure a safe surface temperatures.</p>
 <p>Triple glazed doors: Number of glazed doors.</p>	 <p>Electric</p>
 <p>Enamel interior: The enamel interior of all Smeg ovens have a special antacid lining which helps keep the interior clean by reducing the amount of cooking grease adhering to it.</p>	 <p>Fan assisted base: the mix of fan and lower heating element alone allows to finish cooking foods already cooked on the surface but not internally more quickly. This system is recommended to finish cooking foods that are already well cooked on the surface, but not internally, which therefore require a moderate higher heat. Ideal for any type of food.</p>
 <p>Fan with upper and lower elements: The elements combined with the fan aim to provide more uniform heat, a similar method to conventional cooking, so pre-heat is required. Most suitable for items requiring slow cooking methods.</p>	 <p>Upper and lower element only: a traditional cooking method best suited for single items located in the centre of the oven. the top pf the oven will always be hottest. Ideal for roast, fruit cakes, bread etc.</p>
 <p>ECO: The combination of the grill, fan and lower element is particularly suitable for cooking small quantities of food.</p>	 <p>Grill element: Using of grill gives excellent results when cooking meat of medium and small portions, especially when combined with a rotisserie (where possible). Also ideal for cooking sausages and bacon.</p>
 <p>Fan with grill element: The fan reduces the fierce heat from the grill, providing an excellent method of grilling various foods, chops, steaks, sausages etc. giving even browning and heat distribution, without drying out the food. The top two levels recommended for use, and the lower part of the oven can be used to keep items warm at the same time, an excellent facility when cooking a grilled breakfast. Half grill (centre portion only) is ideal for small quantities of food.</p>	 <p>All glass inner door: All glass inner door, a single flat surface which is simple to keep clean.</p>
 <p>The inner door glass: can be removed with a few quick movements for cleaning.</p>	 <p>Side lights: Two opposing side lights increase visibility inside the oven.</p>
 <p>The oven cavity has 5 different cooking levels.</p>	 <p>The capacity indicates the amount of usable space in the oven cavity in litres.</p>