

SF6905N1



Categorie	60 cm
Product familie	Oven
Stroomvoorziening	Elektrisch
Warmtebron	Elektriciteit
Bereidingswijze	Multifunctionele oven
Reinigingssysteem	Vapor Clean reiniging
EAN-code	8017709241537



Design

Design	Victoria	Deur	Met paneel
Kleur	Zwart	Handvat	Victoria
Design	Bol	Kleur handvat	Inox look
Materiaal	Gelakt materiaal	Logo	Geassembleerd
Type glas	Clear1	Bedieningsknoppen	Victoria
Kleur serigrafie	Wit	Kleur bedieningsknoppen	Inox look
Type zeefdruk	Symbolen		









Bediening

Bediening	Bedieningsknoppen	Aantal bedieningsknoppen	3
------------------	-------------------	---------------------------------	---

Programma's / Functies

Aantal kookfuncties	8
----------------------------	---

Traditionele bereidingsfuncties

 Statisch	 Statisch + ventilator	 Circulatie (ventilator + circulaire)
 Turbo: ventilator + circulaire + statisch	 ECO	 Grote grill
 Ventilator + grote grill	 Onderwarmte	

Reinigingsfuncties

 Vapor Clean reiniging
--

Opties

Tijdsinstelling	Einde kooktijd	Timer	Ja
-----------------	----------------	-------	----

Technische specificaties



Inhoud (l)	70 l	Warmte onderbroken bij openen deur	Ja
Minimum temperatuur	60 °C	Opening deur	Standaard opening
Maximum temperatuur	250 °C	Deur	Temperatuur gecontroleerde deur
Aantal kookniveaus	5	Uitneembare ovendeur	Ja
Dubbele ventilator	1	Volledig glazen binnendeur	Ja
Aantal lampen	2	Uitneembaar glas binnendeur	Ja
Type lamp	Halogeen	Totaal aantal ruiten	3
Vermogen lamp	40 W	Koelsysteem	Mantelkoeling
Verlichting bij opening deur	Ja	Koelleiding	Dubbel
Onderwarmte - vermogen	1200 W	Reductie snelheid koelsysteem	Ja
Bovenwarmte - vermogen	1000 W	Afmetingen bruikbare interne ovenruimte (hxbxd)	360x460x425 mm
Grill - vermogen	1700 W	Temperatuurcontrole	Elektro-mechanisch
Grote vlakgrill - vermogen	2700 W		
Circulatie - vermogen	2000 W		

Prestaties / energielabel



Energie-efficiëntieklasse	A	Energy consumption in forced air convection	2,88 MJ
Netto volume	70 l	Energieconsumptie in turbo functie	0,80 kWh
Energieconsumptie in conventionele functie	1,15 kWh	Aantal ovens	1
Energy consumption in conventional mode	4,14 MJ	Energie-efficiëntie Index	95,2 %

Meegeleverde accessoires

Ovenrooster met stop	1	Bakplaat (40 mm)	1
----------------------	---	------------------	---

Elektrische aansluiting

Spanning	220-240 V	Nominale aansluitwaarde	3000 W
Stekker	Nee	Frequentie	50/60 Hz
Stroom	13 A	Lengte voedingskabel	150 cm

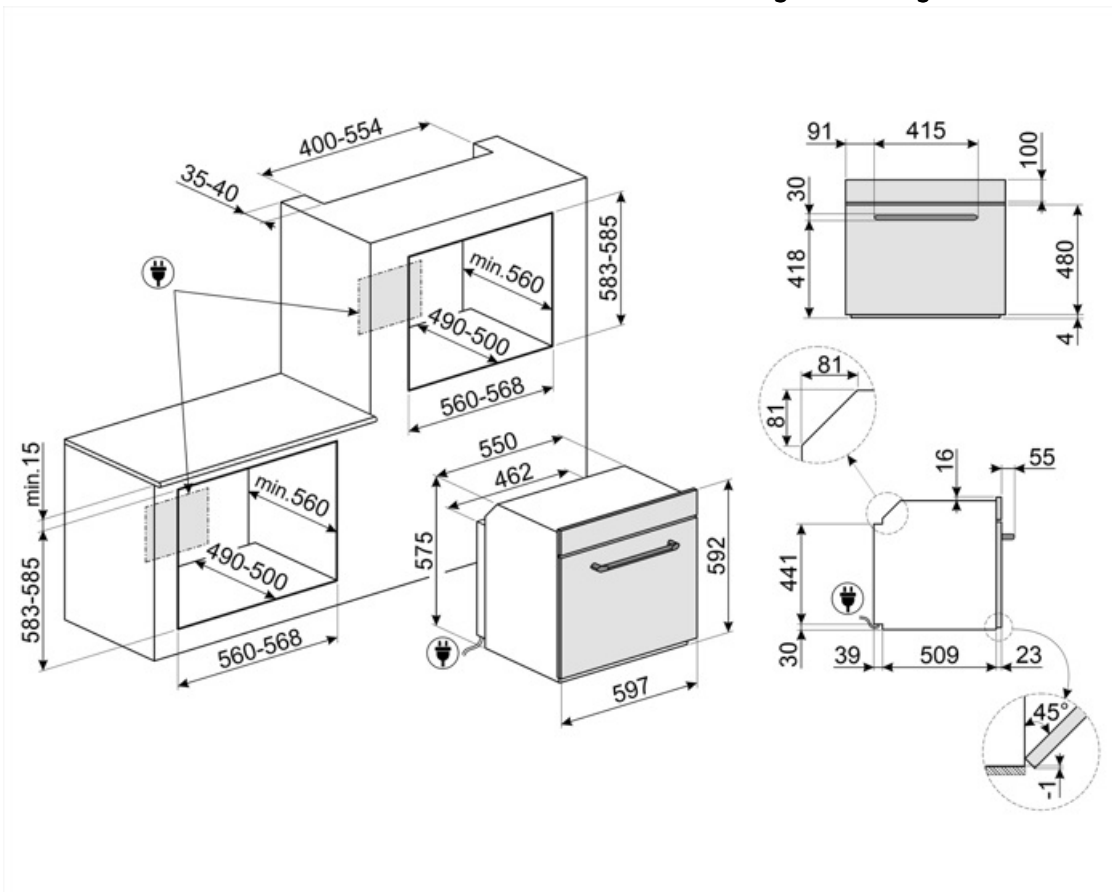

Compatible Accessories



BN620-1

Enamelled tray suitable for 45 cm and 60 cm ovens. Depth 20 mm. Perfect for a wide range of savoury and sweet baking.

GTP



Partially extractable telescopic guides (1 level), suitable for traditional ovens. Made in stainless steel, they guarantee stability and facilitate the smooth extraction of the trays.

PALPZ



Pizzapallet inox met ploibaar handvat, 315x325 mm

STONE2



Rectangular pizza stone without handles, suitable for 45cm and 60cm wide ovens. Dimensions W42 x H1.8 x D37.5cm. Ideal for cooking pizzas with the same results as a typical wood-fired oven. Can also be used for baking bread, focaccias and other recipes such as pies, flans or biscuits



BN640

Enamelled tray suitable for 45cm and 60cm ovens. Depth 540 mm. Perfect for cooking and roasting meat and fish in sauces. Also ideal for experimenting with lighter and crunchy side dishes

GTT



Volledig uitschuifbare telescopische rails (1 niveau) voor traditionele ovens (SF-).

PR3845X



Inox profiel voor installatie ovens in kolom

Alternative products



SF6905X1

















Inox



SF6905P1

Crème

Symbols glossary

 Energy efficiency class A	 Air cooling system: to ensure a safe surface temperatures.
 Triple glazed doors: Number of glazed doors.	 Elektrische aansluiting
 Ever Clean Enamel: Ever Clean enamel is applied electrostatically, corner to corner and edge to edge to prevent cracking or cracks over time. It is a particular pyrolytic enamel, resistant to acids which, in addition to being pleasantly bright, promotes greater cleaning of the oven walls, thanks to its lower porosity. It is baked at over 850 °C and slowly polymerized at a scientifically determined rate to ensure uniform depth and strength. Ever Clean enamel creates an impeccable finish both on the inside of the oven and on the trays, making the surfaces of the oven incredibly easy to maintain over time as it reduces the adhesion of fat during cooking.	 Ventilator met bovenste en onderste elementen: De elementen in combinatie met de ventilator zijn bedoeld om een meer gelijkmatige warmte te bieden, een methode die vergelijkbaar is met conventioneel koken, dus voorverwarmen is vereist. Het meest geschikt voor items die langzaam koken vereisen.
 Alleen boven- en onder element: een traditionele kookmethode die het meest geschikt is voor losse items in het midden van de oven. de bovenkant van de oven zal altijd het heetst zijn. Ideaal voor gebraden vlees, fruitcake, brood etc.	 Base: the heat comes only from the bottom of the cavity. The fan is not active. Ideal for sweet and savory pies, cobblers and pizzas. Designed to complete cooking and make food more crunchy. This symbol in gas ovens indicates the gas burner.
 Circulaire: De combinatie van de ventilator en het ronde element eromheen zorgt voor een hete lucht kookmethode. Dit biedt vele voordelen, waaronder geen voorverwarmen als de kooktijd meer dan 20 minuten bedraagt, geen smaakoverdracht bij het gelijktijdig bereiden van verschillende soorten voedsel, minder energie en kortere kooktijden. Geschikt voor alle soorten voedsel.	 De combinatie van de grill, de ventilator en onderwarmte is interessant voor het bereiden van kleine hoeveelheden.
 Grill: Very intense heat coming only from above from a double heating element. The fan is not active. Provides excellent grilling and gratinating results. Used at the end of cooking, it gives a uniform browning to dishes.	 Fan grill: very intense heat coming only from above from a double heating element. The fan is active. It allows the optimal grilling of thickest meats. Ideal for large cuts of meat.
 Circulaire met bovenste en onderste elementen: door het gebruik van de ventilator met beide elementen kan voedsel snel en effectief worden gekookt, ideaal voor grote stukken vlees die grondig moeten worden gekookt. Het biedt een vergelijkbaar resultaat als rotisserie, waarbij de warmte rond het voedsel wordt verplaatst in plaats van het voedsel zelf te verplaatsen, waardoor elke maat of vorm kan worden gekookt.	 All glass inner door: All glass inner door, a single flat surface which is simple to keep clean.
 The inner door glass: can be removed with a few quick movements for cleaning.	 Side lights: Two opposing side lights increase visibility inside the oven.



The oven cavity has 5 different cooking levels.



Vapor Clean: a simple cleaning function using steam to loosen deposits in the oven cavity.



The capacity indicates the amount of usable space in the oven cavity in litres.



The capacity indicates the amount of usable space in the oven cavity in litres.