

# SF7390X

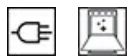

Category	70cm
Product Family	Oven
Power supply	Electric
Heat source	ELECTRICITY
Cooking method	Thermo-ventilated
Cleaning system	Ever Clean enamel
EAN code	8017709212230



## Aesthetics

Aesthetic	Classica	Serigraphy type	Symbols
Colour	Stainless steel	Door	With 2 horizontal strips
Finishing	Fingerproof	Handle	Classic
Design	Flat	Handle Colour	Inox
Material	Stainless steel	Logo	Embossed
Type of steel	Brushed	Control knobs	Classic
Glass Type	Eclipse	Controls colour	Steel effect
Serigraphy colour	Black		

## Controls











Display name	CompactScreen	Control setting	Knobs
Display technology	LCD	No. of controls	2





## Programs / Functions

No. of cooking functions	9
Automatic programmes	20

## Traditional cooking functions

 Static	 Fan assisted	 Circulaire
 Turbo	 Eco	 Large grill
 Fan grill (large)	 Base	 Fan assisted base

## Other functions

 Defrost by time	 Defrost by weight	 Leavening
 Sabbath		

## Cleaning functions

 Vapor Clean
--

## Options



<b>Time-setting options</b>	Delay start and automatic end cooking	<b>Other options</b>	Keep warm, Eco light
<b>Minute minder</b>	Yes	<b>Showroom demo option</b>	Yes
<b>Controls Lock / Child Safety</b>	Yes	<b>Rapid pre-heating</b>	Yes

## Technical Features



<b>Minimum Temperature</b>	30 °C	<b>Heating suspended when door is opened</b>	Yes
<b>Maximum temperature</b>	280 °C	<b>Door</b>	Fresh Touch
<b>No. of shelves</b>	4	<b>Removable door</b>	Yes
<b>N. of fans</b>	1	<b>Full glass inner door</b>	Yes
<b>No. of lights</b>	2	<b>Removable inner door</b>	Yes
<b>Light type</b>	Incandescent	<b>Total no. of door glasses</b>	3
<b>Light Power</b>	25 W	<b>Cooling system</b>	Tangential
<b>Light when door is opened</b>	Yes	<b>Cooling duct</b>	Double
<b>Lower heating element power</b>	1750 W	<b>Speed Reduction Cooling System</b>	Yes
<b>Upper heating element - Power</b>	1300 W	<b>Usable cavity space dimensions (HxWxD)</b>	305x613x405 mm
<b>Grill element - power</b>	1600 W	<b>Temperature control</b>	Electronic
<b>Large grill - Power</b>	2900 W	<b>Cavity material</b>	Ever clean Enamel
<b>Circular heating element - Power</b>	2000 W		

## Performance / Energy Label



Energy efficiency class	A	Energy consumption in forced air convection	2.99 MJ
Net volume of the cavity	77 l	Energy consumption per cycle in fan-forced convection	0.83 kWh
Energy consumption per cycle in conventional mode	1.39 kWh	Number of cavities	1
Energy consumption in conventional mode	5.00 MJ	Energy efficiency index	95,4 %

## Accessories Included

Rack with back stop	1	Insert grid	1
Enamelled tray (20mm)	2		

## Electrical Connection

Plug	Not present	Nominal power	3200 W
Voltage	220-240 V	Frequency (Hz)	50/60 Hz
Current	14 A	Power supply cable length	150 cm

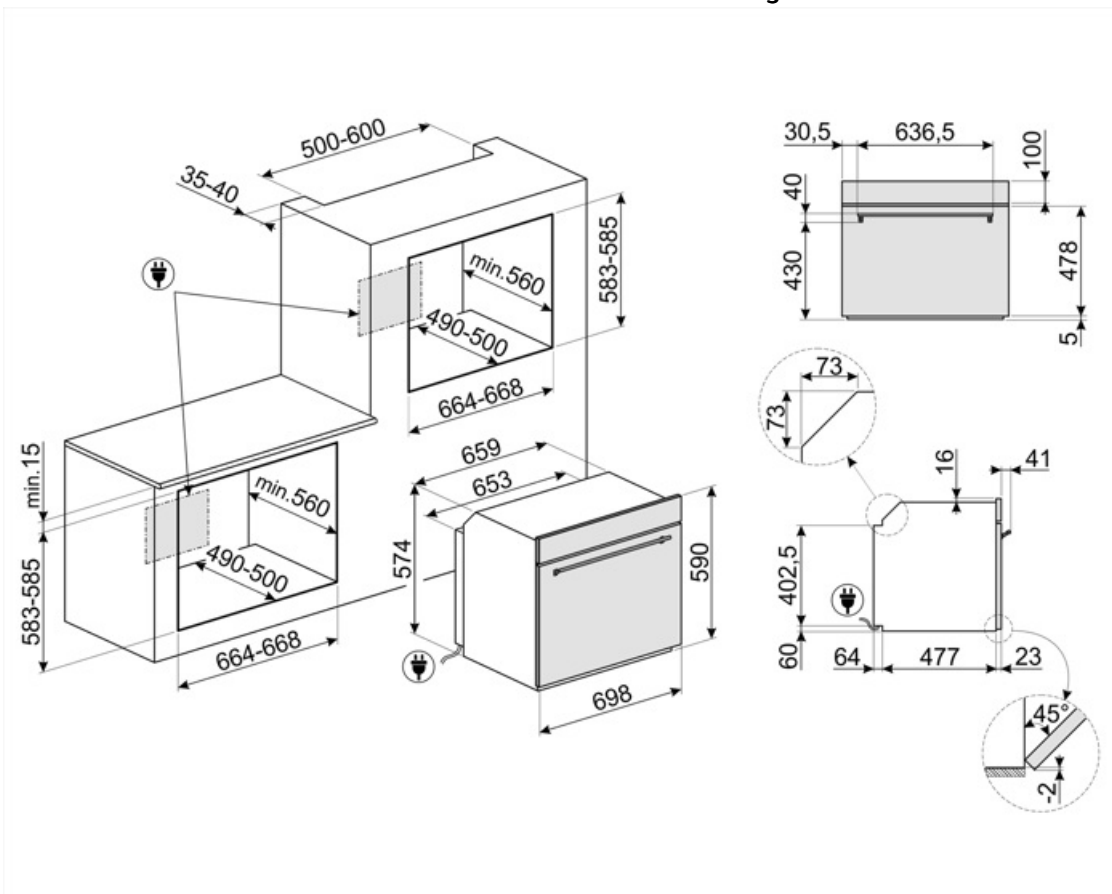

---

## Not included accessories

---



### PRTX















Refractory pizza stone with handles. D=35cm Not suitable for microwave ovens. Suitable for gas ovens, to be put on the griddle.



















### PALPZ

Pizza shovel with folding handle. Dimensions L31.5 x H32.5 cm. Easy and convenient to use and store. Perfect for serving pizza, bread and savory pastries in a safe and professional way.

## Symbols glossary (TT)

 <p>Child lock: some models are fitted with a device to lock the programme/cycle so it cannot be accidentally changed.</p>	
 <p>Air cooling system: to ensure a safe surface temperatures.</p>	 <p>Defrost by time: Manual defrost function. At the end of the set duration, the function stops.</p>
 <p>Defrost by weight: Automatic defrost function. You choose the type of food to defrost from the available categories (MEAT - FISH - BREAD - DESSERTS) After entering the weight of the food, the oven automatically defines the time required for proper defrosting.</p>	 <p>With a simple and intuitive interface, the COMPACTscreen provides a pleasant user experience, thanks to the interaction with the knobs.</p>
 <p>Triple glazed doors: Number of glazed doors.</p>	 <p>Automatic lighting deactivation: For greater energy savings, the lighting turns off automatically after one minute from the start of cooking. The option can be disabled via the settings menu. In this case the light will remain on for the entire duration of cooking.</p>
 <p>Electric</p>	 <p>Ever Clean Enamel: Ever Clean enamel is applied electrostatically, corner to corner and edge to edge to prevent cracking or cracks over time. It is a particular pyrolytic enamel, resistant to acids which, in addition to being pleasantly bright, promotes greater cleaning of the oven walls, thanks to its lower porosity. It is baked at over 850 ° C and slowly polymerized at a scientifically determined rate to ensure uniform depth and strength. Ever Clean enamel creates an impeccable finish both on the inside of the oven and on the trays, making the surfaces of the oven incredibly easy to maintain over time as it reduces the adhesion of fat during cooking.</p>
 <p>Fresh Touch: Most of Smeg ovens have a "cool door." Thanks to the combination of tangential cooling and internal heat-reflecting glasses, the temperature on the outer surface of the door is maintained below 50° C. In addition to providing safety, this system protects the sides of the furniture from overheating by the oven.</p>	 <p>Fan assisted base: the mix of fan and lower heating element alone allows to finish cooking foods already cooked on the surface but not internally more quickly. This system is recommended to finish cooking foods that are already well cooked on the surface, but not internally, which therefore require a moderate higher heat. Ideal for any type of food.</p>
 <p>Fan assisted: Intense and homogeneous traditional cooking, also suitable for complex recipes. The fan is active and the heat comes from below and from above at the same time. Ventilated cooking ensures a faster and more homogeneous result, leaving fragrant foods outside and moister inside. Ideal for baked pasta, biscuits, roasts and cobblers.</p>	 <p>Static: Traditional cooking suitable for the preparation of one dish at a time. The fan is not active and the heat comes from below and from above at the same time. Static cooking is slower and more delicate, ideal in order to get well cooked and dry dishes even inside. Ideal for cooking all types of roasts, fatty meats, bread, filled cakes.</p>

-  **Base:** the heat comes only from the bottom of the cavity. The fan is not active. Ideal for sweet and savory pies, cobblers and pizzas. Designed to complete cooking and make food more crunchy. This symbol in gas ovens indicates the gas burner.
-  **ECO:** low energy consumption cooking: this function is particularly suitable for cooking on a single shelf with low energy consumption. It is recommended for all types of food except those that can generate a lot of moisture (for example vegetables). To achieve maximum energy savings and reduce time, it is recommended to put the food in the oven without preheating the cooking compartment.
-  **Fan grill:** very intense heat coming only from above from a double heating element. The fan is active. It allows the optimal grilling of thickest meats. Ideal for large cuts of meat.
-  **All glass inner door:** All glass inner door, a single flat surface which is simple to keep clean.
-  **KEEP\_WARM\_72dpi**
-  **Air at 40°C** provides the perfect environment for proving yeast type dough mixes. Simply select the function and place dough in the cavity for allotted.
-  **SABBATH:** function that allows to cook food respecting Judaism's day of rest provisions.
-  **Electronic control:** Allows you to maintain temperature inside the oven with the precision 2-3 ° C. This enables to cook meals that are very sensitive to temperature changes, such as cakes, souffles, puddings.
-  **77L** The capacity indicates the amount of usable space in the oven cavity in litres.
-  **Circulaire:** it is the perfect function for cooking all types of dishes in a more delicate way. The heat comes from the back of the oven and is distributed quickly and evenly. The fan is active. It is also ideal for cooking on multiple levels without mixing smells and flavors.
-  **Grill:** Very intense heat coming only from above from a double heating element. The fan is not active. Provides excellent grilling and gratinating results. Used at the end of cooking, it gives a uniform browning to dishes.
-  **Turbo:** the heat comes from 3 directions: above, below and from the back of the oven. The fan is active. It allows quick cooking, even on several shelves without mixing the aromas. Ideal for large volumes or foods that require intense cooking.
-  **The inner door glass:** can be removed with a few quick movements for cleaning.
-  **ECO-logic:** option allows you to restrict the power limit of the appliance real energy saving.
-  **Rapid preheating:** cooking is preceded by the preheating phase which allows the cooking compartment to reach the set temperature. This option reduces the time by up to 50%.
-  **4** The oven cavity has 4 different cooking levels.
-  **V** **Vapor Clean:** a simple cleaning function using steam to loosen deposits in the oven cavity.