

SF800AO

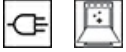

Category	60cm
Product Family	Oven
Power supply	Electric
Heat source	ELECTRICITY
Cooking method	Fan assisted
Cleaning system	Ever Clean enamel
EAN code	8017709171896



Aesthetics







Aesthetic	Coloniale	Door	With panel
Colour	Anthracite	Handle	Colonial
Design	Flat	Handle Colour	Antique brass
Component finish	Antique brass	Logo	Silk screen
Material	Painted material	Control knobs	Colonial
Glass Type	Clear	Controls colour	Brassed
Serigraphy colour	Gold		

Controls

Control setting	Knobs	No. of controls	2
-----------------	-------	-----------------	---

Programs / Functions main oven

No. of cooking functions	6
Traditional cooking functions	

 Static	 Fan assisted	 Eco
 Large grill	 Fan grill (large)	 Fan assisted base

Options

Time-setting options	Automatic end cooking	Minute minder	Yes
----------------------	-----------------------	---------------	-----

Technical Features



Minimum Temperature	50 °C
Maximum temperature	250 °C
No. of shelves	5
N. of fans	1
No. of lights	1
Light type	Halogen
Light Power	40 W
Lower heating element power	1200 W
Upper heating element - Power	1000 W
Grill element - power	1700 W
Large grill - Power	2700 W

Door opening type	Standard opening
Door	Temperate door
Removable door	Yes
Full glass inner door	Yes
Removable inner door	Yes
Total no. of door glasses	3
Cooling system	Tangential
Cooling duct	Single
Usable cavity space dimensions (HxWxD)	360x460x425 mm
Temperature control	Electro-mechanical
Cavity material	Ever clean Enamel

Performance / Energy Label



Energy efficiency class	A
Net volume of the cavity	70 l
Energy consumption per cycle in conventional mode	1.15 KWh
Energy consumption in conventional mode	4.14 MJ

Energy consumption in forced air convection	2.88 MJ
Energy consumption per cycle in fan-forced convection	0.80 KWh
Number of cavities	1
Energy efficiency index	95,2 %

Accessories included

Rack with back stop	1	Enamelled deep tray (40mm)	1
---------------------	---	----------------------------	---

Electrical Connection

Plug	Not present	Voltage 2	
Voltage	220-240 V	Frequency (Hz)	50 Hz
Current	13 A	Power supply cable length	150 cm
Nominal power	3000 W		

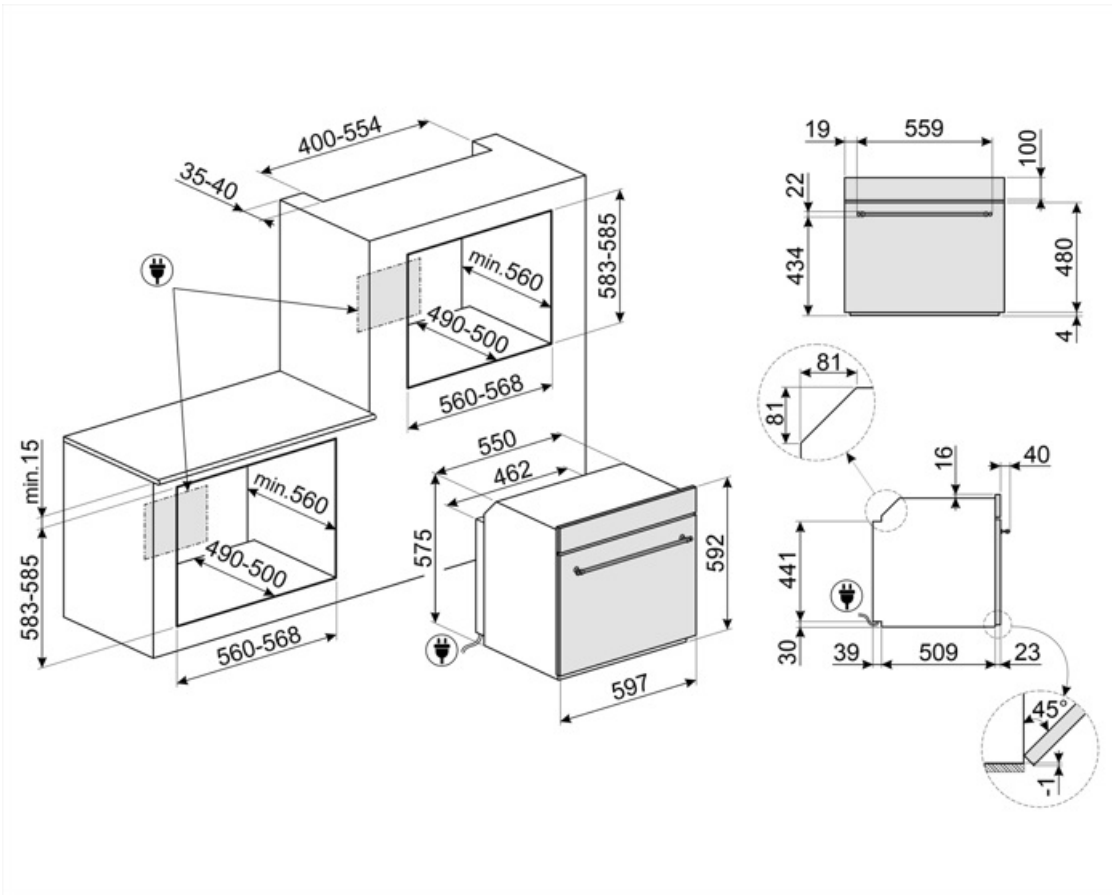

Compatible Accessories



BN620-1

Enamelled tray suitable for 45cm and 60cm ovens. Depth 20 mm. Perfect for a wide range of savoury and sweet baking.

GTP



Partially extractable telescopic guides (1 level), suitable for traditional ovens. Made in stainless steel, they guarantee stability and facilitate the smooth extraction of the trays.

PALPZ



Pizza shovel with folding handle. Dimensions L31.5 x H32.5 cm. Easy and convenient to use and store. Perfect for serving pizza, bread and savory pastries in a safe and professional way.



BN640

Enamelled tray suitable for 45cm and 60cm ovens. Depth 540 mm. Perfect for cooking and roasting meat and fish in sauces. Also ideal for experimenting with lighter and crunchy side dishes

GTT



Totally extractable telescopic guides (1 level), suitable for traditional ovens. Made in stainless steel, they guarantee stability and facilitate the smooth extraction of the trays.

PR3845X



Antifingerprint stainless steel. Cover for furniture in column installation of more ovens

Alternative products



SF800AVO

Oats



SF800B

















White



SF800PO

Cream

Symbols glossary

		 <p>Air cooling system: to ensure a safe surface temperatures.</p>
 <p>Triple glazed doors: Number of glazed doors.</p>	 <p>Electric</p>	
 <p>Ever Clean Enamel: Ever Clean enamel is applied electrostatically, corner to corner and edge to edge to prevent cracking or cracks over time. It is a particular pyrolytic enamel, resistant to acids which, in addition to being pleasantly bright, promotes greater cleaning of the oven walls, thanks to its lower porosity. It is baked at over 850 ° C and slowly polymerized at a scientifically determined rate to ensure uniform depth and strength Ever Clean enamel creates an impeccable finish both on the inside of the oven and on the trays, making the surfaces of the oven incredibly easy to maintain over time as it reduces the adhesion of fat during cooking</p>	 <p>Fan assisted base: the mix of fan and lower heating element alone allows to finish cooking foods already cooked on the surface but not internally more quickly. This system is recommended to finish cooking foods that are already well cooked on the surface, but not internally, which therefore require a moderate higher heat. Ideal for any type of food.</p>	
 <p>Fan assisted: Intense and homogeneous traditional cooking, also suitable for complex recipes. The fan is active and the heat comes from below and from above at the same time. Ventilated cooking ensures a faster and more homogeneous result, leaving fragrant foods outside and moister inside. Ideal for baked pasta, biscuits, roasts and cobblers.</p>	 <p>Static: Traditional cooking suitable for the preparation of one dish at a time. The fan is not active and the heat comes from below and from above at the same time. Static cooking is slower and more delicate, ideal in order to get well cooked and dry dishes even inside. Ideal for cooking all types of roasts, fatty meats, bread, filled cakes.</p>	
 <p>ECO: low energy consumption cooking: this function is particularly suitable for cooking on a single shelf with low energy consumption. It is recommended for all types of food except those that can generate a lot of moisture (for example vegetables). To achieve maximum energy savings and reduce time, it is recommended to put the food in the oven without preheating the cooking compartment</p>	 <p>Grill: Very intense heat coming only from above from a double heating element. The fan is not active. Provides excellent grilling and gratinating results. Used at the end of cooking, it gives a uniform browning to dishes.</p>	
 <p>Fan grill: very intense heat coming only from above from a double heating element The fan is active. It allows the optimal grilling of thickest meats. Ideal for large cuts of meat.</p>	 <p>All glass inner door: All glass inner door, a single flat surface which is simple to keep clean.</p>	
 <p>The inner door glass: can be removed with a few quick movements for cleaning.</p>	 <p>Side lights: Two opposing side lights increase visibility inside the oven.</p>	
 <p>The oven cavity has 5 different cooking levels.</p>	 <p>The capacity indicates the amount of usable space in the oven cavity in litres.</p>	
 <p>The capacity indicates the amount of usable space in the oven cavity in litres.</p>		