

# SFA6301TX



Category	60cm
Product Family	Oven
Power supply	Electric
Heat source	ELECTRICITY
Cooking method	Thermoseal
Cleaning system	Vapour Clean
EAN code	8017709329280



## Aesthetics

<b>Aesthetic</b>	Classic	<b>Serigraphy type</b>	Symbols
<b>Colour</b>	Stainless steel	<b>Door</b>	With 2 horizontal strips
<b>Finishing</b>	Fingerproof	<b>Handle</b>	Classic
<b>Design</b>	Flat	<b>Handle Colour</b>	Inox
<b>Material</b>	Stainless steel	<b>Logo</b>	Embossed
<b>Type of steel</b>	Brushed	<b>Control knobs</b>	Classic
<b>Glass Type</b>	Eclipse	<b>Controls colour</b>	Steel effect
<b>Serigraphy colour</b>	Black		

## Controls



<b>Display name</b>	CompactScreen	<b>Control setting</b>	Knobs
<b>Display technology</b>	LCD	<b>No. of controls</b>	2

## Programs / Functions

<b>No. of cooking functions</b>	10
---------------------------------	----

### Traditional cooking functions

Static	Fan assisted	Circulaire
Turbo	Eco	Large grill
Fan grill (large)	Base	Circulaire + bottom
Pizza		

### Other functions

Defrost by time	Proving	Sabbath
-----------------	---------	---------

### Cleaning functions

Vapour Clean
--------------

## Options



<b>Time-setting options</b>	Delay start and automatic end cooking
<b>Minute minder</b>	Yes
<b>Timer</b>	1

<b>Other options</b>	Keep warm
<b>Rapid pre-heating</b>	Yes

## Technical Features



<b>Cavity</b>	Sares	<b>Heating suspended when door is opened</b>	Yes
<b>Minimum Temperature</b>	30 °C	<b>Door opening type</b>	Standard opening
<b>Maximum temperature</b>	280 °C	<b>Door</b>	Temperate door
<b>No. of shelves</b>	5	<b>Removable door</b>	Yes
<b>N. of fans</b>	1	<b>Full glass inner door</b>	Yes
<b>No. of lights</b>	1	<b>Removable inner door</b>	Yes
<b>Light type</b>	Halogen	<b>Total no. of door glasses</b>	3
<b>User-replaceable light</b>	Yes	<b>Cooling system</b>	Tangential
<b>Light Power</b>	40 W	<b>Cooling duct</b>	Single
<b>Light when door is opened</b>	Yes	<b>Usable cavity space dimensions (HxWxD)</b>	360x460x425 mm
<b>Lower heating element power</b>	1200 W	<b>Temperature control</b>	Electronic
<b>Grill element - power</b>	1800 W	<b>Cavity material</b>	Ever clean Enamel
<b>Circular heating element - Power</b>	2000 W		

## Performance / Energy Label

Number of cavities 1

## Accessories Included

Rack with back stop 1

Enamelled deep tray (40mm) 1

## Electrical Connection

Voltage 220-240 V  
 Plug (I) Australia  
 Current 13 A

Nominal power 3000 W  
 Frequency (Hz) 50/60 Hz  
 Power supply cable length 150 cm

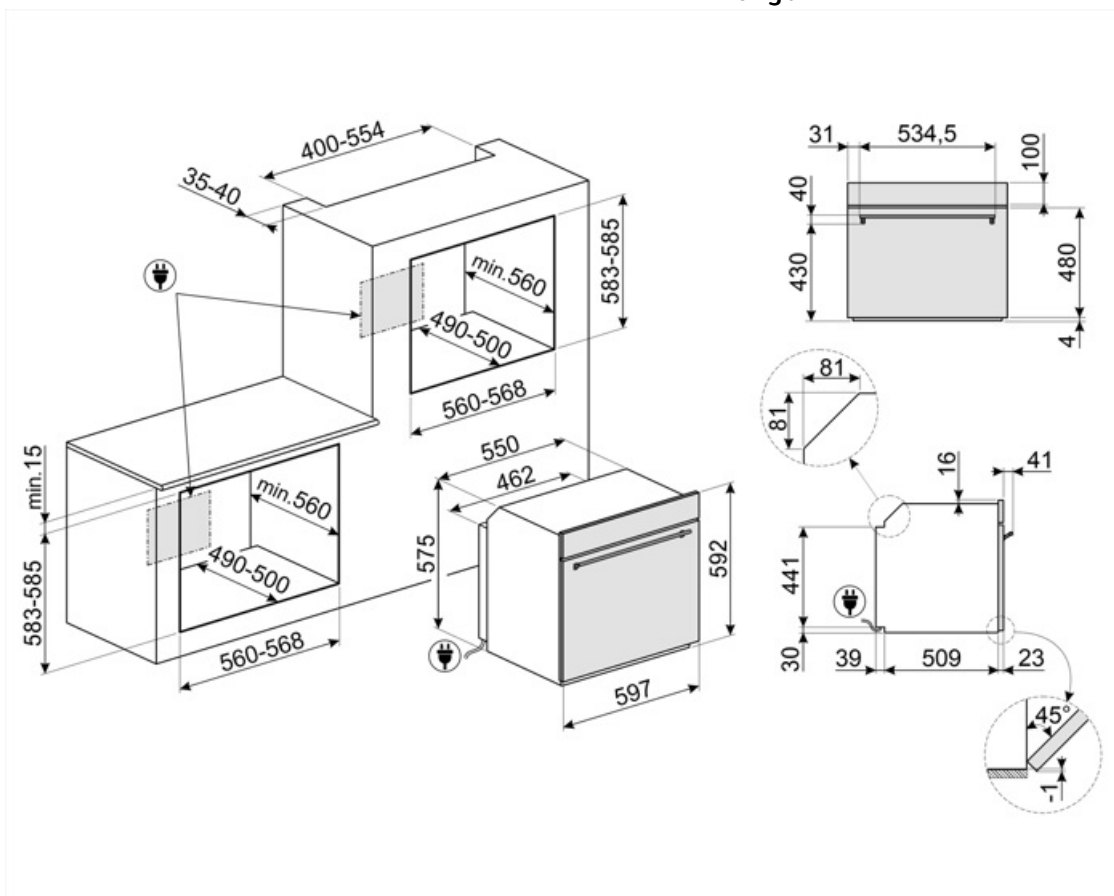

## Compatible Accessories

### BN620-1

Enamelled tray, 20mm deep



### GTP

\*\*Partially extractable telescopic guides (1 level)\*\* Extraction: 300 mm Material: Stainless steel AISI 430 polished



### PALPZ

Pizza shovel with fold away handle width: 315mm length : 325mm



### STONE2

Rectangular pizza stone without handles, suitable for 45cm and 60cm wide ovens. Dimensions W42 x H1.8 x D37.5cm. Ideal for cooking pizzas with the same results as a typical wood-fired oven. Can also be used for baking bread, focaccias and other recipes such as pies, flans or biscuits



### BN640

Enamelled tray, 40mm deep



### GTT

\*\*Totally extractable telescopic guides (1 level)\*\* Extraction: 433 mm Material: Stainless steel AISI 430 polished































### PR3845X

Antifingerprint stainless steel. Cover for furniture in column installation of more ovens



## Symbols glossary

 <p>Air cooling system: to ensure a safe surface temperatures.</p>	 <p>Defrost by time: with this function the time of thawing of foods are determined automatically.</p>
 <p>Triple glazed doors: Number of glazed doors.</p>	 <p>Electric</p>
 <p>Enamel interior: The enamel interior of all Smeg ovens have a special antacid lining which helps keep the interior clean by reducing the amount of cooking grease adhering to it.</p>	 <p>Fingerprint proof stainless steel: Fingerprint proof stainless steel keeps stainless steel looking as good as new.</p>
 <p>Fan with upper and lower elements: The elements combined with the fan aim to provide more uniform heat, a similar method to conventional cooking, so pre-heat is required. Most suitable for items requiring slow cooking methods.</p>	 <p>Upper and lower element only: a traditional cooking method best suited for single items located in the centre of the oven. the top pf the oven will always be hottest. Ideal for roast, fruit cakes, bread etc.</p>
 <p>Lower heating element only: This function is ideal for foods that require extra base temperature without browning, e.g. pastry dishes, pizza. Also suitable for slow cooking of stews and casseroles.</p>	 <p>Circulaire with lower element: The addition of the lower element adds extra heat at the base for food which requires extra cooking.</p>
 <p>Circulaire: The combination of the fan and circular element around it gives a hot air cooking method. This provides many benefits including no preheat if cook time is more than 20 minutes, no flavour transfer when cooking different foods at the same time, less energy, and shorter cook times. Good for all types of food.</p>	 <p>ECO: The combination of the grill, fan and lower element is particularly suitable for cooking small quantities of food.</p>
 <p>Grill element: Using of grill gives excellent results when cooking meat of medium and small portions, especially when combined with a rotisserie (where possible). Also ideal for cooking sausages and bacon.</p>	 <p>Fan with grill element: The fan reduces the fierce heat from the grill, providing an excellent method of grilling various foods, chops, steaks, sausages etc. giving even browning and heat distribution, without drying out the food. The top two levels recommended for use, and the lower part of the oven can be used to keep items warm at the same time, an excellent facility when cooking a grilled breakfast. Half grill (centre portion only) is ideal for small quantities of food.</p>
 <p>Pizza function: The simultaneous operation of three elements ensures an optimum cooking facility when used with the Smeg pizza stone.</p>	 <p>Circulaire with upper and lower elements: The use of the fan with both elements allows food to be cooked quickly and effectively, ideal for large joints that require thorough cooking. It offers a similar result to rotisserie, moving the heat around the food, instead of moving the food itself, enabling any size or shape to be cooked.</p>
 <p>All glass inner door: All glass inner door, a single flat surface which is simple to keep clean.</p>	 <p>The inner door glass: can be removed with a few quick movements for cleaning.</p>
 <p>KEEP_WARM_72dpi</p>	 <p>Side lights: Two opposing side lights increase visibility inside the oven.</p>

- 
- |  |   |
|--|---|
|  <p>Air at 40°C provides the perfect environment for proving yeast type dough mixes. Simply select the function and place dough in the cavity for allotted</p>   |  <p>Rapid preheat: The rapid preheat function can be used to reach the selected temperature in just a few minutes.</p> |
|  <p>Sabbath: This function allows you to cook food during the Sabbath, the Holiday of rest in the Jewish religion, respecting the precepts. The oven works</p>   |  <p>The oven cavity has 5 different cooking levels.</p>  |
|  <p>Electronic control: Allows you to maintain temperature inside the oven with the precision 2-3 ° C. This enables to cook meals that are very sensitive to temperature changes, such as cakes, souffles, puddings.</p> |  <p>Vapour Clean: a simple cleaning function using steam to loosen deposits in the oven cavity.</p>                    |
|  <p>The capacity indicates the amount of usable space in the oven cavity in litres.</p>  |  <p>...</p>  |