

SFA63M3TVX



Category	60cm
Product Family	Oven
Power supply	Electric
Heat source	ELECTRICITY
Cooking method	Thermoseal
Cleaning system	Vapour Clean
EAN code	8017709289317



Aesthetics









Aesthetic	Classic	Serigraphy type	Symbols and wordings
Colour	Stainless steel	Door	With 2 horizontal strips
Finishing	Fingerproof	Handle	Classic
Design	Flat	Handle Colour	Inox
Material	Stainless steel	Logo	Embossed
Type of steel	Brushed	Control knobs	Classic
Glass Type	Eclipse	Controls colour	Steel effect
Serigraphy colour	Black		

Controls

Control setting	Knobs	No. of controls	3
------------------------	-------	------------------------	---

Programs / Functions

No. of cooking functions	8
Traditional cooking functions	

 Static	 Fan assisted	 Circulaire
 Turbo	 Eco	 Large grill
 Fan grill (large)	 Base	

Other functions

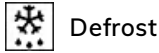

Defrost

Cleaning functions



Vapour Clean

Options

Time-setting options	Automatic end cooking	Timer	1
Minute minder	Yes		

Technical Features



Capacity (Lt)	72 l	Circular heating element - Power	2000 W
Minimum Temperature	60 °C	Heating suspended when door is opened	Yes
Maximum temperature	250 °C	Door opening type	Standard opening
No. of shelves	5	Door	Temperate door
N. of fans	1	Removable door	Yes
No. of lights	1	Full glass inner door	Yes
Light type	Halogen	Removable inner door	Yes
User-replaceable light	Yes	Total no. of door glasses	3
Light Power	40 W	Cooling system	Tangential
Light when door is opened	Yes	Cooling duct	Single
Lower heating element power	1200 W	Speed Reduction Cooling System	Yes
Upper heating element - Power	1000 W	Usable cavity space dimensions (HxWxD)	360x460x425 mm
Grill element - power	1700 W	Temperature control	Electro-mechanical
Large grill - Power	2700 W	Cavity material	Ever clean Enamel

Performance / Energy Label

Number of cavities	1
--------------------	---

Accessories Included

Rack with back and side stop	1	Enamelled deep tray (40mm)	1
Enamelled tray (20mm)	1	Insert grid	1

Electrical Connection

Voltage	220-240 V	Nominal power	3000 W
Plug	(I) Australia	Frequency (Hz)	50/60 Hz
Current	13 A	Power supply cable length	150 cm

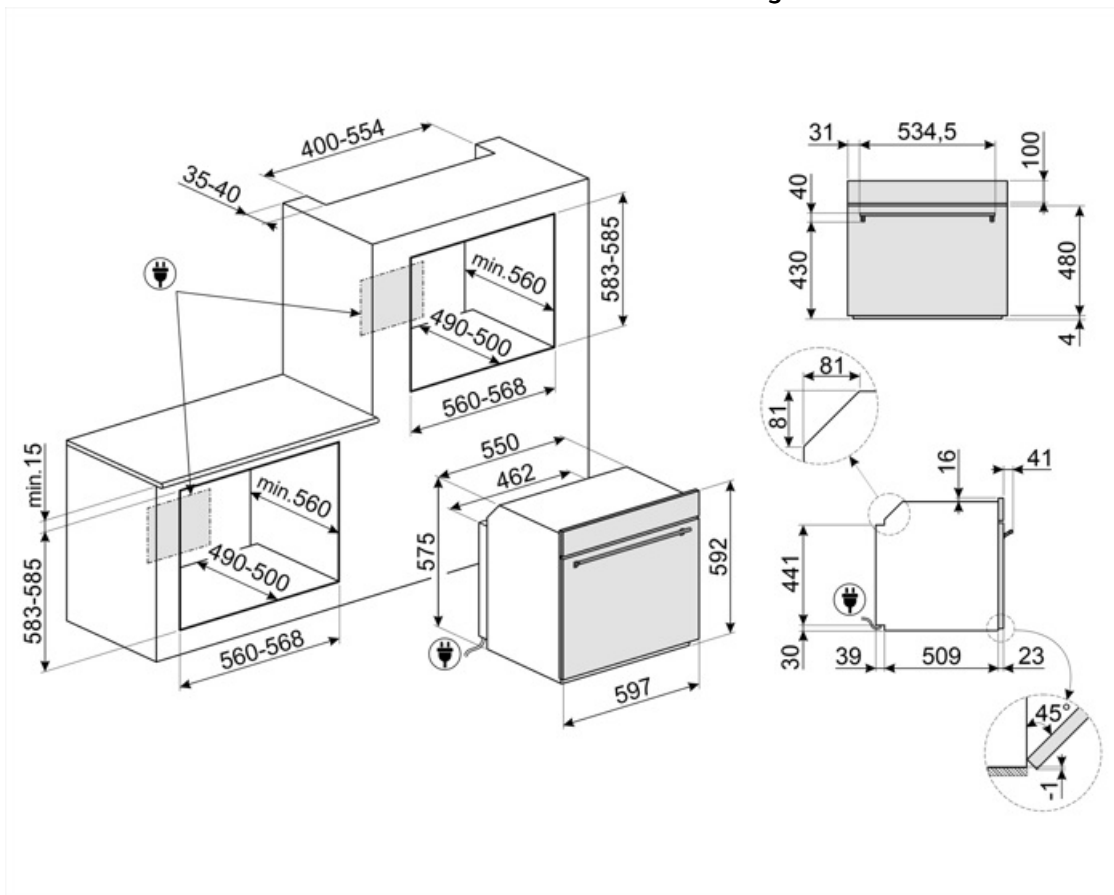

Compatible Accessories

BN620-1

Enamelled tray, 20mm deep



GTP

Partially extractable telescopic guides (1 level) Extraction: 300 mm Material: Stainless steel AISI 430 polished



PALPZ

Pizza shovel with fold away handle
width: 315mm length : 325mm



STONE2

Rectangular pizza stone without handles, suitable for 45cm and 60cm wide ovens. Dimensions W42 x H1.8 x D37.5cm. Ideal for cooking pizzas with the same results as a typical wood-fired oven. Can also be used for baking bread, focaccias and other recipes such as pies, flans or biscuits



BN640

Enamelled tray, 40mm deep



GTT

Totally extractable telescopic guides (1 level) Extraction: 433 mm Material: Stainless steel AISI 430 polished























PR3845X

Antifingerprint stainless steel. Cover for furniture in column installation of more ovens



Symbols glossary

 <p>Air cooling system: to ensure a safe surface temperatures.</p>	 <p>With the switch on this symbol, no heating is possible even if the thermostat is turned.</p>
 <p>Triple glazed doors: Number of glazed doors.</p>	 <p>Electric</p>
 <p>Enamel interior: The enamel interior of all Smeg ovens have a special antacid lining which helps keep the interior clean by reducing the amount of cooking grease adhering to it.</p>	 <p>Fingerprint proof stainless steel: Fingerprint proof stainless steel keeps stainless steel looking as good as new.</p>
 <p>Fan with upper and lower elements: The elements combined with the fan aim to provide more uniform heat, a similar method to conventional cooking, so pre-heat is required. Most suitable for items requiring slow cooking methods.</p>	 <p>Upper and lower element only: a traditional cooking method best suited for single items located in the centre of the oven. the top pf the oven will always be hottest. Ideal for roast, fruit cakes, bread etc.</p>
 <p>Lower heating element only: This function is ideal for foods that require extra base temperature without browning, e.g. pastry dishes, pizza. Also suitable for slow cooking of stews and casseroles.</p>	 <p>Circulaire: The combination of the fan and circular element around it gives a hot air cooking method. This provides many benefits including no preheat if cook time is more than 20 minutes, no flavour transfer when cooking different foods at the same time, less energy, and shorter cook times. Good for all types of food.</p>
 <p>ECO: The combination of the grill, fan and lower element is particularly suitable for cooking small quantities of food.</p>	 <p>Grill element: Using of grill gives excellent results when cooking meat of medium and small portions, especially when combined with a rotisserie (where possible). Also ideal for cooking sausages and bacon.</p>
 <p>Fan with grill element: The fan reduces the fierce heat from the grill, providing an excellent method of grilling various foods, chops, steaks, sausages etc. giving even browning and heat distribution, without drying out the food. The top two levels recommended for use, and the lower part of the oven can be used to keep items warm at the same time, an excellent facility when cooking a grilled breakfast. Half grill (centre portion only) is ideal for small quantities of food.</p>	 <p>Circulaire with upper and lower elements: The use of the fan with both elements allows food to be cooked quickly and effectively, ideal for large joints that require thorough cooking. It offers a similar result to rotisserie, moving the heat around the food, instead of moving the food itself, enabling any size or shape to be cooked.</p>
 <p>All glass inner door: All glass inner door, a single flat surface which is simple to keep clean.</p>	 <p>The inner door glass: can be removed with a few quick movements for cleaning.</p>
 <p>Side lights: Two opposing side lights increase visibility inside the oven.</p>	 <p>The oven cavity has 5 different cooking levels.</p>
 <p>Vapour Clean: a simple cleaning function using steam to loosen deposits in the oven cavity.</p>	 <p>The capacity indicates the amount of usable space in the oven cavity in litres.</p>