

SFPA6301TVX



Category	60cm
Product Family	Oven
Power supply	Electric
Heat source	ELECTRICITY
Cooking method	Thermoseal
Cleaning system	Pyrolitic
EAN code	8017709289324



Aesthetics

Aesthetic	Classic	Serigraphy colour	Black
Colour	Stainless steel	Serigraphy type	Symbols
Finishing	Fingerproof	Door	With 2 horizontal strips
Design	Flat	Handle	Classic
Material	Stainless steel	Handle Colour	Inox
Type of steel	Brushed	Logo	Embossed
Glass Type	Eclipse		

Controls

			
Display name	CompactScreen	No. of controls	2
Display technology	LCD	Control knobs	Classic
Control setting	Knobs	Controls colour	Steel effect

Programs / Functions

No. of cooking functions	10
--------------------------	----

Traditional cooking functions

 Static	 Fan assisted	 Circulaire
 Turbo	 Eco	 Large grill
 Fan grill (large)	 Base	 Circulaire + bottom
 Pizza		

Other functions

 Defrost by time	 Proving	 Sabbath
--	---	---

Cleaning functions

 Pirólisis
--

Options



Time-setting options	Delay start and automatic end cooking	Other options	Keep warm
Minute minder	Yes	Showroom demo option	Yes
Timer	1	Rapid pre-heating	Yes
Controls Lock / Child Safety	Yes		

Technical Features



Minimum Temperature	30 °C	Door opening type	Standard opening
Maximum temperature	280 °C	Door	Cool
No. of shelves	5	Removable door	Yes
Shelves type	Metal racks	Full glass inner door	Yes
N. of fans	1	Removable inner door	Yes
No. of lights	1	Total no. of door glasses	4
Light type	Halogen	Safety Thermostat	Yes
User-replaceable light	Yes	Cooling system	Tangential
Light Power	40 W	Cooling duct	Double
Light when door is opened	Yes	Speed Reduction Cooling System	Yes
Lower heating element power	1200 W	Door Lock During Pyrolysis	Yes
Grill element - power	1800 W	Usable cavity space dimensions (HxWxD)	360x444x425 mm
Circular heating element - Power	2000 W	Temperature control	Electronic

Heating suspended when door is opened

Yes

Cavity material

Ever clean Enamel

Performance / Energy Label



Energy efficiency class A+
 Net volume of the cavity 72 l
 Energy consumption per cycle in conventional mode 1.09 kWh
 Energy consumption in conventional mode 3.92 MJ

Energy consumption in forced air convection 2.45 MJ
 Energy consumption per cycle in fan-forced convection 0.68 kWh
 Number of cavities 1
 Energy efficiency index 80 %

Accessories Included

Insert grid 1
 Rack with back and side stop 1

Enamelled deep tray (40mm) 1

Electrical Connection

Plug (I) Australia
 Voltage 220-240 V
 Current 13 A

Nominal power 3000 W
 Frequency (Hz) 50/60 Hz
 Power supply cable length 115 cm

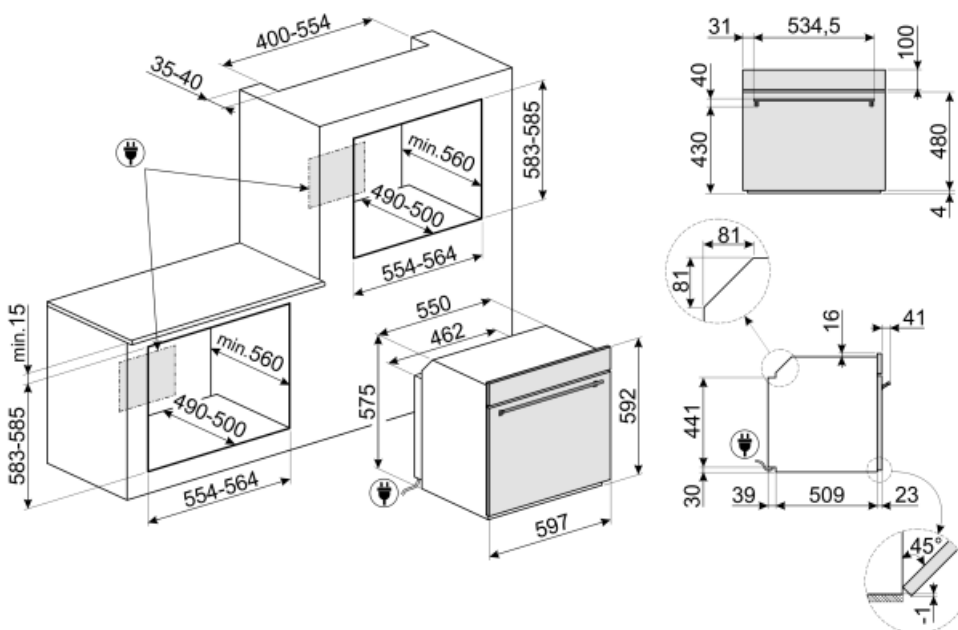

Not included accessories

GTP

Partially extractable telescopic guides (1 level) Extraction: 300 mm Material: Stainless steel AISI 430 polished



PRTX

Refractory pizza stone with handles. D=35cm Not suitable for microwave ovens. Suitable for gas ovens, to be put on the griddle.



PALPZ

Pizza shovel with fold away handle width: 315mm length : 325mm



BN640

Enamelled tray, 40mm deep



PR3845X

Antifingerprint stainless steel. Cover for furniture in column installation of more ovens



BN620-1

Enamelled tray, 20mm deep

































GTT

Totally extractable telescopic guides (1 level) Extraction: 433 mm Material: Stainless steel AISI 430 polished



Symbols glossary (TT)

-  A+: Energy efficiency class A+ helps to save up to 10% energy compared to class A. Maximum performance with minimum consumption is guaranteed.
-  Air cooling system: to ensure a safe surface temperatures.
-  Quadruple glazed: Number of glazed doors.
-  Enamel interior: The enamel interior of all Smeg ovens have a special antacid lining which helps keep the interior clean by reducing the amount of cooking grease adhering to it.
-  Fan with upper and lower elements: The elements combined with the fan aim to provide more uniform heat, a similar method to conventional cooking, so pre-heat is required. Most suitable for items requiring slow cooking methods.
-  Lower heating element only: This function is ideal for foods that require extra base temperature without browning, e.g. pastry dishes, pizza. Also suitable for slow cooking of stews and casseroles.
-  Circulaire: The combination of the fan and circular element around it gives a hot air cooking method. This provides many benefits including no preheat if cook time is more than 20 minutes, no flavour transfer when cooking different foods at the same time, less energy, and shorter cook times. Good for all types of food.
-  Grill element: Using of grill gives excellent results when cooking meat of medium and small portions, especially when combined with a rotisserie (where possible). Also ideal for cooking sausages and bacon.
-  Pizza function: The simultaneous operation of three elements ensures an optimum cooking facility when used with the Smeg pizza stone.
-  Child lock: some models are fitted with a device to lock the programme/cycle so it cannot be accidentally changed.
-  Defrost by time: with this function the time of thawing of foods are determined automatically.
-  Electric
-  Fresh Touch: Most of Smeg ovens have a "cool door." Thanks to the combination of tangential cooling and internal heat-reflecting glasses, the temperature on the outer surface of the door is maintained below 50° C. In addition to providing safety, this system protects the sides of the furniture from overheating by the oven.
-  Upper and lower element only: a traditional cooking method best suited for single items located in the centre of the oven. the top pf the oven will always be hottest. Ideal for roast, fruit cakes, bread etc.
-  Circulaire with lower element: The addition of the lower element adds extra heat at the base for food which requires extra cooking.
-  ECO: The combination of the grill, fan and lower element is particularly suitable for cooking small quantities of food.
-  Fan with grill element: The fan reduces the fierce heat from the grill, providing an excellent method of grilling various foods, chops, steaks, sausages etc. giving even browning and heat distribution, without drying out the food. The top two levels recommended for use, and the lower part of the oven can be used to keep items warm at the same time, an excellent facility when cooking a grilled breakfast. Half grill (centre portion only) is ideal for small quantities of food.
-  Circulaire with upper and lower elements: The use of the fan with both elements allows food to be cooked quickly and effectively, ideal for large joints that require thorough cooking. It offers a similar result to rotisserie, moving the heat around the food, instead of moving the food itself, enabling any size or shape to be cooked.

-
- | | | | |
|--|--|---|--|
|  | All glass inner door: All glass inner door, a single flat surface which is simple to keep clean. |  | The inner door glass: can be removed with a few quick movements for cleaning. |
|  | KEEP_WARM_72dpi |  | Side lights: Two opposing side lights increase visibility inside the oven. |
|  | Pyrolitic: Pyrolitic cleaning cycles can be selected as necessary to automatically clean the oven interior. |  | Air at 40°C provides the perfect environment for proving yeast type dough mixes. Simply select the function and place dough in the cavity for allotted |
|  | Rapid preheat: The rapid preheat function can be used to reach the selected temperature in just a few minutes. |  | Sabbath: This function allows you to cook food during the Sabbath, the Holiday of rest in the Jewish religion, respecting the precepts. The oven works |
|  | The oven cavity has 5 different cooking levels. |  | Electronic control: Allows you to maintain temperature inside the oven with the precision 2-3 ° C. This enables to cook meals that are very sensitive to temperature changes, such as cakes, souffles, puddings. |
|  | The capacity indicates the amount of usable space in the oven cavity in litres. |  | ... |