

# SFPR9604NR

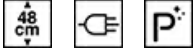

Category	Reduced height 90cm
Product Family	Oven
Power supply	Electric
Heat source	ELECTRICITY
Cooking method	Thermo-ventilated
Cleaning system	Pyrolytic
EAN code	8017709258221

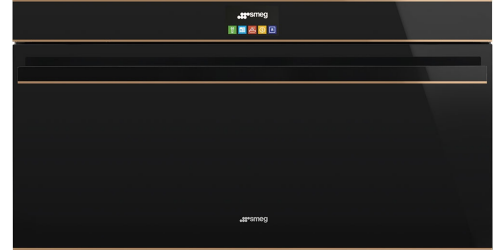

## Aesthetics

Aesthetic	Dolce Stil Novo	Glass Type	Eclipse
Colour	Black	Door	Full glass
Finishing	Glossy	Handle	Dolce Stil Novo
Design	Flat	Handle Colour	Black
Component finish	Copper	Logo	Applied
Material	Glass		











## Controls

	Display technology	TFT	No. of display languages	13
	Control setting	Full touch	Display languages	Italiano, English (UK), Français (FR), Nederlands, Español (ES), Português (PT), Svenska, Русский, Deutsch (DE), Dansk, Polski





## Programs / Functions

No. of cooking functions	10
Automatic programmes	50
Customisable recipes	10

## Traditional cooking functions

 Static	 Fan assisted	 Circulaire
 Turbo	 Eco	 Large grill
 Fan grill (large)	 Circulaire + grill	 Base
 Fan assisted base		

## Other functions

 Defrost by time	 Defrost by weight	 Leavening
 Sabbath		

## Cleaning functions

 Pirolisis	 Pirolisis eco
--	---

## Options



<b>Time-setting options</b>	Delay start and automatic end cooking	<b>Other options</b>	SmartCook system, Keep warm, Eco light, Language setting, Digital clock display, Tones
<b>Minute minder</b>	Yes	<b>Smart cooking</b>	Yes
<b>Controls Lock / Child Safety</b>	Yes	<b>Showroom demo option</b>	Yes

## Technical Features



<b>Minimum Temperature</b>	30 °C	<b>Heating suspended when door is opened</b>	Yes
<b>Maximum temperature</b>	280 °C	<b>Door opening type</b>	Standard opening
<b>No. of shelves</b>	4	<b>Door</b>	Cool
<b>Shelves type</b>	Metal racks	<b>Removable door</b>	Yes
<b>N. of fans</b>	3	<b>Full glass inner door</b>	Yes
<b>No. of lights</b>	2	<b>Removable inner door</b>	Yes
<b>Light type</b>	Halogen	<b>Total no. of door glasses</b>	4
<b>User-replaceable light</b>	Yes	<b>Soft Close hinges</b>	Yes
<b>Light Power</b>	40 W	<b>Safety Thermostat</b>	Yes
<b>Light when door is opened</b>	Yes	<b>Cooling system</b>	Tangential
<b>Lower heating element power</b>	1700 W	<b>Cooling duct</b>	Double
		<b>Speed Reduction Cooling System</b>	Yes

Upper heating element - 1200 W  
Power

Grill element - power 1700 W

Large grill - Power 2900 W

Circular heating element 1550 W  
- Power

Circular heating element 1550 W  
2 - Power

Usable cavity space dimensions (HxWxD) 283x724x418 mm

Temperature control Electronic

Cavity material Ever clean Enamel

## Performance / Energy Label



Energy efficiency class A+

Net volume of the cavity 85 l

Energy consumption per cycle in conventional mode 0.74 kWh

Energy consumption in conventional mode 2.66 MJ

Energy consumption in forced air convection 4.64 MJ

Energy consumption per cycle in fan-forced convection 1.29 kWh

Number of cavities 1

Energy efficiency index 81.3 %

## Accessories Included



Rack with back stop 1

Insert gird 1

Telescopic Guide rails, total Extraction 1

Enamelled deep tray (40mm) 1

## Electrical Connection

Voltage 220-240 V

Current 15 A

Nominal power 3300 W

Frequency (Hz) 50/60 Hz

Power supply cable length 115 cm

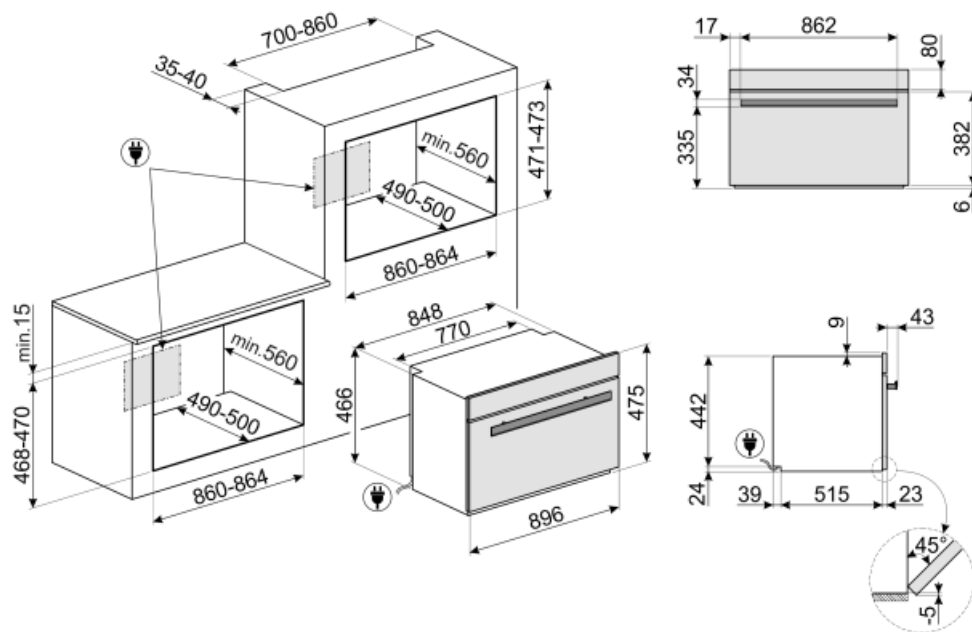

---

## Not included accessories

---

### GTP

Partially extractable telescopic guides (1 level), suitable for traditional ovens. Made in stainless steel, they guarantee stability and facilitate the smooth extraction of the trays.



### PPR9

Refractory pizza stone without handles. Squared shaped stone: L64xH2,3xP37,5 cm Suitable also for gas ovens, to be put on the griddle.



### BNP608T

Teflon-coated tray, 8mm depth, to be placed on the grid



































### GTT

Totally extractable telescopic guides (1 level), suitable for traditional ovens. Made in stainless steel, they guarantee stability and facilitate the smooth extraction of the trays.



## Symbols glossary (TT)

 <p>Triple Fan Technology: The oven is equipped with an exclusive three fan system, which, combined with the increased power of the motors, enables excellent cooking performance. The two large side fans distribute the air around the outer perimeter of the cavity while the smaller central fan increases ventilation by creating a vertical vortex of heat. Accordingly, the temperature within the cavity is uniform, allowing food to be cooked evenly on all five levels, like in professional kitchens.</p>	 <p>A+: Energy efficiency class A+ helps to save up to 10% energy compared to class A. Maximum performance with minimum consumption is guaranteed.</p>
 <p>Child lock: some models are fitted with a device to lock the programme/cycle so it cannot be accidentally changed.</p>	 <p>Air cooling system: to ensure a safe surface temperatures.</p>
 <p>Defrost by time: Manual defrost function. At the end of the set duration, the function stops.</p>	 <p>Defrost by weight: Automatic defrost function. You choose the type of food to defrost from the available categories (MEAT - FISH - BREAD - DESSERTS) After entering the weight of the food, the oven automatically defines the time required for proper defrosting.</p>
 <p>Quadruple glazed: Number of glazed doors.</p>	 <p>EASYGUIDE_72dpi</p>
 <p>Automatic lighting deactivation: For greater energy savings, the lighting turns off automatically after one minute from the start of cooking The option can be disabled via the settings menu. In this case the light will remain on for the entire duration of cooking.</p>	 <p>Electric</p>
 <p>Ever Clean Enamel: Ever Clean enamel is applied electrostatically, corner to corner and edge to edge to prevent cracking or cracks over time. It is a particular pyrolytic enamel, resistant to acids which, in addition to being pleasantly bright, promotes greater cleaning of the oven walls, thanks to its lower porosity. It is baked at over 850 ° C and slowly polymerized at a scientifically determined rate to ensure uniform depth and strength Ever Clean enamel creates an impeccable finish both on the inside of the oven and on the trays, making the surfaces of the oven incredibly easy to maintain over time as it reduces the adhesion of fat during cooking</p>	 <p>Fresh Touch: Most of Smeg ovens have a "cool door." Thanks to the combination of tangential cooling and internal heat-reflecting glasses, the temperature on the outer surface of the door is maintained below 50° C. In addition to providing safety, this system protects the sides of the furniture from overheating by the oven.</p>
 <p>Fan assisted base: the mix of fan and lower heating element alone allows to finish cooking foods already cooked on the surface but not internally more quickly. This system is recommended to finish cooking foods that are already well cooked on the surface, but not internally, which therefore require a moderate higher heat. Ideal for any type of food.</p>	 <p>Fan assisted: Intense and homogeneous traditional cooking, also suitable for complex recipes. The fan is active and the heat comes from below and from above at the same time. Ventilated cooking ensures a faster and more homogeneous result, leaving fragrant foods outside and moister inside. Ideal for baked pasta, biscuits, roasts and cobblers.</p>

- |   |   |
|---|---|
|  <p><b>Static:</b> Traditional cooking suitable for the preparation of one dish at a time. The fan is not active and the heat comes from below and from above at the same time. Static cooking is slower and more delicate, ideal in order to get well cooked and dry dishes even inside. Ideal for cooking all types of roasts, fatty meats, bread, filled cakes.</p>  |  <p><b>Base:</b> the heat comes only from the bottom of the cavity. The fan is not active. Ideal for sweet and savory pies, cobblers and pizzas. Designed to complete cooking and make food more crunchy. This symbol in gas ovens indicates the gas burner.</p>   |
|  <p><b>Circulaire + grill:</b> Circulaire with upper element or grill: Similar to fan with upper element with the added cooking speed of circulaire, ideal for dishes with a crispy topping. When used with the grill the food will brown more quickly.</p>   |  <p><b>Circulaire:</b> it is the perfect function for cooking all types of dishes in a more delicate way. The heat comes from the back of the oven and is distributed quickly and evenly. The fan is active. It is also ideal for cooking on multiple levels without mixing smells and flavors.</p>  |
|  <p><b>ECO:</b> low energy consumption cooking: this function is particularly suitable for cooking on a single shelf with low energy consumption. It is recommended for all types of food except those that can generate a lot of moisture (for example vegetables). To achieve maximum energy savings and reduce time, it is recommended to put the food in the oven without preheating the cooking compartment.</p> |  <p><b>Grill:</b> Very intense heat coming only from above from a double heating element. The fan is not active. Provides excellent grilling and gratinating results. Used at the end of cooking, it gives a uniform browning to dishes.</p>   |
|  <p><b>Fan grill:</b> very intense heat coming only from above from a double heating element. The fan is active. It allows the optimal grilling of thickest meats. Ideal for large cuts of meat.</p>  |  <p><b>Turbo:</b> the heat comes from 3 directions: above, below and from the back of the oven. The fan is active. It allows quick cooking, even on several shelves without mixing the aromas. Ideal for large volumes or foods that require intense cooking.</p>  |
|  <p><b>Compact appliances with a height of 48 cm.</b> Perfect solution to meet the functional requirements of kitchen sets of small height. Available in several types and in different styles.</p>   |  <p><b>All glass inner door:</b> All glass inner door, a single flat surface which is simple to keep clean.</p>  |
|  <p><b>The inner door glass:</b> can be removed with a few quick movements for cleaning.</p>  |  <p><b>KEEP_WARM_72dpi</b></p>   |
|  <p><b>Side lights:</b> Two opposing side lights increase visibility inside the oven.</p>   |  <p><b>PYROLYSIS - AUTOMATIC CLEANING FUNCTION:</b> the oven heats up to a temperature approaching 500 ° C and chars grease and food residues into a fine ash that can be easily wiped off with a damp cloth. At such a high temperature, the door locks automatically for safety, while the temperature of the door remains controlled so it is safe to touch. User adjustable function based on the level of dirt present in the oven.</p> |
|  <p><b>Pyrolytic:</b> The Eco pyrolytic cleaning function can be selected when the oven has a lighter build up of dirt. This function has a maximum duration of 1.5 hours.</p>  |  <p><b>Air at 40°C</b> provides the perfect environment for proving yeast type dough mixes. Simply select the function and place dough in the cavity for allotted.</p>   |
|  <p><b>SABBATH:</b> function that allows to cook food respecting Judaism's day of rest provisions.</p>  |  <p>The oven cavity has 4 different cooking levels.</p>  |



Smart Cooking is the perfect recipe for every occasion. Meat, fish, pasta, desserts, etc . up to 150 automatic recipes that allow to make any preparation in a single click. Decide your menu and then the oven takes care of the rest.



Telescopic rails: allow you to pull out the dish and check it without having to remove it from the oven entirely.



Touch controls: Easy to use touch controls allow the appliance to be programmed at the touch of a button.



Soft close: all models are equipped with advanced function of smooth closing of the door, which allows the device to close smoothly and quietly.



Electronic control: Allows you to maintain temperature inside the oven with the precision 2-3 ° C. This enables to cook meals that are very sensitive to temperature changes, such as cakes, souffles, puddings.



The capacity indicates the amount of usable space in the oven cavity in litres.