

# SFU4300MX

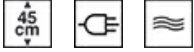

|                       |                      |
|-----------------------|----------------------|
| <b>Category</b>       | Compact 24"          |
| <b>Product family</b> | Oven                 |
| <b>Power supply</b>   | Electrical           |
| <b>Cooking method</b> | Microwave with grill |
| <b>EAN code</b>       | 8017709310295        |



## Aesthetic

|                             |                   |                         |                 |
|-----------------------------|-------------------|-------------------------|-----------------|
| <b>Aesthetics</b>           | Classic           | <b>Silkscreen color</b> | Black           |
| <b>Color</b>                | Stainless steel   | <b>Silkscreen type</b>  | Symbols         |
| <b>Finishing</b>            | Fingerprint-proof | <b>Handle</b>           | Classic         |
| <b>Design</b>               | Flat              | <b>Handle color</b>     | Stainless steel |
| <b>Material</b>             | Stainless steel   | <b>Logo</b>             | Embossed        |
| <b>Stainless steel type</b> | Brushed           |                         |                 |

## Controls

|  |            |                         |               |
|--|------------|-------------------------|---------------|
|  |            |                         |               |
| <b>Display name</b>  | DigiScreen | <b>Controls setting</b> | Control knobs |
| <b>Display technology</b>  | LED        | <b>No. of controls</b>  | 2             |

## Programs / Functions

**No. of cooking functions** 3

**Traditional cooking functions**



Broil

**Microwave functions**



Microwave



Microwave + Grill

## Options

|                             |                                   |              |   |
|-----------------------------|-----------------------------------|--------------|---|
| <b>Time-setting options</b> | End-of-cooking automatic shut-off | <b>Timer</b> | 1 |
| <b>Minute minder</b>        | Yes                               |              |   |

## Technical Features



|                                   |          |  |                 |
|-----------------------------------|----------|--|-----------------|
| <b>Capacity (Lt)</b>              | 38 l     | <b>Grill element - power</b>               | 1200 W          |
| <b>No. of shelf positions</b>     | 2        | <b>Total no. of door glasses</b>           | 3               |
| <b>No. of lights</b>              | 1        | <b>Microwave stops when door is opened</b> | Yes             |
| <b>Light power</b>                | 20 W     | <b>Cooling duct</b>                        | Single          |
| <b>Light on when door is open</b> | Yes      | <b>Cavity material</b>                     | Stainless steel |
| <b>Turntable</b>                  | Yes      | <b>Microwave screen protection</b>         | Yes             |
| <b>Turntable dimension</b>        | 12 5/8 " |  |                 |

## Performance / Energy Label

|                             |              |                                  |        |
|-----------------------------|--------------|----------------------------------|--------|
| <b>Volume of the cavity</b> | 1.34 cu. ft. | <b>Microwave effective power</b> | 1000 W |
| <b>Number of cavities</b>   | 1            |                                  |        |

## Accessories Included

|             |   |
|-------------|---|
| <b>Rack</b> | 2 |
|-------------|---|

## Electrical Connection

|                |        |                          |           |
|----------------|--------|--------------------------|-----------|
| <b>Voltage</b> | 240 V  | <b>Nominal power</b>     | 3400 W    |
| <b>Plug</b>    | No     | <b>Frequency</b>         | 60 Hz     |
| <b>Current</b> | 14,2 A | <b>Power cord length</b> | 59 1/16 " |

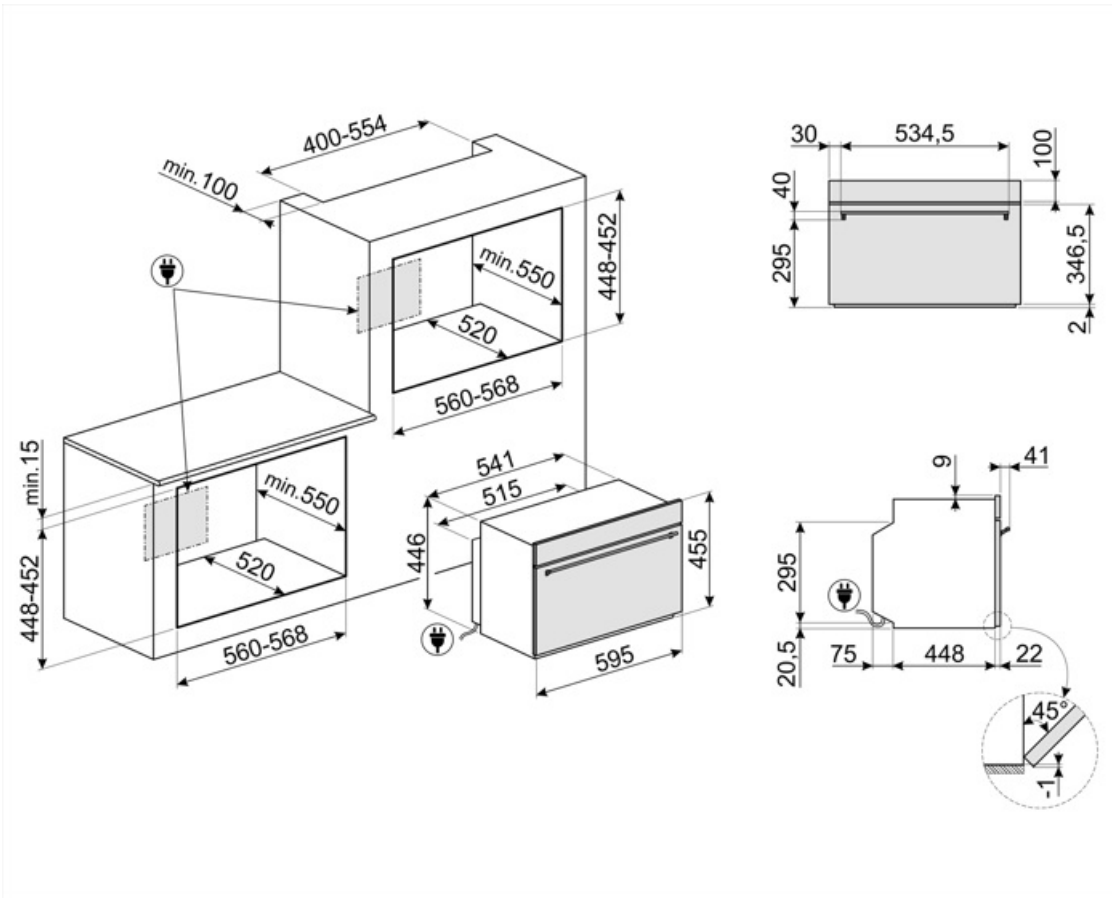

---

## Compatible Accessories

---

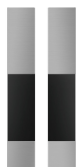











KIT4300MX



### STONE2

Rectangular pizza stone without handles, suitable for 45cm and 60cm wide ovens. Dimensions W42 x H1.8 x D37.5cm. Ideal for cooking pizzas with the same results as a typical wood-fired oven. Can also be used for baking bread, focaccias and other recipes such as pies, flans or biscuits

## Symbols glossary

|  |  |  |   |
|--|--|--|---|
|    | Microwave energy shortens cooking times dramatically and produces energy savings.  |   | 4.3 inch display with LED technology, usability with knobs + 3 touch keys   |
|    | Triple glazed doors: Number of glazed doors.   |   | Electric  |
|    | Enamel interior: The enamel interior of all Smeg ovens have a special antacid lining which helps keep the interior clean by reducing the amount of cooking grease adhering to it.  |   | Grill element: Using of grill gives excellent results when cooking meat of medium and small portions, especially when combined with a rotisserie (where possible). Also ideal for cooking sausages and bacon. |
|    | Microwave: Penetrating straight into the food, microwaves cook very quickly and with considerable energy savings. Suitable for cooking without fat, they are also able to thaw and heat food without altering its original appearance and aroma. The microwave function can also be combined with conventional functions with all the resulting advantages. Ideal for all types of food. |   | Microwave + grill element: The use of the grill results in a perfect browning of the surface of the food. The action of microwaves allows instead of cooking in a short time the internal part of the food.   |
|   | Compact appliances with a height of 45 cm - perfect solution to meet the functional requirements of kitchen sets of small height. Available in several types and in different styles.  |  | The oven cavity has 2 different cooking levels.   |
|  | The capacity indicates the amount of usable space in the oven cavity in litres.  |  |   |