

SFU4302VCX

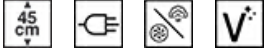

Category	45 cm
Product Family	Oven
Power supply	Electric
Heat source	ELECTRICITY
Cooking method	Combi Steam
Cleaning system	Vapor Clean
EAN code	8017709252076



Aesthetics

Aesthetic	Classica	Serigraphy type	Symbols
Colour	Stainless steel	Door	With 2 horizontal strips
Finishing	Fingerproof	Handle	Classic
Design	Flat	Handle Colour	Inox
Material	Stainless steel	Logo	Embossed
Type of steel	Brushed	Control knobs	Classic
Glass Type	Eclipse	Controls colour	Steel effect
Serigraphy colour	Black		

Controls

Display technology	LCD	No. of controls	2
Control setting	Knobs		

Programs / Functions

No. of cooking functions	14
Automatic programmes	20

Traditional cooking functions

- | | | |
|-------------------|--------------|-------------------|
| Static | Fan assisted | Circulaire |
| Turbo | Eco | Large grill |
| Fan grill (large) | Base | Fan assisted base |

Cooking functions with steam

- | | | |
|---------------------------|--------------|------------|
| Steam | Fan assisted | Circulaire |
| Warming and re-generation | | |

Other Steam functions

- | | | |
|---------------------|--------------|-------------|
| Tank cleaning | Water outlet | Water input |
| Descaling programme | | |

Other functions

- | | | |
|-----------------|-------------------|-----------|
| Defrost by time | Defrost by weight | Leavening |
| Sabbath | | |

Cleaning functions

- Vapor Clean

Options



- | | |
|-------------------------------------|---------------------------------------|
| Time-setting options | Delay start and automatic end cooking |
| Minute minder | Yes |
| Controls Lock / Child Safety | Yes |

- | | |
|-----------------------------|----------------------|
| Other options | Keep warm, Eco light |
| Showroom demo option | Yes |

Technical Features



- | | | | |
|----------------------------|---------|----------------------------------|----------------|
| Minimum Temperature | 86 °F | Door | Temperate door |
| Maximum temperature | 482 °F | Removable door | Yes |
| No. of shelves | 3 | Full glass inner door | Yes |
| No. of lights | 1 | Removable inner door | Yes |
| Light type | Halogen | Total no. of door glasses | 3 |

User-replaceable light	Yes	Soft Close hinges	Yes
Light Power	40 W	Cooling system	Tangential
Light when door is opened	Yes	Cooling duct	Single
Lower heating element power	1000 W	Temperature control	Electronic
Grill element - power	2000 W	Cavity material	Ever clean Enamel
Circular heating element - Power	1400 W	Water loading	Fill&Hide, automatic
Heating suspended when door is opened	Yes	Tank capacity	1,2 l
Boiler - Power	1000 W	Steam stops when door is opened	Yes
Door opening type	Standard opening		

Performance / Energy Label



Net volume of the cavity 1.41 cu. ft.

Accessories Included



Rack with back stop	1	St/steel perforated deep tray (40mm)	1
Enamelled deep tray (40mm)	1	Telescopic Guide rails, total Extraction (inox)	1
Insert gird	1	Other	Sponge/ Boiler cover/ Beaker
St/steel tray (20mm)	1		

Electrical Connection

Voltage	230 V	Current 2	13 A
Nominal power	3400 W	Frequency (Hz)	60 Hz
Voltage 2	120/208 V	Power supply cable length	45 1/4 "

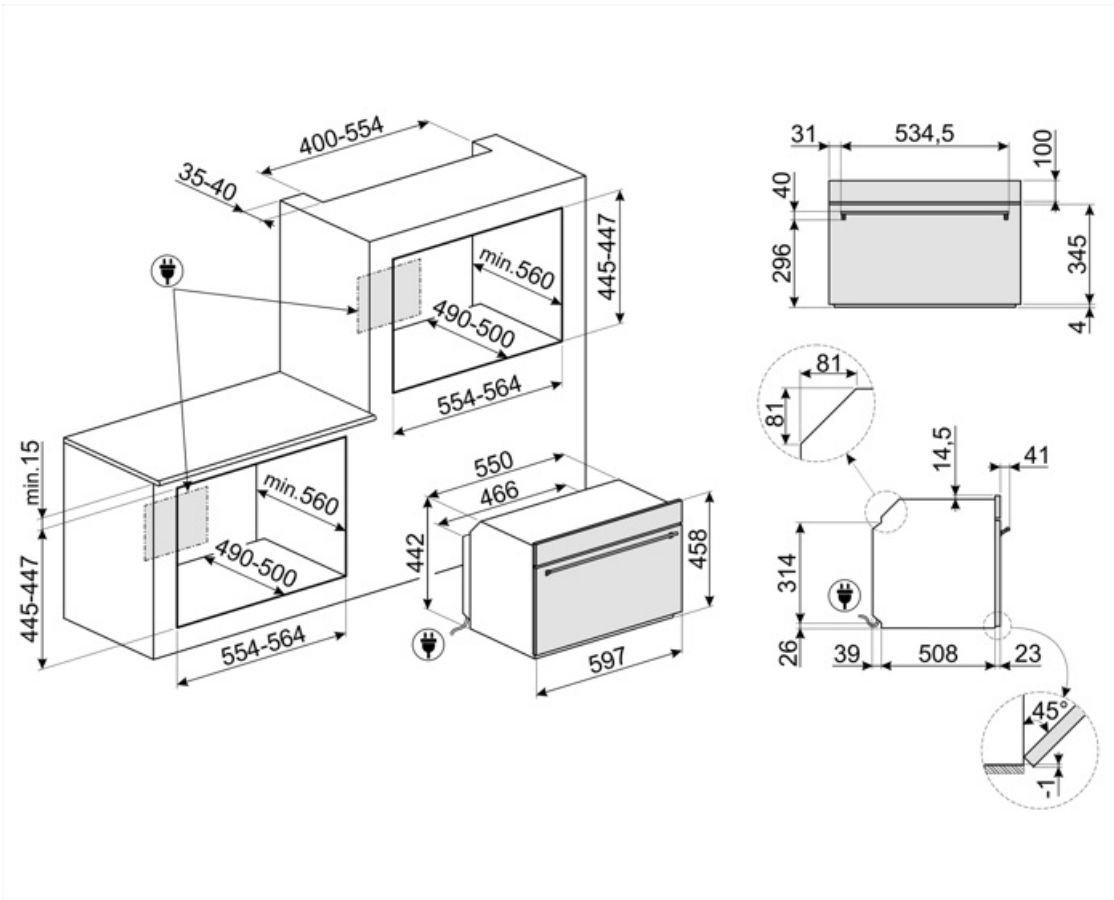

Not included accessories

GTP

Partially extractable telescopic guides (1 level), suitable for traditional ovens. Made in stainless steel, they guarantee stability and facilitate the smooth extraction of the trays.



PRTX

Refractory pizza stone with handles. D=35cm Not suitable for microwave ovens. Suitable for gas ovens, to be put on the griddle.



KIT370X



BN640

Enamelled tray suitable for 45cm and 60cm ovens. Depth 540 mm. Perfect for cooking and roasting meat and fish in sauces. Also ideal for experimenting with lighter and crunchy side dishes



PR3845X

Antifingerprint stainless steel. Cover for furniture in column installation of more ovens



BN620-1

Enamelled tray suitable for 45cm and 60cm ovens. Depth 20 mm. Perfect for a wide range of savoury and sweet baking.



PALPZ

Pizza shovel with folding handle. Dimensions L31.5 x H32.5 cm. Easy and convenient to use and store. Perfect for serving pizza, bread and savory pastries in a safe and professional way.

























KIT330X

















Trim kit for 45 cm Classica ovens



Symbols glossary (TT)

-  Child lock: some models are fitted with a device to lock the programme/cycle so it cannot be accidentally changed.
-  Combi steam ovens: The steam cooking system allows to cook any type of food more gently and quickly. Variations in temperature and steam level allow you to achieve the desired gastronomic result. Steam cooking decrease the use of fat in favor of a healthier and more genuine cuisine, and also minimizes the loss of weight and volume of food during cooking. Steam cooking is perfect for cooking meats: in addition to making them very soft, it maintains their shine and makes them more succulent. Also recommended for cooking leavened doughs and bread-making: humidity in fact allows the dough to grow and develop during cooking before creating the external crust. The result is a lighter and more digestible dough, recognizable by the larger alveolation. It is also suitable for defrosting quickly, for heating foods without hardening or drying them and for naturally desalting salted foods.
-  Air cooling system: to ensure a safe surface temperatures.
-  Defrost by weight: Automatic defrost function. You choose the type of food to defrost from the available categories (MEAT - FISH - BREAD - DESSERTS) After entering the weight of the food, the oven automatically defines the time required for proper defrosting.
-  Triple glazed doors: Number of glazed doors.
-  Electric
-  Defrost by time: Manual defrost function. At the end of the set duration, the function stops.
-  Descaling function: Is essential to remove excess deposits of limestone in the tank and allow the proper operation of the product. The need to perform this operation is signaled by the product itself.
-  Automatic lighting deactivation: For greater energy savings, the lighting turns off automatically after one minute from the start of cooking The option can be disabled via the settings menu. In this case the light will remain on for the entire duration of cooking.
-  Ever Clean Enamel: Ever Clean enamel is applied electrostatically, corner to corner and edge to edge to prevent cracking or cracks over time. It is a particular pyrolytic enamel, resistant to acids which, in addition to being pleasantly bright, promotes greater cleaning of the oven walls, thanks to its lower porosity. It is baked at over 850 ° C and slowly polymerized at a scientifically determined rate to ensure uniform depth and strength Ever Clean enamel creates an impeccable finish both on the inside of the oven and on the trays, making the surfaces of the oven incredibly easy to maintain over time as it reduces the adhesion of fat during cooking

-  Fan assisted base: the mix of fan and lower heating element alone allows to finish cooking foods already cooked on the surface but not internally more quickly. This system is recommended to finish cooking foods that are already well cooked on the surface, but not internally, which therefore require a moderate higher heat. Ideal for any type of food.
-  Static: Traditional cooking suitable for the preparation of one dish at a time. The fan is not active and the heat comes from below and from above at the same time. Static cooking is slower and more delicate, ideal in order to get well cooked and dry dishes even inside. Ideal for cooking all types of roasts, fatty meats, bread, filled cakes.
-  Circulaire: it is the perfect function for cooking all types of dishes in a more delicate way. The heat comes from the back of the oven and is distributed quickly and evenly. The fan is active. It is also ideal for cooking on multiple levels without mixing smells and flavors.
-  Grill: Very intense heat coming only from above from a double heating element. The fan is not active. Provides excellent grilling and gratinating results. Used at the end of cooking, it gives a uniform browning to dishes.
-  Steam cooking: it's a natural way of cooking for any kind of products, from vegetables to desserts, to preserve the nutritional and organoleptic properties of ingredients. Ideal for cooking without fat, to heat up food without drying. Steam is ideal for simultaneous cooking of meals that require different cooking times.
-  Circulaire + Steam: The addition of steam to thermoventilated cooking allows better preservation of the organoleptic properties of food. The heat comes from the back of the oven and is distributed quickly and evenly. The fan is active. It is the perfect function for cooking all types of dishes in a more delicate way. It is also ideal for cooking on multiple levels without mixing smells and flavors. Ideal for preparing roasts, chicken and baked goods such as leavened cakes and bread.
-  Fan assisted: Intense and homogeneous traditional cooking, also suitable for complex recipes. The fan is active and the heat comes from below and from above at the same time. Ventilated cooking ensures a faster and more homogeneous result, leaving fragrant foods outside and moister inside. Ideal for baked pasta, biscuits, roasts and cobblers.
-  Base: the heat comes only from the bottom of the cavity. The fan is not active. Ideal for sweet and savory pies, cobblers and pizzas. Designed to complete cooking and make food more crunchy. This symbol in gas ovens indicates the gas burner.
-  ECO: low energy consumption cooking: this function is particularly suitable for cooking on a single shelf with low energy consumption. It is recommended for all types of food except those that can generate a lot of moisture (for example vegetables). To achieve maximum energy savings and reduce time, it is recommended to put the food in the oven without preheating the cooking compartment.
-  Fan grill: very intense heat coming only from above from a double heating element. The fan is active. It allows the optimal grilling of thickest meats. Ideal for large cuts of meat.
-  Fun assisted + Steam: intense and homogeneous cooking. The fan is active and the heat comes from below and from above at the same time. The addition of steam allows better preservation of the organoleptic properties of food and improves the internal cooking of foods, which are more crunchy and digestible. Ideal for roast veal, roast duck and for cooking whole fish.
-  FUN_STEAM_OTHER_WATER_IN_OUT_72dpi

-  **Reheat:** This function can reheat precooked dishes, without becoming dry or hard.
-  **Compact appliances with a height of 45 cm -** perfect solution to meet the functional requirements of kitchen sets of small height. Available in several types and in different styles.
-  **The inner door glass:** can be removed with a few quick movements for cleaning.
-  **Side lights:** Two opposing side lights increase visibility inside the oven.
-  **Air at 40°C** provides the perfect environment for proving yeast type dough mixes. Simply select the function and place dough in the cavity for allotted
-  **The oven cavity has 3 different cooking levels.**
-  **To guarantee the optimal functioning of the appliance,** it is suggested to carry out the tank cleaning roughly once every 2-3 months.
-  **Electronic control:** Allows you to maintain temperature inside the oven with the precision 2-3 ° C. This enables to cook meals that are very sensitive to temperature changes, such as cakes, souffles, puddings.
-  **The capacity indicates the amount of usable space in the oven cavity in litres.**
-  **Turbo:** the heat comes from 3 directions: above, below and from the back of the oven The fan is active. It allows quick cooking, even on several shelves without mixing the aromas. Ideal for large volumes or foods that require intense cooking.
-  **All glass inner door:** All glass inner door, a single flat surface which is simple to keep clean.
-  **KEEP_WARM_72dpi**
-  **ECO-logic:** option allows you to restrict the power limit of the appliance real energy saving.
-  **SABBATH:** function that allows to cook food respecting Judaism's day of rest provisions.
-  **Soft close:** all models are equipped with advanced function of smooth closing of the door, which allows the device to close smoothly and quietly.
-  **Telescopic rails:** allow you to pull out the dish and check it without having to remove it from the oven entirely.
-  **Vapor Clean:** a simple cleaning function using steam to loosen deposits in the oven cavity.