

SFU6302TVX



Category	60cm
Product Family	Oven
Power supply	Electric
Cooking method	Thermo-ventilated
Cleaning system	Vapor Clean



Aesthetics









Aesthetic	Classica	Type of steel	Brushed
Colour	Stainless steel	Serigraphy colour	Black
Finishing	Fingerproof	Serigraphy type	Symbols
Design	Flat	Handle Colour	Inox
Material	Stainless steel	Logo	Embossed

Controls

Display technology	LCD
--------------------	-----

Programs / Functions

No. of cooking functions	9
Automatic programmes	20
Traditional cooking functions	

 Static	 Fan assisted	 Circulaire
 Turbo	 ECO Eco	 Large grill
 Fan grill (large)	 Base	 Fan assisted base

Other functions

Defrost by time

Defrost by weight

Leavening

Sabbath

Cleaning functions

Vapor Clean

Options



Time-setting options Delay start and automatic end cooking

Minute minder Yes

Controls Lock / Child Safety Yes

Other options Keep warm, Eco light

Showroom demo option Yes

Technical Features



Minimum Temperature 86 °F

Maximum temperature 536 °F

No. of shelves 5

N. of fans 1

No. of lights 2

Light type Halogen

User-replaceable light Yes

Light Power 40 W

Light when door is opened Yes

Lower heating element power 1200 W

Upper heating element - Power 1000 W

Grill element - power 1700 W

Large grill - Power 2700 W

Circular heating element - Power 2000 W

Heating suspended when door is opened Yes

Door Cool

Removable inner door Yes

Total no. of door glasses 4

Soft Close hinges Yes

Cooling system Tangential

Cooling duct Single

Speed Reduction Cooling System Yes

Cavity material Ever clean Enamel

Performance / Energy Label



Net volume of the cavity 2.54 cu. ft.

Accessories Included



Insert grid

1

Rack with back and side stop 1

Enamelled tray (20mm) 1

Enamelled deep tray (40mm)

Telescopic Guide rails, partial Extraction 1

Electrical Connection

Voltage 230 V
 Nominal power 3400 W
 Voltage 2 120/208 V

Current 2 13 A
 Frequency (Hz) 60 Hz
 Power supply cable length 45 1/4 "

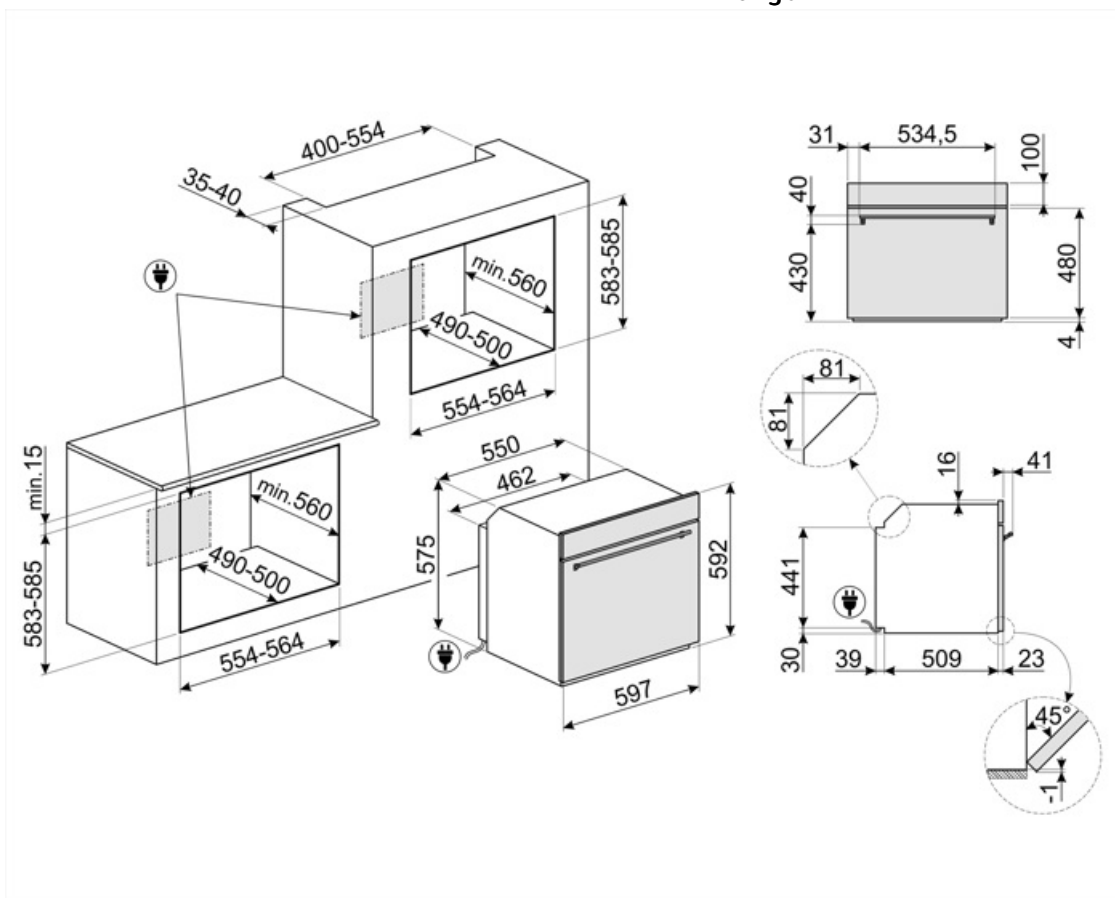

Not included accessories

GTP

Partially extractable telescopic guides (1 level), suitable for traditional ovens. Made in stainless steel, they guarantee stability and facilitate the smooth extraction of the trays.



PRTX

Refractory pizza stone with handles. D=35cm Not suitable for microwave ovens. Suitable for gas ovens, to be put on the griddle.



PALPZ

Pizza shovel with folding handle. Dimensions L31.5 x H32.5 cm. Easy and convenient to use and store. Perfect for serving pizza, bread and savory pastries in a safe and professional way.



BN640

Enamelled tray suitable for 45cm and 60cm ovens. Depth 540 mm. Perfect for cooking and roasting meat and fish in sauces. Also ideal for experimenting with lighter and crunchy side dishes



PR3845X

Antifingerprint stainless steel. Cover for furniture in column installation of more ovens



BN620-1

Enamelled tray suitable for 45cm and 60cm ovens. Depth 20 mm. Perfect for a wide range of savoury and sweet baking.































GTT

Totally extractable telescopic guides (1 level), suitable for traditional ovens. Made in stainless steel, they guarantee stability and facilitate the smooth extraction of the trays.



Symbols glossary (TT)

 <p>Child lock: some models are fitted with a device to lock the programme/cycle so it cannot be accidentally changed.</p>	 <p>Air cooling system: to ensure a safe surface temperatures.</p>
 <p>Defrost by time: Manual defrost function. At the end of the set duration, the function stops.</p>	 <p>Defrost by weight: Automatic defrost function. You choose the type of food to defrost from the available categories (MEAT - FISH - BREAD - DESSERTS) After entering the weight of the food, the oven automatically defines the time required for proper defrosting.</p>
 <p>Quadruple glazed: Number of glazed doors.</p>	 <p>Automatic lighting deactivation: For greater energy savings, the lighting turns off automatically after one minute from the start of cooking The option can be disabled via the settings menu. In this case the light will remain on for the entire duration of cooking.</p>
 <p>Electric</p>	 <p>Ever Clean Enamel: Ever Clean enamel is applied electrostatically, corner to corner and edge to edge to prevent cracking or cracks over time. It is a particular pyrolytic enamel, resistant to acids which, in addition to being pleasantly bright, promotes greater cleaning of the oven walls, thanks to its lower porosity. It is baked at over 850 ° C and slowly polymerized at a scientifically determined rate to ensure uniform depth and strength Ever Clean enamel creates an impeccable finish both on the inside of the oven and on the trays, making the surfaces of the oven incredibly easy to maintain over time as it reduces the adhesion of fat during cooking</p>
 <p>Fresh Touch: Most of Smeg ovens have a "cool door." Thanks to the combination of tangential cooling and internal heat-reflecting glasses, the temperature on the outer surface of the door is maintained below 50° C. In addition to providing safety, this system protects the sides of the furniture from overheating by the oven.</p>	 <p>Fan assisted base: the mix of fan and lower heating element alone allows to finish cooking foods already cooked on the surface but not internally more quickly. This system is recommended to finish cooking foods that are already well cooked on the surface, but not internally, which therefore require a moderate higher heat. Ideal for any type of food.</p>
 <p>Fan assisted: Intense and homogeneous traditional cooking, also suitable for complex recipes. The fan is active and the heat comes from below and from above at the same time. Ventilated cooking ensures a faster and more homogeneous result, leaving fragrant foods outside and moister inside. Ideal for baked pasta, biscuits, roasts and cobblers.</p>	 <p>Static: Traditional cooking suitable for the preparation of one dish at a time. The fan is not active and the heat comes from below and from above at the same time. Static cooking is slower and more delicate, ideal in order to get well cooked and dry dishes even inside. Ideal for cooking all types of roasts, fatty meats, bread, filled cakes.</p>
 <p>Base: the heat comes only from the bottom of the cavity. The fan is not active. Ideal for sweet and savory pies, cobblers and pizzas. Designed to complete cooking and make food more crunchy This symbol in gas ovens indicates the gas burner.</p>	 <p>Circulaire: it is the perfect function for cooking all types of dishes in a more delicate way. The heat comes from the back of the oven and is distributed quickly and evenly The fan is active. It is also ideal for cooking on multiple levels without mixing smells and flavors.</p>

-  **ECO:** low energy consumption cooking: this function is particularly suitable for cooking on a single shelf with low energy consumption. It is recommended for all types of food except those that can generate a lot of moisture (for example vegetables). To achieve maximum energy savings and reduce time, it is recommended to put the food in the oven without preheating the cooking compartment
-  **Fan grill:** very intense heat coming only from above from a double heating element The fan is active. It allows the optimal grilling of thickest meats. Ideal for large cuts of meat.
-  **The inner door glass:** can be removed with a few quick movements for cleaning.
-  **Side lights:** Two opposing side lights increase visibility inside the oven.
-  **Air at 40°C** provides the perfect environment for proving yeast type dough mixes. Simply select the function and place dough in the cavity for allotted
-  **The oven cavity has 5 different cooking levels.**
-  **Telescopic rails:** allow you to pull out the dish and check it without having to remove it from the oven entirely.
-  **The capacity indicates the amount of usable space in the oven cavity in litres.**
-  **Grill:** Very intense heat coming only from above from a double heating element. The fan is not active. Provides excellent grilling and gratinating results. Used at the end of cooking, it gives a uniform browning to dishes.
-  **Turbo:** the heat comes from 3 directions: above, below and from the back of the oven The fan is active. It allows quick cooking, even on several shelves without mixing the aromas. Ideal for large volumes or foods that require intense cooking.
-  **KEEP_WARM_72dpi**
-  **ECO-logic:** option allows you to restrict the power limit of the appliance real energy saving.
-  **SABBATH:** function that allows to cook food respecting Judaism's day of rest provisions.
-  **Soft close:** all models are equipped with advanced function of smooth closing of the door, which allows the device to close smoothly and quietly.
-  **Vapor Clean:** a simple cleaning function using steam to loosen deposits in the oven cavity.