

SI1F7845B



Product Family	Hob
Built-in	Ultra-low profile
Dimensions	78 cm
Power supply	Electric
Type	Induction
EAN code	8017709254926



Aesthetics



Aesthetics	Universal
Colour	Black
Finishing	Glass
Material	Glass
Glass Type	Ceramic
Glass edge	Bevelled Front Edge
Type of control setting	Multi Slider
Slider	Yes
Slider	Red
Control knobs position	Front
Serigraphy colour	Grey

Options



Flexible Zone Type	Flexi4Zone	Limited Power Consumption Mode	Yes advance
Standard cut out	490x750-780 mm	Limited Power Consumption Mode in W	1500, 2000, 2500, 3000, 3500, 4000, 4500, 5000, 6000, 7200 W
End cooking timer	4	Show Room Demo Option	Yes
Pause option	Yes	Control Lock / Child Safety	Yes
Minute minder	4	Rapid level selection	Yes
End of cooking acoustic alarm	Yes	Flexi-Heat	Yes
Residual time indicator	Yes		

Technical Features



Front left - Induzione - Flexi4Zone - 2.30 kW - Booster 3.20 kW - Ø 22 cm

Rear left - Induzione - Flexi4Zone - 2.30 kW - Booster 3.20 kW - Ø 22 cm

Front right - Induction - single - 1.80 kW - Booster 2.80 kW - Ø 18 cm

Rear right - Induction - single - 2.30 kW - Booster 3.20 kW - Ø 21 cm

Flexi4Zone dimensions	459x214 mm	Automatic switch off when overheat	Yes
Automatic setting according to pan dimension	Yes	Automatic switch off when overflow	Yes
Automatic pan detection	Yes	Eco-Heat	Yes
Minimum pan diameter indication	Yes	Eco-Off	Yes

Electrical Connection

Nominal power (W)	7200 W	Type of electric cable	Universal
Current	32 A	Frequency (Hz)	50/60 Hz
Voltage (V)	220-240 V	Power supply cable length	150 cm
Voltage 2 (V)	400 V	Terminal Box	5 poles

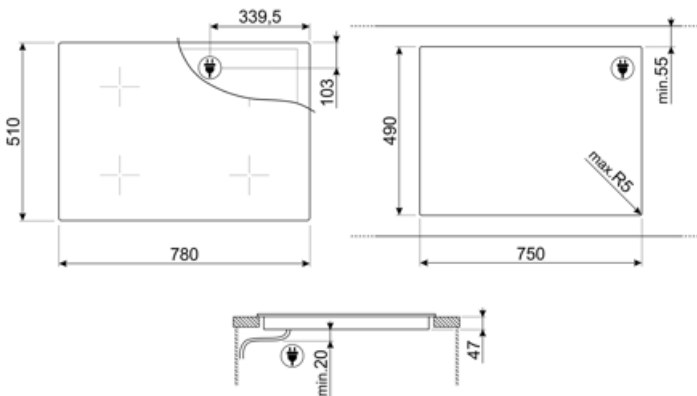

Not included accessories



SCRP

Induction and ceramic hobs and teppanyaki scraper



TPK

Stainless steel grill plate to cook Teppanyaki dishes



LGCN



















Connecting Strip Built-in hobs, stainless steel, 475/495 mm



TPKPLATE

Universal plate for induction, gas, ceramic and electric hobs. Non-stick surface ideal for cooking fish, eggs and vegetables. Dimensions: 410 X 240 mm.

Symbols glossary

 <p>A smart infrared system, which allows a hood and hob with this feature to work together.</p>	 <p>Power booster: option allows the zone to work at full power when very intense cooking is necessary.</p>
 <p>Ultra-low profile: Installation of product with flat edge - height of 1 mm.</p>	 <p>Child lock: some models are fitted with a device to lock the programme/cycle so it cannot be accidentally changed.</p>
 <p>The slider control panel allows you to adjust the power simply by passing your finger across the touch device.</p>	 <p>Eco-Heat: this function warns when the zone is still hot after being switched off. As well as ensuring maximum safety by preventing burns, this also allows you to make use of residual heat to continue cooking or keep foods hot.</p>
 <p>Eco-Off: This energy-saving function shuts the zone down before the timer sounds, making use of the residual heat in the pan.</p>	 <p>This function allows you to move pans between three preset temperature zones, to quickly heat (high temperature), cook (medium temperature) or keep foodstuffs warm (minimum temperature), without the need to raise or lower the temperature – simply move pans between the three zones, as required. The preset power levels can also be modified.</p>
 <p>This function allows you to use multiple pans of various dimensions (minimum diameter 10 cm) at the same time, increasing flexibility of positioning.</p>	 <p>Overheat protection: The safety system that automatically turns off the hob in case of overheating of the control unit.</p>
 <p>Induction: The work of these hobs is based on the principle of electromagnetic induction. The heat is generated directly in the bottom of the pan during its contact with the hob.</p>	 <p>Overfill protection: The special overfill protection shuts down the stove in the presence of overflow of liquids.</p>
 <p>PAUSE_72dpi</p>	 <p>Quick selection, with one touch cooking begins at the highest level, then automatically reduces after time. Ideal for dishes that require quick boiling and then continued cooking without constant control (eg beef broth).</p>
 <p>Time elapsed: shows how long the cooking zone has been in use.</p>	 <p>Timer: All ceramic hobs have a timer which automatically ends cooking after a preset time.</p>
 <p>...</p>	 <p>Perfect fit in a 80 cm cabinet</p>
 <p>Premium individual Slider control for each zone</p>	