

SI1F7845B



Product Family	Hob
Built-in type	Ultra-low profile
Dimensions	78 cm
Power supply	Electric
Type	Induction
EAN code	8017709254926



Aesthetics



Aesthetic	Universale
Colour	Black
Finishing	Glass
Material	Glass
Glass type	Ceramic
Glass edge	Bevelled Front Edge
Type of control setting	Multi Slider
Slider	Yes
LED colours	Red
Control knob position	Front
Logo	Silk screen
Serigraphy colour	Grey

Program / Functions

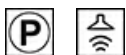

No. of induction cook zones	4
No. of cooking zones with booster	4
No. of Flexible zones	1
Main on/off switch	Yes
Power levels	14
Auto-Vent	Yes
Total no. of cook zones	4

Options



Flexible Zone Type	Flexi4Zone	Residual time indicator	Yes
Worktop Cut-Out	490x750-780 mm	Limited Power	Si Advance
End cooking timer	4	Consumption Mode	
Pause option	Yes	Limited Power	1500, 2000, 2500, 3000,
Minute minder	4	Consumption Mode in W	3500, 4000, 4500, 5000,
End of cooking alarm	Yes		6000, 7200 W
		Showroom Demo Option	Yes
		Control Lock / Child Safety	Yes
		Rapid level selection	Yes

Technical Features



Front-left - Induzione - Flexi4Zone - 2.30 kW - Booster 3.20 kW - Ø 22 cm
 Rear-left - Induzione - Flexi4Zone - 2.30 kW - Booster 3.20 kW - Ø 22 cm
 Front-right - Induction - Single - 1.80 kW - Booster 2.80 kW - Ø 18 cm
 Rear-right - Induction - Single - 2.30 kW - Booster 3.20 kW - Ø 21 cm

Automatic setting according to pan dimension	Yes	Automatic switch off when overflow	Yes
pan detection	Yes	Eco-Heat	Yes
Minimum pan diameter indication	Yes	Eco-Off	Yes
Automatic switch off when overheat	Yes		

Electrical Connection

Electrical connection rating (W)	7200 W	Frequency (Hz)	50/60 Hz
Current	32 A	Power supply cable length	150 cm
Voltage (V)	220-240 V	Terminal box	5 poles
Voltage 2 (V)	400 V	Plug	Not present
Type of electric cable installed	Universal		

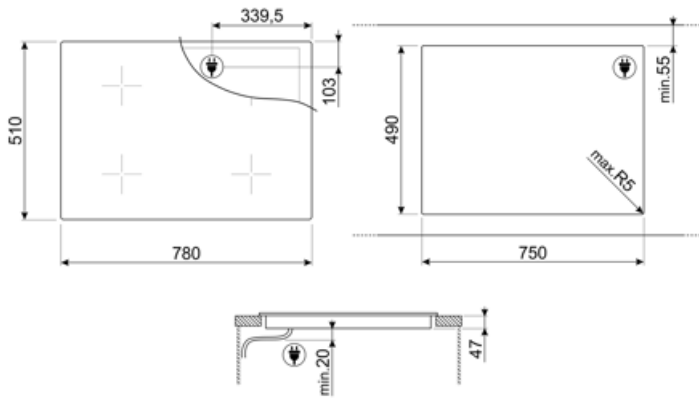

Compatible Accessories



LGCN

Connecting Strip Built-in hobs, stainless steel, 475/495 mm



SCRP

















Non-scratch hob scraper - suitable for induction and ceramic hobs

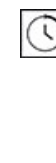

TPKPLATE

Universal plate for induction, gas, ceramic and electric hobs. Non-stick surface ideal for cooking fish, eggs and vegetables. Dimensions: 410 X 240 mm.

Symbols glossary

 <p>A smart infrared system, which allows a hood and hob with this feature to work together.</p>	 <p>Power booster: option allows the zone to work at full power when very intense cooking is necessary.</p>
 <p>Ultra-low profile: Installation of product with flat edge - height of 1 mm.</p>	 <p>Child lock: some models are fitted with a device to lock the programme/cycle so it cannot be accidentally changed.</p>
 <p>The slider control panel allows you to adjust the power simply by passing your finger across the touch device.</p>	 <p>Eco-Heat: this function warns when the zone is still hot after being switched off. As well as ensuring maximum safety by preventing burns, this also allows you to make use of residual heat to continue cooking or keep foods hot.</p>
 <p>Eco-Off: This energy-saving function shuts the zone down before the timer sounds, making use of the residual heat in the pan.</p>	 <p>This function allows you to use multiple pans of various dimensions (minimum diameter 10 cm) at the same time, increasing flexibility of positioning.</p>
 <p>Overheat protection: The safety system that automatically turns off the hob in case of overheating of the control unit.</p>	 <p>Induction: The work of these hobs is based on the principle of electromagnetic induction. The heat is generated directly in the bottom of the pan during its contact with the hob.</p>
 <p>Overfill protection: The special overfill protection shuts down the stove in the presence of overflow of liquids.</p>	 <p>All cooking zones can be reduced to the minimum power level, so the hob can be left unattended for a short period without food overcooking or burning. Then just press again this function, the previously set power levels can be reactivated.</p>
 <p>Quick selection, with one touch cooking begins at the highest level, then automatically reduces after time. Ideal for dishes that require quick boiling and then continued cooking without constant control (eg beef broth).</p>	 <p>Time elapsed: shows how long the cooking zone has been in use.</p>
 <p>Timer: All ceramic hobs have a timer which automatically ends cooking after a preset time.</p>	 <p>Possibility to set the maximum power absorption of the hob.</p>
 <p>Perfect fit in a 80 cm cabinet</p>	 <p>Premium individual Slider control for each zone</p>