

# SI1M4744D

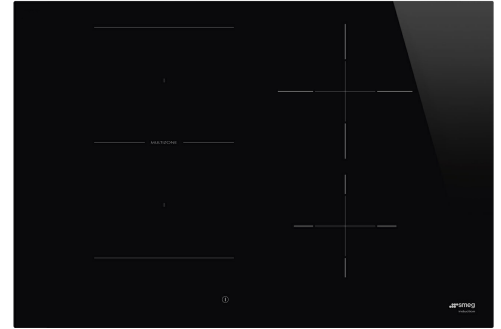

Product Family	Hob
Built-in type	Ultra-low profile or Fully Flushed
Dimensions	70/75 cm
Power supply	Electric
Type	Induction
EAN code	8017709305628



## Aesthetics



Aesthetic	Classic
Colour	Black
Finishing	Glass
Material	Glass
Glass type	Ceramic
Glass edge	Straight edge
Type of control setting	Compact EVO Slider
Slider	Yes
Slider	Red
Control knob position	Front
Serigraphy colour	Grey

## Program / Functions



No. of induction cook zones	4
Time-setting options	Automatic Shutdown
No. of cooking zones with booster	4
No. of Flexible zones	1
Main on/off switch	Yes
Power levels	9
Auto-vent 2.0	Si
Total no. of cook zones	4

## Options



<b>Multizone Option</b>	Yes	<b>End of cooking alarm</b>	Yes
<b>Flexible Zone Type</b>	MultiZone	<b>Residual time indicator</b>	Yes
<b>Standard cut out</b>	478-482x555-560 mm	<b>Limited Power Consumption Mode</b>	Advanced Eco Logic
<b>Multizone Option</b>	Yes	<b>Limited Power Consumption Mode in W</b>	2400 a 7400 - step 100 W
<b>Multizone Option</b>	Yes	<b>Showroom Demo Option</b>	Yes
<b>Keep warm automatic function</b>	Yes	<b>Control Lock / Child Safety</b>	Yes
<b>Grill function</b>	Yes	<b>Bridge option</b>	Yes
<b>End cooking timer</b>	4	<b>Cleaning option</b>	Yes
<b>Pause option</b>	Yes	<b>Quick start</b>	Yes
<b>Minute minder</b>	1	<b>Rapid level selection</b>	Yes

## Technical Features



Front-left - Induction - Multizone - 2.10 kW - Booster 2.50 kW - 21.8x18.0 cm  
 Rear-left - Induction - Multizone - 2.10 kW - Booster 2.50 kW - Double booster 3.00 kW - 21.8x18.0 cm  
 Rear-right - Induction - Single - 2.30 kW - Booster 3.00 kW - Double booster 3.00 kW - - Ø 21.0 cm  
 Front-right - Induction - Single - 1.40 kW - Booster 2.10 kW - - Ø 16.0 cm  
 Multizone left - Booster 3.70 kW - 38.5x23.0 cm

<b>Automatic setting according to pan dimension</b>	Yes	<b>Automatic switch off when overflow</b>	Yes
<b>pan detection</b>	Yes, min 7 cm	<b>Residual heat indicator</b>	Yes
<b>Permanent Automatic Pot Detection with indication of the relative control</b>	Yes	<b>Eco-Heat</b>	Yes
<b>Minimum pan diameter indication</b>	Yes	<b>Protection against accidental start up</b>	Yes
<b>Automatic switch off when overheat</b>	Yes		

## Electrical Connection

<b>Electrical connection rating (W)</b>	7400 W	<b>Type of electric cable</b>	Yes, Double and Three Phase
<b>Current</b>	33 A	<b>Frequency (Hz)</b>	50/60 Hz
<b>Voltage (V)</b>	220-240 V	<b>Power supply cable length</b>	120 cm
<b>Voltage 2 (V)</b>	380-415 V	<b>Terminal box</b>	5 poles
<b>Type of electric cable</b>	Single phase		

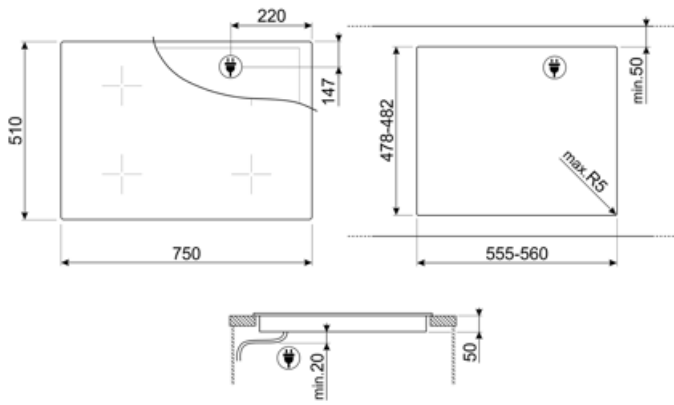

---

## Compatible Accessories

---



### GRILLPLATE

Universal griddle for induction, gas, ceramic and electric hobs. Non-stick surface ideal for cooking meat, cheese and vegetables. Dimensions: 410 x 240 mm.



### TPKPLATE

























Universal plate for induction, gas, ceramic and electric hobs. Non-stick surface ideal for cooking fish, eggs and vegetables. Dimensions: 410 X 240 mm.



### SCRP

Induction and ceramic hobs and teppanyaki scraper

## Symbols glossary

 <p>Power booster: option allows the zone to work at full power when very intense cooking is necessary.</p>	 <p>Child lock: some models are fitted with a device to lock the programme/cycle so it cannot be accidentally changed.</p>
 <p>The slider control panel allows you to adjust the power simply by passing your finger across the touch device.</p>	 <p>CUT_OUT_STANDAR_72dpi</p>
 <p>Eco-Heat: this function warns when the zone is still hot after being switched off. As well as ensuring maximum safety by preventing burns, this also allows you to make use of residual heat to continue cooking or keep foods hot.</p>	 <p>Keep warm function: Keep warm function keeps the cooked food heated. In this mode the heating zone operates at a minimum capacity for 120 minutes and then turns off automatically.</p>
 <p>Overheat protection: The safety system that automatically turns off the hob in case of overheating of the control unit.</p>	 <p>Induction: The work of these hobs is based on the principle of electromagnetic induction. The heat is generated directly in the bottom of the pan during its contact with the hob.</p>
 <p>Multizone: allows several pans to be used at once, large or small, offering freedom of placement and greater flexibility</p>	 <p>Overfill protection: The special overfill protection shuts down the stove in the presence of overflow of liquids.</p>
 <p>PAUSE_72dpi</p>	 <p>Quick selection, with one touch cooking begins at the highest level, then automatically reduces after time. Ideal for dishes that require quick boiling and then continued cooking without constant control (eg beef broth).</p>
 <p>Quick Start function: the chosen temperature is reached faster. The heating element works at maximum power until the right temperature is reached.</p>	 <p>Indication of residual heat: After the glass ceramic hob is switched off the residual heat indicator shows which of the heating zones still remains hot. When the temperature drops below 60 ° C, the indicator goes out.</p>
 <p>Time elapsed: shows how long the cooking zone has been in use.</p>	 <p>Timer: All ceramic hobs have a timer which automatically ends cooking after a preset time.</p>
 <p>TWIN_ZONE_72dpi</p>	 <p>...</p>
 <p>...</p>	 <p>...</p>
 <p>...</p>	 <p>...</p>
 <p>Additional maximum power level for a better energy consumption</p>	 <p>Compact Slider back-lighted ghost effect</p>
 <p>Automatic merge of zones for a bigger area</p>	

## Benefit (TT)

---

### **Induction hobs**

Fast cooking and precise temperature control

Immediate access to functions via touch display, for simple and intuitive control

### **Keep Warm function**

Dishes always served at the right temperature, even after cooking, thanks to the Keep Warm function

Nine power levels and Boost function for optimal cooking performance

### **MultiZone**

Large surface created by joining two contiguous zones, perfect for large dishes

In addition to their sleek aesthetics and contemporary design, Smeg induction hobs are equipped with innovative technologies. The Multizone function guarantees maximum flexibility in the use of the hob and endless cooking possibilities, expanding the cooking area to suit the shape and size of different pans

### **Grill function**

Even heat distribution with the grill function, requiring just two minutes of preheating for perfectly grilled dish

### **Permanent Automatic Pot Detection with indication of the relative control**

Automatic activation of the correct cooking zone with Autopot Detection, recognizing the pot without user intervention

### **Auto-vent 2.0**

Cooktop and hood connected via Bluetooth for synchronized and automatic operation