

SI1M4744D

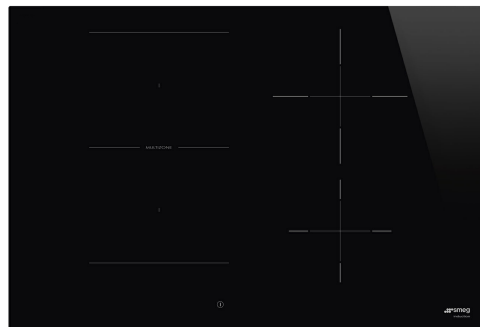

Familie	Kookplaat
Inbouw	Vlak opbouw of vlak inbouw
Afmeting	70/75 cm
Voeding	Elektrisch
Type	Inductie
EAN-code	8017709305628



Design



Esthetiek	Classici
Kleur	Zwart
Afwerking	Glas
Materiaal	Glas
Type glas	Keramisch
Glazen rand	Rechte rand
Type bediening	Compact Slider Plus
Slider	Ja
Slider	Rood
Positie bediening	Voor
Kleur serigrafie	Grijs

Programma's / functies



Aantal inductiekookzones	4
Opties tijdprogrammering	Automatische uitschakeling
Aantal kookzones met booster	4
Aantal Multizones	1
Hoofdtoets aan/uit	Ja
Vermogenniveaus	9
Auto-vent 2.0	Ja
Totaal aantal kookzones	4

Opties

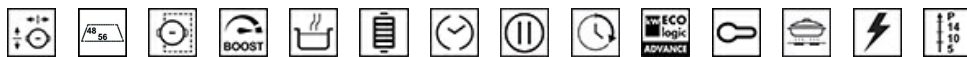

Multizone optie	Ja	Akoestisch signaal einde kooktijd	Ja
Flexible Zone Type	MultiZone	Resttijd indicator	Ja
Worktop Cut-Out	478-482x555-560 mm	ECO-Logic optie	Ja, Advance
Multizone optie	Ja	ECO-Logic optie - stappen	2400 a 7400 - step 100 W
Multizone optie	Ja	Showroom demo optie	Ja
Warmhoudfunctie	Ja	Kinderbeveiliging	Ja
Grill functie	Ja	TwinZone optie	Ja
Automatische uitschakeling	4	Optie Toetsblokkering t.b.v. reiniging	Ja
Pauze optie	Ja	Quick start	Ja
Timer	1	Snelle selectie niveaus	Ja

Technische specificaties

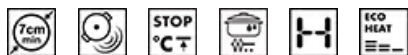

Linksvoor - Inductie - Multizone - 2.10 kW - Booster 2.50 kW - 21.8x18.0 cm
 Linksachter - Inductie - Multizone - 2.10 kW - Booster 2.50 kW - Double booster 3.00 kW - 21.8x18.0 cm
 Rechtsachter - Inductie - enkel - 2.30 kW - Booster 3.00 kW - Double booster 3.00 kW - - Ø 21.0 cm
 Rechtsvoor - Inductie - enkel - 1.40 kW - Booster 2.10 kW - - Ø 16.0 cm
 Multizone left - Booster 3.70 kW - 38.5x23.0 cm

Automatische herkenning panafmeting	Ja	Automatisch uitschakelen i.g.v. overkoken	Ja
Automatische panherkenning	minimaal 7 cm	Restwarmte indicator	Ja
Permanente automatische pandetectie met indicatie van de relatieve controle	Ja	Eco-Heat beveiliging tegen onbedoeld inschakeling	Ja
Indicator minimaal te gebruiken diameter	Ja		
Automatische stop bij oververhitting	Ja		

Elektrische aansluiting

Aansluitwaarde Stroom	7400 W 33 A	Type stroomkabel	Yes, Double and Three Phase
Spanning (V)	220-240 V	Frequentie	50/60 Hz
Spanning 2 (V)	380-415 V	Lengte voedingskabel	120 cm
Type stroomkabel	Eenfasig	Connection box	5 polig

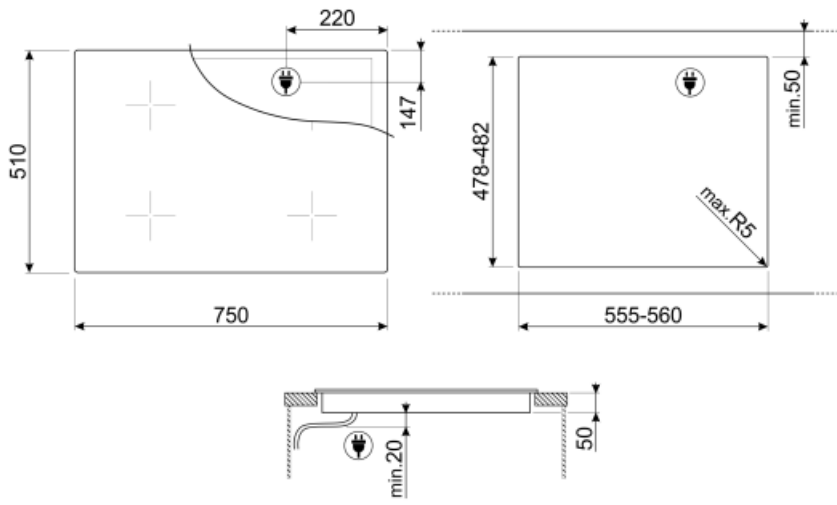

Accessoires niet inbegrepen



GRILLPLATE

Universal griddle for induction, gas, ceramic and electric hobs. Non-stick surface ideal for cooking meat, cheese and vegetables. Dimensions: 410 x 240 mm.



TPKPLATE

























Universal plate for induction, gas, ceramic and electric hobs. Non-stick surface ideal for cooking fish, eggs and vegetables. Dimensions: 410 X 240 mm.



SCRP

Inductie- en keramische kookplaten en teppanyaki-schraper

Symbols glossary (TT)

	Automatic merge of zones for a bigger area		Permanent auto pot detection
	Powerbooster: optie zorgt ervoor dat de zone op vol vermogen werkt wanneer zeer intensief koken nodig is.		Kinderslot: sommige modellen zijn voorzien van een apparaat om het programma / de cyclus te vergrendelen zodat het niet kan per ongeluk veranderd
	The slider control panel allows you to adjust the power simply by passing your finger across the touch device.		CUT_OUT_STANDARD_72dpi
	Eco-Heat: deze functie waarschuwt wanneer de zone na het uitschakelen nog warm is. Dit zorgt niet alleen voor maximale veiligheid door brandwonden te voorkomen, maar ook om de restwarmte te gebruiken om door te koken of om voedsel warm te houden.		This function allows you to keep cooked food warm without burner it
	Overheat protection: The safety system that automatically turns off the hob in case of overheating of the control unit.		Induction: The work of these hobs is based on the principle of electromagnetic induction. The heat is generated directly in the bottom of the pan during its contact with the hob.
	Connection between hob and hood		Multizone: allows several pans to be used at once, large or small, offering freedom of placement and greater flexibility
	Overfill protection: The special overfill protection shuts down the stove in the presence of overflow of liquids.		All cooking zones can be reduced to the minimum power level, so the hob can be left unattended for a short period without food overcooking or burning. Then just press again this function, the previously set power levels can be reactivated.
	Quick selection, with one touch cooking begins at the highest level, then automatically reduces after time. Ideal for dishes that require quick boiling and then continued cooking without constant control (eg beef broth).		Quick Start function: the chosen temperature is reached faster. The heating element works at maximum power until the right temperature is reached.
	Indication of residual heat: After the glass ceramic hob is switched off the residual heat indicator shows which of the heating zones still remains hot. When the temperature drops below 60 ° C, the indicator goes out.		Time elapsed: shows how long the cooking zone has been in use.
	Timer: All ceramic hobs have a timer which automatically ends cooking after a preset time.		TWIN_ZONE_72dpi
	Grill function		Min diameter pot detection of 7 cm
	Possibility to set the maximum power absorption of the hob		Additional maximum power level for a better energy consumption



Compact Slider back-lighted ghost effect