

## SI1M7643B



Product familie  
Type  
Afmeting  
Voeding  
Type  
EAN-code

Kookplaat  
Vlak opbouw  
60 cm  
Elektrisch  
Inductie  
8017709254971



## Design



Design

Kleur

Afwerking

Materiaal

Type glas

Glazen rand

Bediening

Slider bediening

Kleur LED

Positie bediening

Kleur serigrafie

Universeel

Zwart

Glas

Glas

Keramisch

Facetrand vooraan

Multi Slider

Ja

Rood

Vooraan

Grijs

## Programma's / Functies



Totaal aantal kookzones

4

Aantal inductiekookzones

4

Aantal kookzones met booster

4

Aantal Multizones

1

Hoofdtoets aan/uit

Ja

Vermogenniveaus

14

Auto-Vent

Ja

## Opties



<b>Multizone</b>	Ja	<b>Resttijd indicator</b>	Ja
<b>Flexible Zone Type</b>	MultiZone	<b>ECO-Logic optie</b>	Si Advance
<b>Worktop Cut-Out</b>	490x560 mm	<b>Beperkt vermogensverbruik</b>	1500, 2000, 2500, 3000, 3500, 4000, 4500, 5000, 6000, 7200 W
<b>Automatische uitschakeling</b>	4	<b>Showroom demo optie</b>	Ja
<b>Pauze optie</b>	Ja	<b>Kinderbeveiliging</b>	Ja
<b>Timer</b>	4	<b>Snelle selectie niveaus</b>	Ja
<b>Geluidssignaal einde kooktijd</b>	Ja		

## Technische specificaties



Linksvoor - Inductie - Multizone - 2.30 kW - Booster 3.20 kW - Ø 21 cm  
 Linksachter - Inductie - Multizone - 2.30 kW - Booster 3.20 kW - Ø 21 cm  
 Rechtsvoor - Inductie - enkel - 1.40 kW - Booster 2.50 kW - Ø 14.5 cm  
 Rechtsachter - Inductie - enkel - 1.80 kW - Booster 2.80 kW - Ø 18 cm

<b>Automatische aanpassing panafmeting</b>	Ja	<b>Automatisch uitschakelen i.g.v. overkoken</b>	Ja
<b>Automatische panherkenning</b>	Ja	<b>Eco-Heat</b>	Ja
<b>Indicator minimaal te gebruiken diameter</b>	Ja	<b>Eco-Off</b>	Ja
<b>Automatisch uitschakelen i.g.v. oververhitting</b>	Ja		

## Elektrische aansluiting

<b>Nominale aansluitwaarde</b>	7200 W	<b>Frequentie</b>	50/60 Hz
<b>Spanning (V)</b>	220-240 V	<b>Lengte voedingskabel</b>	150 cm
<b>Spanning 2 (V)</b>	400 V	<b>Aansluiting</b>	5 polig
<b>Type stroomkabel</b>	Universeel		

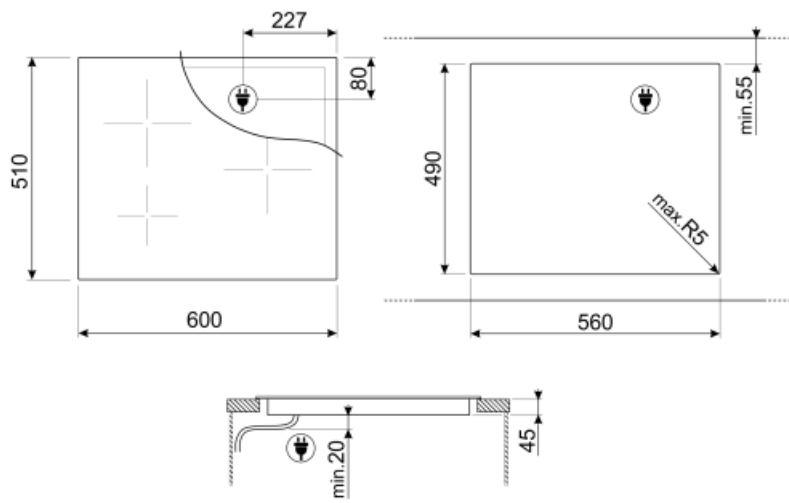

## Not included accessories

---



### GRILLPLATE

Universal griddle for induction, gas, ceramic and electric hobs. Non-stick surface ideal for cooking meat, cheese and vegetables. Dimensions: 410 x 240 mm.



### TPK

Inox teppan yaki grillplaat voor inductie



### SCRP

















Schraper voor inductie- en vitrokeramische kookplaten



### TPKPLATE

Universal plate for induction, gas, ceramic and electric hobs. Non-stick surface ideal for cooking fish, eggs and vegetables. Dimensions: 410 X 240 mm.

## Symbols glossary (TT)

 <p>A smart infrared system, which allows a hood and hob with this feature to work together.</p>	 <p>Power booster: option allows the zone to work at full power when very intense cooking is necessary.</p>
 <p>Ultra-low profile: Installation of product with flat edge - height of 1 mm.</p>	 <p>Sommige modellen zijn voorzien van een functie om het programma/de cyclus te blokkeren zodat het niet per ongeluk kan aangepast worden.</p>
 <p>Premium individual Slider control for each zone</p>	 <p>The slider control panel allows you to adjust the power simply by passing your finger across the touch device.</p>
 <p>Eco-Heat: this function warns when the zone is still hot after being switched off. As well as ensuring maximum safety by preventing burns, this also allows you to make use of residual heat to continue cooking or keep foods hot.</p>	 <p>Eco-Off: This energy-saving function shuts the zone down before the timer sounds, making use of the residual heat in the pan.</p>
 <p>Overheat protection: The safety system that automatically turns off the hob in case of overheating of the control unit.</p>	 <p>Induction: The work of these hobs is based on the principle of electromagnetic induction. The heat is generated directly in the bottom of the pan during its contact with the hob.</p>
 <p>Multizone: maakt het mogelijk meerdere pannen tegelijk te gebruiken, groot of klein, voor meer plaatsingsvrijheid en meer flexibiliteit</p>	 <p>Overflow protection: The special overflow protection shuts down the stove in the presence of overflow of liquids.</p>
 <p>All cooking zones can be reduced to the minimum power level, so the hob can be left unattended for a short period without food overcooking or burning. Then just press again this function, the previously set power levels can be reactivated.</p>	 <p>Quick selection, with one touch cooking begins at the highest level, then automatically reduces after time. Ideal for dishes that require quick boiling and then continued cooking without constant control (eg beef broth).</p>
 <p>Time elapsed: shows how long the cooking zone has been in use.</p>	 <p>Timer: All ceramic hobs have a timer which automatically ends cooking after a preset time.</p>
 <p>Possibility to set the maximum power absorption of the hob</p>	