

# SI2M7643DW

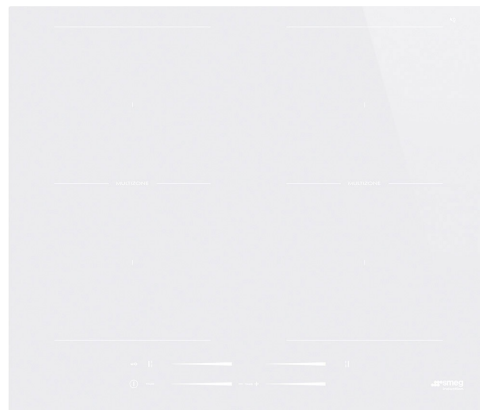

<b>Product Family</b>	Hob
<b>Built-in</b>	Ultra-low profile or Fully Flushed
<b>Dimensions</b>	60 cm
<b>Power supply</b>	Electric
<b>Type</b>	Induction
<b>EAN code</b>	8017709274832



## Aesthetics



<b>Aesthetics</b>	Universal
<b>Colour</b>	White
<b>Finishing</b>	Glass
<b>Material</b>	Glass
<b>Glass Type</b>	Ceramic
<b>Glass edge</b>	Straight edge
<b>Type of control setting</b>	Multi Slider
<b>Slider</b>	Yes
<b>Slider</b>	Red
<b>Control knobs position</b>	Front
<b>Serigraphy colour</b>	White

## Program / Functions



<b>No. of induction cook zones</b>	4
<b>No. of cooking zones with booster</b>	4
<b>No. of Flexible zones</b>	2
<b>Main on/off switch</b>	Yes
<b>Power levels</b>	14
<b>Total no. of cook zones</b>	4

## Options



<b>Multizone Option</b>	Yes	<b>Residual time indicator</b>	Yes
<b>Flexible Zone Type</b>	MultiZone	<b>Limited Power</b>	Yes advance
<b>Standard cut out</b>	490x560 mm	<b>Consumption Mode</b>	
<b>End cooking timer</b>	4	<b>Limited Power</b>	1500, 2000, 2500, 3000,
<b>Pause option</b>	Yes	<b>Consumption Mode in W</b>	3500, 4000, 4500, 5000,
<b>Minute minder</b>	4		6000, 7200 W
<b>End of cooking acoustic alarm</b>	Yes	<b>Show Room Demo Option</b>	Yes
		<b>Control Lock / Child Safety</b>	Yes
		<b>Rapid level selection</b>	Yes

## Technical Features



Front left - Induction - Multizone - 2.30 kW - Booster 3.20 kW - Ø 21 cm  
 Rear left - Induction - multizone - 2.30 kW - Booster 3.20 kW - Ø 21 cm  
 Front right - Induction - Multizone - 2.30 kW - Booster 3.20 kW - Ø 21 cm  
 Rear right - Induction - multizone - 2.30 kW - Booster 3.20 kW - Ø 21 cm  
 39.2x19.5 cm  
 39.2x19.5 cm

<b>Automatic setting according to pan dimension</b>	Yes	<b>Automatic switch off when overflow</b>	Yes
<b>Automatic pan detection</b>	Yes	<b>Eco-Heat</b>	Yes
<b>Minimum pan diameter indication</b>	Yes	<b>Eco-Off</b>	Yes
<b>Automatic switch off when overheat</b>	Yes		

## Electrical Connection

<b>Nominal power (W)</b>	7200 W	<b>Type of electric cable</b>	Universal
<b>Current</b>	32 A	<b>Frequency (Hz)</b>	50/60 Hz
<b>Voltage (V)</b>	220-240 V	<b>Power supply cable length</b>	150 cm
<b>Voltage 2 (V)</b>	400 V	<b>Terminal Box</b>	5 poles

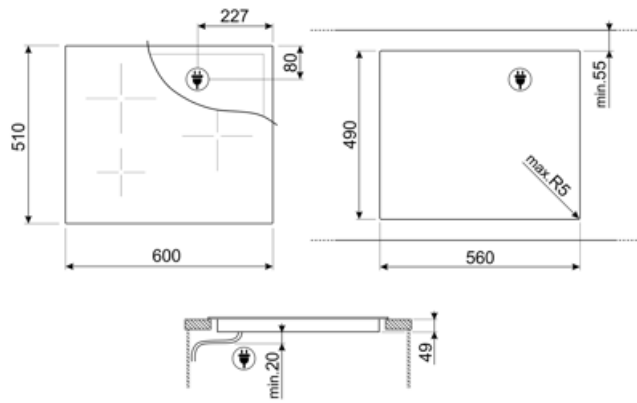

---

## Compatible Accessories

---



### GRILLPLATE

Universal griddle for induction, gas, ceramic and electric hobs. Non-stick surface ideal for cooking meat, cheese and vegetables. Dimensions: 410 x 240 mm.



### SCRP

Induction and ceramic hobs and teppanyaki scraper



### TPKPLATE

Universal plate for induction, gas, ceramic and electric hobs. Non-stick surface ideal for cooking fish, eggs and vegetables. Dimensions: 410 X 240 mm.



### LGCN















Connecting Strip Built-in hobs, stainless steel, 475/495 mm



### TPK

Stainless steel grill plate to cook Teppanyaki dishes

## Symbols glossary

 <p>Power booster: option allows the zone to work at full power when very intense cooking is necessary.</p>	 <p>Child lock: some models are fitted with a device to lock the programme/cycle so it cannot be accidentally changed.</p>
 <p>The slider control panel allows you to adjust the power simply by passing your finger across the touch device.</p>	 <p>Eco-Heat: this function warns when the zone is still hot after being switched off. As well as ensuring maximum safety by preventing burns, this also allows you to make use of residual heat to continue cooking or keep foods hot.</p>
 <p>Eco-Off: This energy-saving function shuts the zone down before the timer sounds, making use of the residual heat in the pan.</p>	 <p>Overheat protection: The safety system that automatically turns off the hob in case of overheating of the control unit.</p>
 <p>Induction: The work of these hobs is based on the principle of electromagnetic induction. The heat is generated directly in the bottom of the pan during its contact with the hob.</p>	 <p>Multizone: allows several pans to be used at once, large or small, offering freedom of placement and greater flexibility</p>
 <p>Overfill protection: The special overfill protection shuts down the stove in the presence of overflow of liquids.</p>	 <p>PAUSE_72dpi</p>
 <p>Quick selection, with one touch cooking begins at the highest level, then automatically reduces after time. Ideal for dishes that require quick boiling and then continued cooking without constant control (eg beef broth).</p>	 <p>Time elapsed: shows how long the cooking zone has been in use.</p>
 <p>Timer: All ceramic hobs have a timer which automatically ends cooking after a preset time.</p>	 <p>...</p>
 <p>Premium individual Slider control for each zone</p>	