

SI2M7643DW



Product Family	Hob
Built-in type	Ultra-low profile or Fully Flushed
Dimensions	60 cm
Power supply	Electric
Type	Induction
EAN code	8017709274832



Aesthetics



Aesthetic	Universale
Colour	White
Finishing	Glass
Material	Glass
Glass type	Ceramic
Glass edge	Straight edge
Type of control setting	Multi Slider
Slider	Yes
LED colours	Red
Control knob position	Front
Serigraphy colour	White

Programme / Functions



Total no. of cook zones	4
No. of induction cook zones	4
No. of cooking zones with booster	4
No. of Flexible zones	2
Main on/off switch	Yes
Power levels	14

Options



Multizone Option	Yes	Residual time indicator	Yes
Flexible Zone Type	MultiZone	Limited Power	Si Advance
Worktop Cut-Out	490x560 mm	Consumption Mode	
End cooking timer	4	Limited Power Consumption Mode in W	1500, 2000, 2500, 3000, 3500, 4000, 4500, 5000, 6000, 7200 W
Pause option	Yes	Showroom Demo Option	Yes
Minute minder	4	Control Lock / Child Safety	Yes
End of cooking alarm	Yes	Rapid level selection	Yes

Technical Features



Front-left - Induction - Multizone - 2.30 kW - Booster 3.20 kW - Ø 21 cm
 Rear-left - Induction - Multizone - 2.30 kW - Booster 3.20 kW - Ø 21 cm
 Front-right - Induction - Multizone - 2.30 kW - Booster 3.20 kW - Ø 21 cm
 Rear-right - Induction - Multizone - 2.30 kW - Booster 3.20 kW - Ø 21 cm
 39.2x19.5 cm
 39.2x19.5 cm

Automatic setting according to pan dimension	Yes	Automatic switch off when overflow	Yes
pan detection	Yes	Eco-Heat	Yes
Minimum pan diameter indication	Yes	Eco-Off	Yes
Automatic switch off when overheat	Yes		

Electrical Connection

Electrical connection rating (W)	7200 W	Type of electric cable installed	Universal
Current	32 A	Frequency (Hz)	50/60 Hz
Voltage (V)	220-240 V	Power supply cable length	150 cm
Voltage 2 (V)	400 V	Terminal box	5 poles

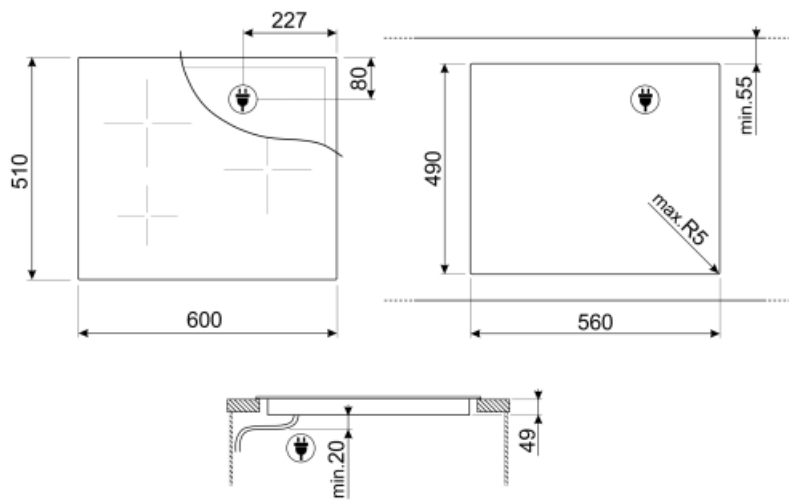

Not included accessories



GRILLPLATE

Universal griddle for induction, gas, ceramic and electric hobs. Non-stick surface ideal for cooking meat, cheese and vegetables. Dimensions: 410 x 240 mm.



TPK

Stainless steel grill plate to cook Teppanyaki dishes



TPKPLATE

Universal plate for induction, gas, ceramic and electric hobs. Non-stick surface ideal for cooking fish, eggs and vegetables. Dimensions: 410 X 240 mm.



SCRIP















Non-scratch hob scraper - suitable for induction and ceramic hobs



LGCN

Connecting Strip Built-in hobs, stainless steel, 475/495 mm

Symbols glossary (TT)

 <p>Power booster: option allows the zone to work at full power when very intense cooking is necessary.</p>	 <p>Child lock: some models are fitted with a device to lock the programme/cycle so it cannot be accidentally changed.</p>
 <p>Premium individual Slider control for each zone</p>	 <p>The slider control panel allows you to adjust the power simply by passing your finger across the touch device.</p>
 <p>Eco-Heat: this function warns when the zone is still hot after being switched off. As well as ensuring maximum safety by preventing burns, this also allows you to make use of residual heat to continue cooking or keep foods hot.</p>	 <p>Eco-Off: This energy-saving function shuts the zone down before the timer sounds, making use of the residual heat in the pan.</p>
 <p>Overheat protection: The safety system that automatically turns off the hob in case of overheating of the control unit.</p>	 <p>Induction: The work of these hobs is based on the principle of electromagnetic induction. The heat is generated directly in the bottom of the pan during its contact with the hob.</p>
 <p>Multizone: allows several pans to be used at once, large or small, offering freedom of placement and greater flexibility</p>	 <p>Overfill protection: The special overfill protection shuts down the stove in the presence of overflow of liquids.</p>
 <p>All cooking zones can be reduced to the minimum power level, so the hob can be left unattended for a short period without food overcooking or burning. Then just press again this function, the previously set power levels can be reactivated.</p>	 <p>Possibility to set the maximum power absorption of the hob</p>
 <p>Quick selection, with one touch cooking begins at the highest level, then automatically reduces after time. Ideal for dishes that require quick boiling and then continued cooking without constant control (eg beef broth).</p>	 <p>Time elapsed: shows how long the cooking zone has been in use.</p>
 <p>Timer: All ceramic hobs have a timer which automatically ends cooking after a preset time.</p>	