

SI2M7643FX



Product Family	Hob
Built-in	Traditional
Dimensions	60 cm
Power supply	Electric
Type	Induction
EAN code	8017709257927



Aesthetics



Aesthetics	Universal
Colour	Black
Finishing	Glass
Material	Glass
Glass Type	Ceramic
Frame	Yes
Frame colour	Stainless Steel
Type of control setting	Multi Slider
Slider	Yes
Slider	Red
Control knobs position	Front
Serigraphy colour	Grey

Program / Functions



No. of induction cook zones	4
No. of cooking zones with booster	4
No. of Flexible zones	2
Main on/off switch	Yes
Power levels	14
Auto-Vent	Yes
Total no. of cook zones	4

Options



Multizone Option	Yes	Residual time indicator	Yes
Flexible Zone Type	MultiZone	Limited Power Consumption Mode	Yes advance
Standard cut out	490x560 mm	Limited Power Consumption Mode in W	1500, 2000, 2500, 3000, 3500, 4000, 4500, 5000, 6000, 7200 W
End cooking timer	4	Show Room Demo Option	Yes
Minute minder	4	Control Lock / Child Safety	Yes
End of cooking acoustic alarm	Yes	Rapid level selection	Yes

Technical Features



Front left - Induction - Multizone - 2.30 kW - Booster 3.20 kW - Ø 21 cm
 Rear left - Induction - multizone - 2.30 kW - Booster 3.20 kW - Ø 21 cm
 Front right - Induction - Multizone - 2.30 kW - Booster 3.20 kW - Ø 21 cm
 Rear right - Induction - multizone - 2.30 kW - Booster 3.20 kW - Ø 21 cm
 39.2x19.5 cm
 39.2x19.5 cm

Automatic setting according to pan dimension	Yes	Automatic switch off when overflow	Yes
Automatic pan detection	Yes	Eco-Heat	Yes
Minimum pan diameter indication	Yes	Eco-Off	Yes
Automatic switch off when overheat	Yes		

Electrical Connection

Nominal power (W)	7200 W	Frequency (Hz)	50/60 Hz
Voltage (V)	220-240 V	Power supply cable length	150 cm
Voltage 2 (V)	400 V	Terminal Box	5 poles
Type of electric cable	Universal		

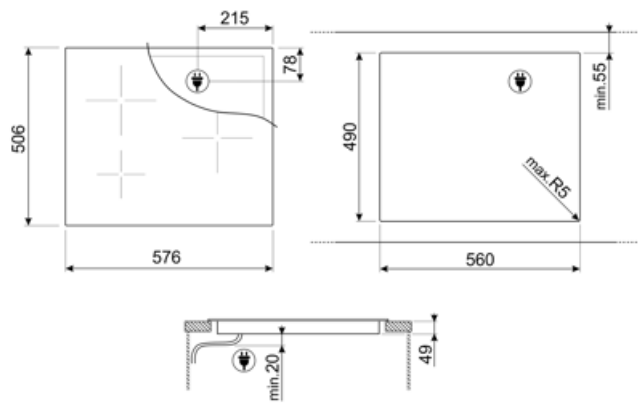

Compatible Accessories



SCRP

















Induction and ceramic hobs and teppanyaki scraper



TPK

Stainless steel grill plate to cook Teppanyaki dishes

Symbols glossary

 <p>A smart infrared system, which allows a hood and hob with this feature to work together.</p>	 <p>Power booster: option allows the zone to work at full power when very intense cooking is necessary.</p>
 <p>Standard installation: Traditional installation in tabletop, suitable for any kitchen sets</p>	 <p>Child lock: some models are fitted with a device to lock the programme/cycle so it cannot be accidentally changed.</p>
 <p>Premium individual Slider control for each zone</p>	 <p>The slider control panel allows you to adjust the power simply by passing your finger across the touch device.</p>
 <p>Eco-Heat: this function warns when the zone is still hot after being switched off. As well as ensuring maximum safety by preventing burns, this also allows you to make use of residual heat to continue cooking or keep foods hot.</p>	 <p>Eco-Off: This energy-saving function shuts the zone down before the timer sounds, making use of the residual heat in the pan.</p>
 <p>Overheat protection: The safety system that automatically turns off the hob in case of overheating of the control unit.</p>	 <p>Induction: The work of these hobs is based on the principle of electromagnetic induction. The heat is generated directly in the bottom of the pan during its contact with the hob.</p>
 <p>Multizone: allows several pans to be used at once, large or small, offering freedom of placement and greater flexibility</p>	 <p>Overfill protection: The special overfill protection shuts down the stove in the presence of overflow of liquids.</p>
 <p>Quick selection, with one touch cooking begins at the highest level, then automatically reduces after time. Ideal for dishes that require quick boiling and then continued cooking without constant control (eg beef broth).</p>	 <p>Time elapsed: shows how long the cooking zone has been in use.</p>
 <p>Timer: All ceramic hobs have a timer which automatically ends cooking after a preset time.</p>	 <p>...</p>