

SI2M7643FX



Familie
Inbouw
Afmeting
Voeding
Type
EAN-code

Kookplaat
Standaard
60 cm
Elektrisch
Inductie
8017709257927



Design



Esthetiek
Kleur
Afwerking
Materiaal
Type glas
Kader
Kleur kader
Type bediening
Slider
Slider
Positie bediening
Kleur serigrafie

Universeel
Zwart
Glas
Glas
Keramisch
Ja
Roestvrij staal
Multi Slider
Ja
Rood
Voor
Grijs

Program / Functions

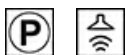

Aantal inductiekookzones
Aantal kookzones met booster
Aantal Multizones
Hoofdtoets aan/uit
Vermogenniveaus
Auto-Vent
Totaal aantal kookzones

4
4
2
Ja
14
Ja
4

Opties



Multizone optie	Ja	Resttijd indicator	Ja
Flexible Zone Type	MultiZone	ECO-Logic optie	Ja, Advance
Worktop Cut-Out	490x560 mm	ECO-Logic optie - stappen	1500, 2000, 2500, 3000, 3500, 4000, 4500, 5000, 6000, 7200 W
Automatische uitschakeling	4	Showroom demo optie	Ja
Timer	4	Kinderbeveiliging	Ja
Akoestisch signaal einde kooktijd	Ja	Snelle selectie niveaus	Ja

Technische specificaties



Linksvoor - Inductie - Multizone - 2.30 kW - Booster 3.20 kW - Ø 21 cm
 Linksachter - Inductie - Multizone - 2.30 kW - Booster 3.20 kW - Ø 21 cm
 Rechtsvoor - Inductie - Multizone - 2.30 kW - Booster 3.20 kW - Ø 21 cm
 Rechtsachter - Inductie - Multizone - 2.30 kW - Booster 3.20 kW - Ø 21 cm
 39.2x19.5 cm
 39.2x19.5 cm

Automatische herkenning panafmeting	Ja	Automatisch uitschakelen i.g.v. overkoken	Ja
Automatische panherkenning	Ja	Eco-Heat	Ja
Indicator minimaal te gebruiken diameter	Ja	Eco-Off	Ja
Automatische stop bij oververhitting	Ja		

Elektrische aansluiting

Aansluitwaarde	7200 W	Frequentie	50/60 Hz
Spanning (V)	220-240 V	Lengte voedingskabel	150 cm
Spanning 2 (V)	400 V	Connection box	5 polig
Type stroomkabel	Universeel	Stekker	No

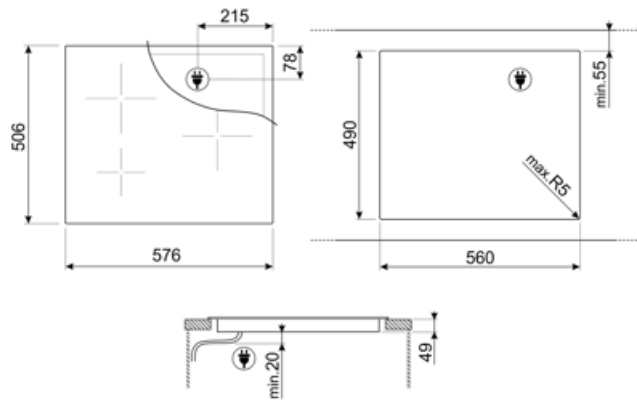

Compatibele Accessoires



SCRP

















Inductie- en keramische kookplaten en
teppanyaki-schraper



TPK

Roestvrijstalen grillplaat om
Teppanyaki-gerechten te bereiden

Symbols glossary

 <p>Een slim infrarood systeem, waardoor een afzuigkap en kookplaat met deze functie samenwerken.</p>	 <p>Powerbooster: optie zorgt ervoor dat de zone op vol vermogen werkt wanneer zeer intensief koken nodig is.</p>
 <p>Standard installation: Traditional installation in tabletop, suitable for any kitchen sets</p>	 <p>Kinderslot: sommige modellen zijn voorzien van een apparaat om het programma / de cyclus te vergrendelen zodat het niet kan per ongeluk veranderd</p>
 <p>Premium individual Slider control for each zone</p>	 <p>The slider control panel allows you to adjust the power simply by passing your finger across the touch device.</p>
 <p>Eco-Heat: deze functie waarschuwt wanneer de zone na het uitschakelen nog warm is. Dit zorgt niet alleen voor maximale veiligheid door brandwonden te voorkomen, maar ook om de restwarmte te gebruiken om door te koken of om voedsel warm te houden.</p>	 <p>Eco-Off: deze energiebesparende functie schakelt de zone uit voordat de timer klinkt, gebruikmakend van de restwarmte in de pan</p>
 <p>Overheat protection: The safety system that automatically turns off the hob in case of overheating of the control unit.</p>	 <p>Induction: The work of these hobs is based on the principle of electromagnetic induction. The heat is generated directly in the bottom of the pan during its contact with the hob.</p>
 <p>Multizone: allows several pans to be used at once, large or small, offering freedom of placement and greater flexibility</p>	 <p>Overfill protection: The special overfill protection shuts down the stove in the presence of overflow of liquids.</p>
 <p>Quick selection, with one touch cooking begins at the highest level, then automatically reduces after time. Ideal for dishes that require quick boiling and then continued cooking without constant control (eg beef broth).</p>	 <p>Time elapsed: shows how long the cooking zone has been in use.</p>
 <p>Timer: All ceramic hobs have a timer which automatically ends cooking after a preset time.</p>	 <p>Possibility to set the maximum power absorption of the hob</p>