

SI5322B

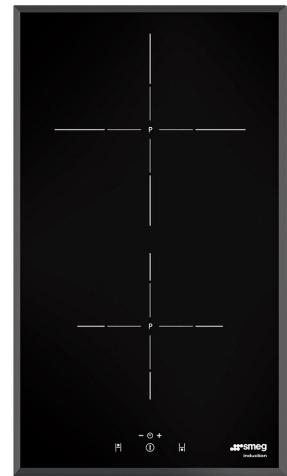

Product Family	Hob
Built-in type	Ultra-low profile
Dimensions	30 cm
Power supply	Electric
Type	Induction
EAN code	8017709193386



Aesthetics



Aesthetic	Universale
Colour	Black
Finishing	Glass
Material	Glass
Glass type	Ceramic
Glass edge	Angled edge
Type of control setting	Digi Touch
LED colours	Red
Control knob position	Front
Serigraphy colour	Grey

Programs / Functions



No. of induction cook zones	2
No. of cooking zones with booster	2
Main on/off switch	Yes
Power levels	9
Total no. of cook zones	2

Options



Worktop Cut-Out	490x270 mm	Residual time indicator	Yes
-----------------	------------	-------------------------	-----

End cooking timer	2	Control Lock / Child Safety	Yes
Minute minder	1	Quick start	Yes
End of cooking alarm	Yes		

Technical Features

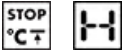

Front-centre - Induction - Single - 1.30 kW - Booster 1.40 kW - Ø 16.0 cm

Rear-centre - Induction - Single - 2.30 kW - Booster 3.00 kW - Ø 21.0 cm

Automatic setting according to pan dimension	Yes	Automatic switch off when overheat	Yes
pan detection	Yes	Residual heat indicator	Yes
Minimum pan diameter indication	Yes	Protection against accidental start up	Yes

Electrical Connection

Plug	Not present	Type of electric cable installed	Yes, Single phase
Electrical connection rating (W)	3500 W	Frequency (Hz)	50/60 Hz
Current	16 A	Power supply cable length	120 cm
Voltage (V)	220-240 V		

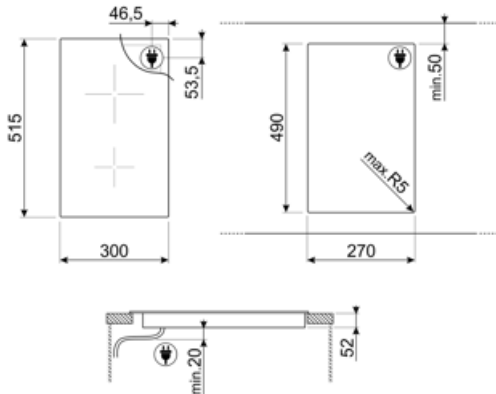

Compatible Accessories



SCRP











Non-scratch hob scraper - suitable for induction and ceramic hobs



TPK

Stainless steel grill plate to cook Teppanyaki dishes

Symbols glossary

	Power booster: option allows the zone to work at full power when very intense cooking is necessary.		Ultra-low profile: Installation of product with flat edge - height of 1 mm.
	Child lock: some models are fitted with a device to lock the programme/cycle so it cannot be accidentally changed.		Overheat protection: The safety system that automatically turns off the hob in case of overheating of the control unit.
	Induction: The work of these hobs is based on the principle of electromagnetic induction. The heat is generated directly in the bottom of the pan during its contact with the hob.		Quick Start function: the chosen temperature is reached faster. The heating element works at maximum power until the right temperature is reached.
	Indication of residual heat: After the glass ceramic hob is switched off the residual heat indicator shows which of the heating zones still remains hot. When the temperature drops below 60 ° C, the indicator goes out.		Time elapsed: shows how long the cooking zone has been in use.
	Timer: All ceramic hobs have a timer which automatically ends cooking after a preset time.		Touch control