

SI7633B



Product Family
Built-in type
Dimensions
Power supply
Type
EAN code

Hob
Ultra-low profile
60 cm
Electric
Induction
8017709254995



Aesthetics



| | |
|-------------------------|---------------------|
| Aesthetic | Universale |
| Colour | Black |
| Finishing | Glass |
| Material | Glass |
| Glass type | Ceramic |
| Glass edge | Bevelled Front Edge |
| Type of control setting | Multi Slider |
| Slider | Yes |
| LED colours | Red |
| Control knob position | Front |
| Serigraphy colour | Grey |

Programs / Functions main oven



| | |
|-----------------------------------|-----|
| No. of induction cook zones | 3 |
| No. of cooking zones with booster | 3 |
| Main on/off switch | Yes |
| Power levels | 14 |
| Auto-Vent | Yes |
| Total no. of cook zones | 3 |

Options



| | | | |
|-----------------------------|------------|------------------------------------|-----|
| Worktop Cut-Out | 490x560 mm | Residual time indicator | Yes |
| End cooking timer | 3 | Showroom Demo Option | Yes |
| Pause option | Yes | Control Lock / Child Safety | Yes |
| Minute minder | 3 | Rapid level selection | Yes |
| End of cooking alarm | Yes | | |

Technical Features



Front-left - Induction - Single - 2.30 kW - Booster 3.70 kW - Ø 21 cm
 Rear-left - Induction - Single - 1.40 kW - Booster 2.50 kW - Ø 14.5 cm
 Front-right - Induction - Giant - 1.80 - 2.80 kW - Booster 3.50 - 5.20 kW - Ø 18/28 cm

| | | | |
|---|-----|---|-----|
| Automatic setting according to pan dimension | Yes | Automatic switch off when overflow | Yes |
| pan detection | Yes | Eco-Heat | Yes |
| Minimum pan diameter indication | Yes | Eco-Off | Yes |
| Automatic switch off when overheat | Yes | | |

Electrical Connection

| | | | |
|---|-------------------|----------------------------------|----------|
| Plug | Not present | Frequency (Hz) | 50/60 Hz |
| Electrical connection rating (W) | 7350 W | Power supply cable length | 150 cm |
| Voltage (V) | 220-240 V | Terminal box | 6 poles |
| Type of electric cable installed | Yes, Single phase | | |

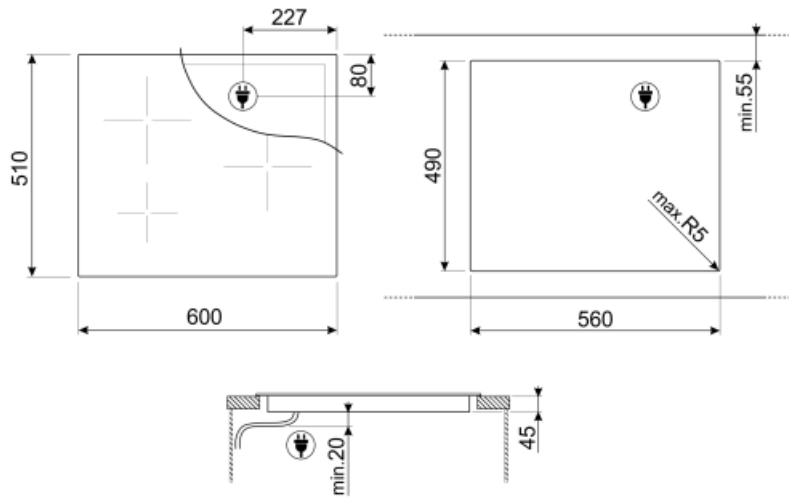

Not included accessories



GRILLPLATE

Universal griddle for induction, gas, ceramic and electric hobs. Non-stick surface ideal for cooking meat, cheese and vegetables. Dimensions: 410 x 240 mm.



SCRP

Non-scratch hob scraper - suitable for induction and ceramic hobs



TPK

















Stainless steel grill plate to cook Teppanyaki dishes



TPKPLATE

Universal plate for induction, gas, ceramic and electric hobs. Non-stick surface ideal for cooking fish, eggs and vegetables. Dimensions: 410 X 240 mm.

Symbols glossary (TT)

| | |
|--|--|
|  <p>A smart infrared system, which allows a hood and hob with this feature to work together.</p> |  <p>Power booster: option allows the zone to work at full power when very intense cooking is necessary.</p> |
|  <p>Ultra-low profile: Installation of product with flat edge - height of 1 mm.</p> |  <p>Child lock: some models are fitted with a device to lock the programme/cycle so it cannot be accidentally changed.</p> |
|  <p>The slider control panel allows you to adjust the power simply by passing your finger across the touch device.</p> |  <p>Eco-Heat: this function warns when the zone is still hot after being switched off. As well as ensuring maximum safety by preventing burns, this also allows you to make use of residual heat to continue cooking or keep foods hot.</p> |
|  <p>Eco-Off: This energy-saving function shuts the zone down before the timer sounds, making use of the residual heat in the pan.</p> |  <p>Giant zone: The giant zone offers extra space and flexibility.</p> |
|  <p>Overheat protection: The safety system that automatically turns off the hob in case of overheating of the control unit.</p> |  <p>Induction: The work of these hobs is based on the principle of electromagnetic induction. The heat is generated directly in the bottom of the pan during its contact with the hob.</p> |
|  <p>Overfill protection: The special overfill protection shuts down the stove in the presence of overflow of liquids.</p> |  <p>All cooking zones can be reduced to the minimum power level, so the hob can be left unattended for a short period without food overcooking or burning. Then just press again this function, the previously set power levels can be reactivated.</p> |
|  <p>Quick selection, with one touch cooking begins at the highest level, then automatically reduces after time. Ideal for dishes that require quick boiling and then continued cooking without constant control (eg beef broth).</p> |  <p>Time elapsed: shows how long the cooking zone has been in use.</p> |
|  <p>Timer: All ceramic hobs have a timer which automatically ends cooking after a preset time.</p> |  <p>Premium individual Slider control for each zone</p> |