

SI7643B



Product familie	Kookplaat
Type	Vlak opbouw
Afmeting	60 cm
Voeding	Elektrisch
Type	Inductie
EAN-code	8017709255015



Design



Design	Universeel
Kleur	Zwart
Afwerking	Glas
Materiaal	Glas
Type glas	Keramisch
Glazen rand	Facetrand vooraan
Bediening	Multi Slider
Slider bediening	Ja
Kleur LED	Rood
Positie bediening	Vooraan
Kleur serigrafie	Grijs

Programma's / Functies



Totaal aantal kookzones	4
Aantal inductiekookzones	4
Aantal kookzones met booster	4
Hoofdtoets aan/uit	Ja
Vermogenniveaus	14
Auto-Vent	Ja

Opties



Worktop Cut-Out	490x560 mm	ECO-Logic optie	Si Advance
Automatische uitschakeling	4	Beperkt vermogensverbruik	1500, 2000, 2500, 3000, 3500, 4000, 4500, 5000, 6000, 7200 W
Pauze optie	Ja	Showroom demo optie	Ja
Timer	4	Kinderbeveiliging	Ja
Geluidssignaal einde kooktijd	Ja	Snelle selectie niveaus	Ja
Resttijd indicator	Ja		

Technische specificaties



Linksvoor - Inductie - enkel - 2.30 kW - Booster 3.70 kW - Ø 21 cm
 Linksachter - Inductie - enkel - 1.80 kW - Booster 2.80 kW - Ø 18 cm
 Rechtsvoor - Inductie - enkel - 1.80 kW - Booster 2.80 kW - Ø 18 cm
 Rechtsachter - Inductie - enkel - 1.40 kW - Booster 2.50 kW - Ø 14.5 cm

Automatische aanpassing panafmeting	Ja	Automatisch uitschakelen i.g.v. overkoken	Ja
Automatische panherkenning	Ja	Eco-Heat	Ja
Indicator minimaal te gebruiken diameter	Ja	Eco-Off	Ja
Automatisch uitschakelen i.g.v. oververhitting	Ja		

Elektrische aansluiting

Nominale aansluitwaarde	7200 W	Frequentie	50/60 Hz
Spanning (V)	220-240 V	Lengte voedingskabel	150 cm
Spanning 2 (V)	400 V	Aansluiting	5 polig
Type stroomkabel	Universeel		

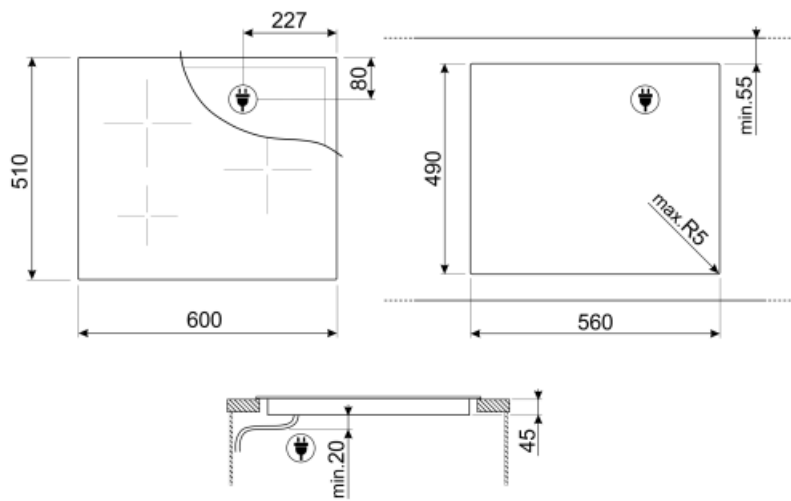

Not included accessories



GRILLPLATE

Universal griddle for induction, gas, ceramic and electric hobs. Non-stick surface ideal for cooking meat, cheese and vegetables. Dimensions: 410 x 240 mm.



TPK

Inox teppan yaki grillplaat voor inductie



TPKPLATE

Universal plate for induction, gas, ceramic and electric hobs. Non-stick surface ideal for cooking fish, eggs and vegetables. Dimensions: 410 X 240 mm.



SCRP

















Schraper voor inductie- en vitrokeramische kookplaten



LGCN

Connecting Strip Built-in hobs, stainless steel, 475/495 mm

Symbols glossary (TT)

 <p>A smart infrared system, which allows a hood and hob with this feature to work together.</p>	 <p>Power booster: option allows the zone to work at full power when very intense cooking is necessary.</p>
 <p>Ultra-low profile: Installation of product with flat edge - height of 1 mm.</p>	 <p>Sommige modellen zijn voorzien van een functie om het programma/de cyclus te blokkeren zodat het niet per ongeluk kan aangepast worden.</p>
 <p>The slider control panel allows you to adjust the power simply by passing your finger across the touch device.</p>	 <p>Eco-Heat: this function warns when the zone is still hot after being switched off. As well as ensuring maximum safety by preventing burns, this also allows you to make use of residual heat to continue cooking or keep foods hot.</p>
 <p>Eco-Off: This energy-saving function shuts the zone down before the timer sounds, making use of the residual heat in the pan.</p>	 <p>Overheat protection: The safety system that automatically turns off the hob in case of overheating of the control unit.</p>
 <p>Induction: The work of these hobs is based on the principle of electromagnetic induction. The heat is generated directly in the bottom of the pan during its contact with the hob.</p>	 <p>Overfill protection: The special overfill protection shuts down the stove in the presence of overflow of liquids.</p>
 <p>All cooking zones can be reduced to the minimum power level, so the hob can be left unattended for a short period without food overcooking or burning. Then just press again this function, the previously set power levels can be reactivated.</p>	 <p>Quick selection, with one touch cooking begins at the highest level, then automatically reduces after time. Ideal for dishes that require quick boiling and then continued cooking without constant control (eg beef broth).</p>
 <p>Time elapsed: shows how long the cooking zone has been in use.</p>	 <p>Timer: All ceramic hobs have a timer which automatically ends cooking after a preset time.</p>
 <p>Possibility to set the maximum power absorption of the hob</p>	 <p>Premium individual Slider control for each zone</p>