

SI7643B



Familie
Inbouw
Afmeting
Voeding
Type
EAN-code

Kookplaat
Vlak opbouw
60 cm
Elektrisch
Inductie
8017709255015



Esthetiek



Esthetiek
Kleur
Afwerking
Materiaal
Type glas
Glazen rand
Type bediening
Slider
Slider
Positie bediening
Kleur serigrafie

Universeel
Zwart
Glas
Glas
Keramisch
Facetrand voor
Multi Slider
Ja
Red
Voor
Grijs

Programma's / functies



Totaal aantal kookzones
Aantal inductiekookzones
Aantal kookzones met booster
Hoofdtoets aan/uit
Vermogenniveaus
Auto-Vent

4
4
4
Ja
14
Ja

Opties



Worktop Cut-Out	490x560 mm	ECO-Logic optie	Ja, Advance
Automatische uitschakeling	4	ECO-Logic optie - stappen	1500, 2000, 2500, 3000, 3500, 4000, 4500, 5000, 6000, 7200 W
Pauze optie	Ja	Showroom demo optie	Ja
Timer	4	Kinderbeveiliging	Ja
Akoestisch signaal einde kooktijd	Ja	Snelle selectie niveaus	Ja
Resttijd indicator	Ja		

Technische specificaties



Linksvoor - Inductie - enkel - 2.30 kW - Booster 3.70 kW - Ø 21 cm
 Linksachter - Inductie - enkel - 1.80 kW - Booster 2.80 kW - Ø 18 cm
 Rechtsvoor - Inductie - enkel - 1.80 kW - Booster 2.80 kW - Ø 18 cm
 Rechtsachter - Inductie - enkel - 1.40 kW - Booster 2.50 kW - Ø 14.5 cm

Automatische herkenning panafmeting	Ja	Automatisch uitschakelen i.g.v. overkoken	Ja
Automatische panherkenning	Ja	Eco-Heat	Ja
Indicator minimaal te gebruiken diameter	Ja	Eco-Off	Ja
Automatische stop bij oververhitting	Ja		

Elektrische aansluiting

Aansluitwaarde	7200 W	Frequentie	50/60 Hz
Spanning (V)	220-240 V	Lengte voedingskabel	150 cm
Spanning 2 (V)	400 V	Connection box	5 polig
Type stroomkabel	Universeel		

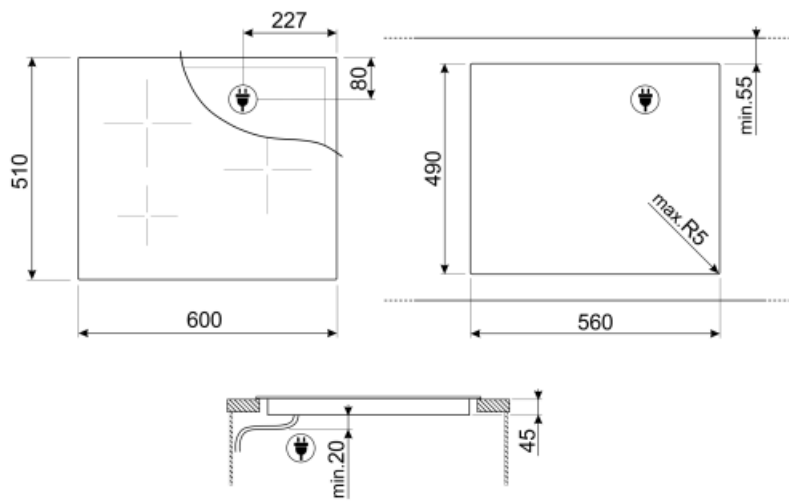

Accessoires niet inbegrepen



GRILLPLATE

Universal griddle for induction, gas, ceramic and electric hobs. Non-stick surface ideal for cooking meat, cheese and vegetables. Dimensions: 410 x 240 mm.



TPK

Roestvrijstalen grillplaat om Teppanyaki-gerechten te bereiden



TPKPLATE

Universal plate for induction, gas, ceramic and electric hobs. Non-stick surface ideal for cooking fish, eggs and vegetables. Dimensions: 410 X 240 mm.



SCRIP

















Inductie- en keramische kookplaten en teppanyaki-schraper



LGCN

Connecting Strip Built-in hobs, stainless steel, 475/495 mm

Symbols glossary (TT)

 <p>Een slim infrarood systeem, waardoor een afzuigkap en kookplaat met deze functie samenwerken.</p>	 <p>Powerbooster: optie zorgt ervoor dat de zone op vol vermogen werkt wanneer zeer intensief koken nodig is.</p>
 <p>Ultra-low profile: Installation of product with flat edge - height of 1 mm.</p>	 <p>Kinderslot: sommige modellen zijn voorzien van een apparaat om het programma / de cyclus te vergrendelen zodat het niet kan per ongeluk veranderd</p>
 <p>The slider control panel allows you to adjust the power simply by passing your finger across the touch device.</p>	 <p>Premium individual Slider control for each zone</p>
 <p>Eco-Heat: deze functie waarschuwt wanneer de zone na het uitschakelen nog warm is. Dit zorgt niet alleen voor maximale veiligheid door brandwonden te voorkomen, maar ook om de restwarmte te gebruiken om door te koken of om voedsel warm te houden.</p>	 <p>Eco-Off: deze energiebesparende functie schakelt de zone uit voordat de timer klinkt, gebruikmakend van de restwarmte in de pan</p>
 <p>Overheat protection: The safety system that automatically turns off the hob in case of overheating of the control unit.</p>	 <p>Induction: The work of these hobs is based on the principle of electromagnetic induction. The heat is generated directly in the bottom of the pan during its contact with the hob.</p>
 <p>Overfill protection: The special overflow protection shuts down the stove in the presence of overflow of liquids.</p>	 <p>All cooking zones can be reduced to the minimum power level, so the hob can be left unattended for a short period without food overcooking or burning. Then just press again this function, the previously set power levels can be reactivated.</p>
 <p>Quick selection, with one touch cooking begins at the highest level, then automatically reduces after time. Ideal for dishes that require quick boiling and then continued cooking without constant control (eg beef broth).</p>	 <p>Time elapsed: shows how long the cooking zone has been in use.</p>
 <p>Timer: All ceramic hobs have a timer which automatically ends cooking after a preset time.</p>	 <p>Possibility to set the maximum power absorption of the hob</p>