

# SI7844B

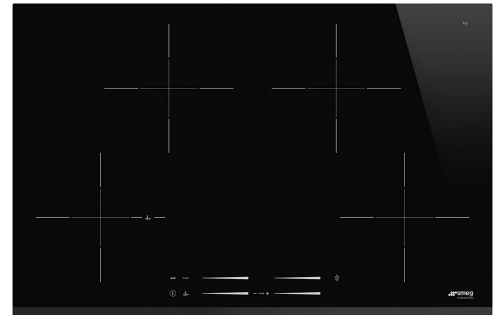

<b>Product Family</b>	Hob
<b>Built-in type</b>	Ultra-low profile
<b>Dimensions</b>	78 cm
<b>Power supply</b>	Electric
<b>Type</b>	Induction
<b>EAN code</b>	8017709254933



## Aesthetics



<b>Aesthetic</b>	Universale
<b>Colour</b>	Black
<b>Finishing</b>	Glass
<b>Material</b>	Glass
<b>Glass type</b>	Ceramic
<b>Glass edge</b>	Bevelled Front Edge
<b>Type of control setting</b>	Multi Slider
<b>Slider</b>	Yes
<b>LED colours</b>	Red
<b>Control knob position</b>	Front
<b>Serigraphy colour</b>	Grey

## Programme / Functions



<b>Total no. of cook zones</b>	4
<b>No. of induction cook zones</b>	4
<b>No. of cooking zones with booster</b>	4
<b>Main on/off switch</b>	Yes
<b>Power levels</b>	14
<b>Auto-Vent</b>	Yes

## Options



<b>Worktop Cut-Out</b>	490x750-780 mm
<b>End cooking timer</b>	4
<b>Pause option</b>	Yes
<b>Minute minder</b>	4
<b>End of cooking alarm</b>	Yes
<b>Residual time indicator</b>	Yes

<b>Limited Power Consumption Mode</b>	Si Advance
<b>Limited Power Consumption Mode in W</b>	1500, 2000, 2500, 3000, 3500, 4000, 4500, 5000, 6000, 7200 W
<b>Showroom Demo Option</b>	Yes
<b>Control Lock / Child Safety</b>	Yes
<b>Rapid level selection</b>	Yes

## Technical Features



Front-left - Induction - Single - 2.30 kW - Booster 3.20 kW - Ø 21 cm  
 Rear-left - Induction - Single - 2.30 kW - Booster 3.20 kW - Ø 21 cm  
 Front-right - Induction - Single - 2.30 kW - Booster 3.20 kW - Ø 21 cm  
 Rear-right - Induction - Single - 2.30 kW - Booster 3.20 kW - Ø 21 cm

<b>Automatic setting according to pan dimension</b>	Yes	<b>Automatic switch off when overflow</b>	Yes
<b>pan detection</b>	Yes	<b>Perfect Heat Sensor</b>	Yes
<b>Minimum pan diameter indication</b>	Yes	<b>Eco-Heat</b>	Yes
<b>Automatic switch off when overheat</b>	Yes	<b>Eco-Off</b>	Yes

## Electrical Connection

<b>Plug</b>	Not present	<b>Type of electric cable installed</b>	Universal
<b>Electrical connection rating (W)</b>	7200 W	<b>Frequency (Hz)</b>	50/60 Hz
<b>Voltage (V)</b>	220-240 V	<b>Power supply cable length</b>	150 cm
<b>Voltage 2 (V)</b>	400 V	<b>Terminal box</b>	5 poles

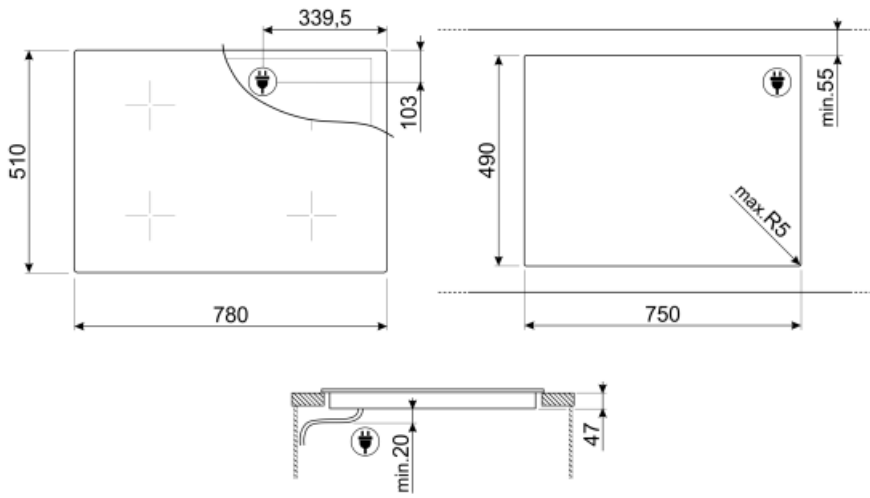

---

## Not included accessories

---



### GRILLPLATE

Universal griddle for induction, gas, ceramic and electric hobs. Non-stick surface ideal for cooking meat, cheese and vegetables. Dimensions: 410 x 240 mm.



### TPK

Stainless steel grill plate to cook Teppanyaki dishes



### TPKPLATE

Universal plate for induction, gas, ceramic and electric hobs. Non-stick surface ideal for cooking fish, eggs and vegetables. Dimensions: 410 X 240 mm.



### SCRIP



















Non-scratch hob scraper - suitable for induction and ceramic hobs



### LGCN

Connecting Strip Built-in hobs, stainless steel, 475/495 mm

## Symbols glossary (TT)

 <p>A smart infrared system, which allows a hood and hob with this feature to work together.</p>	 <p>Power booster: option allows the zone to work at full power when very intense cooking is necessary.</p>
 <p>Ultra-low profile: Installation of product with flat edge - height of 1 mm.</p>	 <p>Child lock: some models are fitted with a device to lock the programme/cycle so it cannot be accidentally changed.</p>
 <p>Premium individual Slider control for each zone</p>	 <p>The slider control panel allows you to adjust the power simply by passing your finger across the touch device.</p>
 <p>Eco-Heat: this function warns when the zone is still hot after being switched off. As well as ensuring maximum safety by preventing burns, this also allows you to make use of residual heat to continue cooking or keep foods hot.</p>	 <p>Eco-Off: This energy-saving function shuts the zone down before the timer sounds, making use of the residual heat in the pan.</p>
 <p>Overheat protection: The safety system that automatically turns off the hob in case of overheating of the control unit.</p>	 <p>Induction: The work of these hobs is based on the principle of electromagnetic induction. The heat is generated directly in the bottom of the pan during its contact with the hob.</p>
 <p>Overfill protection: The special overfill protection shuts down the stove in the presence of overflow of liquids.</p>	 <p>All cooking zones can be reduced to the minimum power level, so the hob can be left unattended for a short period without food overcooking or burning. Then just press again this function, the previously set power levels can be reactivated.</p>
 <p>This function allows you to keep the temperature of the pan constant during cooking without having to manually adjust the power level on the hob. Ideal for keeping food warm, but also for keeping temperatures constant during more intensive cooking, particularly frying.</p>	 <p>Quick selection, with one touch cooking begins at the highest level, then automatically reduces after time. Ideal for dishes that require quick boiling and then continued cooking without constant control (eg beef broth).</p>
 <p>Time elapsed: shows how long the cooking zone has been in use.</p>	 <p>Timer: All ceramic hobs have a timer which automatically ends cooking after a preset time.</p>
 <p>Possibility to set the maximum power absorption of the hob</p>	 <p>Perfect fit in a 80 cm cabinet</p>