

# SIA1963DG



Familie	Kookplaat
Inbouw	Vlak opbouw of vlak inbouw
Afmeting	90 cm
Voeding	Elektrisch
Type	Inductie
EAN-code	8017709328016



## Design



Esthetiek	Linea
Kleur	Neptune Grey
Afwerking	Glas
Materiaal	Glas
Type glas	'Glassy' ceramic
Glazen rand	Rechte rand
Type bediening	Vivo Screen Max
Slider	Ja
Slider	TFT
Positie bediening	Voor
Logo	Geëtst
Kleur serigrafie	Zwart
Andere beschikbare kleuren	Zwart

## Program / Functions



Aantal inductiekookzones	6
Opties tijdprogrammering	Automatische uitschakeling
Aantal kookzones met booster	6
Aantal Multizones	3
Hoofdtoets aan/uit	Ja
Vermogenniveaus	17

## Opties



<b>Multizone optie</b>	Ja	<b>Timer</b>	1
<b>Flexible Zone Type</b>	AreaZone	<b>Akoestisch signaal einde kooktijd</b>	Ja
<b>Worktop Cut-Out</b>	500-916 mm	<b>Resttijd indicator</b>	Ja
<b>Multizone optie</b>	Ja	<b>ECO-Logic optie</b>	Ja, Advance
<b>Functie automatisch koken</b>	Ja	<b>ECO-Logic optie - stappen</b>	2400 a 11100 - step 100 W
<b>Sudderfunctie</b>	Ja	<b>Showroom demo optie</b>	Ja
<b>Warmhoudfunctie</b>	Ja	<b>Kinderbeveiliging</b>	Ja
<b>Smelt/ Lage temperatuurfunctie</b>	Ja	<b>TwinZone optie</b>	Ja
<b>Automatische uitschakeling</b>	6	<b>Quick start</b>	Ja
<b>Pauze optie</b>	Ja	<b>Snelle selectie niveaus</b>	Ja

## Technische specificaties

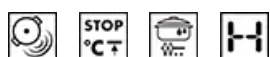

Midden - Inductie - Multizone - 2.40 kW - Booster 3.70 kW - 84.0x40.0 cm

<b>Automatische herkenning panafmeting</b>	Ja	<b>Automatisch uitschakelen i.g.v. overkoken</b>	Ja
<b>Automatische panherkenning</b>	minimaal 10 cm	<b>Restwarmte indicator</b>	Ja
<b>Permanente automatische pandetectie met indicatie van de relatieve controle</b>	Ja	<b>beveiliging tegen onbedoeld inschakeling</b>	Ja
<b>Automatische stop bij oververhitting</b>	Ja		

## Elektrische aansluiting

<b>Aansluitwaarde</b>	11100 W	<b>Type of electric cable supplied</b>	Yes, Single and Double phase
<b>Stroom</b>	49 A	<b>Frequentie</b>	50/60 Hz
<b>Spanning (V)</b>	220-240 V	<b>Lengte voedingskabel</b>	120 cm
<b>Spanning 2 (V)</b>	380-415 V	<b>Connection box</b>	5 polig
<b>Type stroomkabel</b>	Driefasig	<b>Stekker</b>	Nee
<b>Type stroomkabel</b>	Enkele en dubbele fase		



---

## Compatibele Accessoires

---



### GRILLPLATE

Universal griddle for induction, gas, ceramic and electric hobs. Non-stick surface ideal for cooking meat, cheese and vegetables. Dimensions: 410 x 240 mm.



### TPKPLATE

Universal plate for induction, gas, ceramic and electric hobs. Non-stick surface ideal for cooking fish, eggs and vegetables. Dimensions: 410 X 240 mm.



### SCRP

Inductie- en keramische kookplaten en teppanyaki-schraper

---

## Alternative products























---

SIA1963D

Kleur: Zwart



## Symbols glossary

 <p>Automatic Boiling function: a sensor confirms once the boiling point has been reached and then an acoustic alert signals that the ingredients can be added, saving time and energy.</p>	 <p>Powerbooster: optie zorgt ervoor dat de zone op vol vermogen werkt wanneer zeer intensief koken nodig is.</p>
 <p>Kinderslot: sommige modellen zijn voorzien van een apparaat om het programma / de cyclus te vergrendelen zodat het niet kan per ongeluk veranderd</p>	 <p>The slider control panel allows you to adjust the power simply by passing your finger across the touch device.</p>
 <p>This function allows you to keep cooked food warm without burner it</p>	 <p>Overheat protection: The safety system that automatically turns off the hob in case of overheating of the control unit.</p>
 <p>Induction: The work of these hobs is based on the principle of electromagnetic induction. The heat is generated directly in the bottom of the pan during its contact with the hob.</p>	 <p>Melting function, suitable for slowly melting delicate foods such as chocolate or butter.</p>
 <p>Overfill protection: The special overfill protection shuts down the stove in the presence of overflow of liquids.</p>	 <p>All cooking zones can be reduced to the minimum power level, so the hob can be left unattended for a short period without food overcooking or burning. Then just press again this function, the previously set power levels can be reactivated.</p>
 <p>Quick selection, with one touch cooking begins at the highest level, then automatically reduces after time. Ideal for dishes that require quick boiling and then continued cooking without constant control (eg beef broth).</p>	 <p>Quick Start function: the chosen temperature is reached faster. The heating element works at maximum power until the right temperature is reached.</p>
 <p>Indication of residual heat: After the glass ceramic hob is switched off the residual heat indicator shows which of the heating zones still remains hot. When the temperature drops below 60 ° C, the indicator goes out.</p>	 <p>Simmering function: ideal for long-cooking recipes, preventing food from boiling over or sticking to the pan.</p>
 <p>Time elapsed: shows how long the cooking zone has been in use.</p>	 <p>Timer: All ceramic hobs have a timer which automatically ends cooking after a preset time.</p>
 <p>TWIN_ZONE_72dpi</p>	 <p>Permanent auto pot detection</p>
 <p>Possibility to set the maximum power absorption of the hob.</p>	 <p>Possibility to freely move the pot everywhere without turn off the initial settings chosen.</p>
 <p>7 inches TFT touch, high resolution display, true colours</p>	 <p>Elegant silver or black glass with under glass serigraphy which allows smoothness, brilliance and no noise to the surface</p>