

SIA1963DS

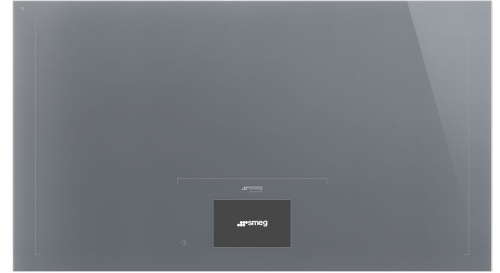

Product Family	Hob
Built-in type	Ultra-low profile or Fully Flushed
Dimensions	90 cm
Power supply	Electric
Type	Induction
EAN code	8017709304041



Aesthetics



Aesthetic	Linea
Colour	Silver
Finishing	Glass
Material	Glass
Glass type	'Glassy' ceramic
Glass edge	Straight edge
Type of control setting	Vivo Screen Max
Slider	Yes
Slider	TFT
Control knob position	Front
Serigraphy colour	Grey
Alternative colours available	Black

Options



Multizone Option	Yes	Minute minder	1
Flexible Zone Type	AreaZone	End of cooking alarm	Yes
Standard cut out	500-916 mm	Residual time indicator	Yes
Multizone Option	Yes	Limited Power Consumption Mode	Advanced Eco Logic
Auto-boiling Function	Yes	Limited Power Consumption Mode in W	2400 a 11100 - step 100 W
Simmering Function	Yes	Showroom Demo Option	Yes
Keep warm automatic function	Yes	Control Lock / Child Safety	Yes

Melting/Low temperature cooking function	Yes	Bridge option	Yes
End cooking timer	6	Quick start	Yes
Pause option	Yes	Rapid level selection	Yes

Technical Features



Central - Induction - Multizone - 2.40 kW - Booster 3.70 kW - 84.0x40.0 cm

Automatic setting according to pan dimension	Yes	Automatic switch off when overflow	Yes
pan detection	Si, min 10 cm	Residual heat indicator	Yes
Permanent Automatic Pot Detection with indication of the relative control	Yes	Protection against accidental start up	Yes
Automatic switch off when overheat	Yes		

Electrical Connection

Electrical connection rating (W)	11100 W	Type of electric cable	Single and Double phase
Current	49 A	Type of electric cable supplied	Yes, Single and Double phase
Voltage (V)	220-240 V	Frequency (Hz)	50/60 Hz
Voltage 2 (V)	380-415 V	Power supply cable length	120 cm
Type of electric cable	Three-phase	Terminal box	5 poles

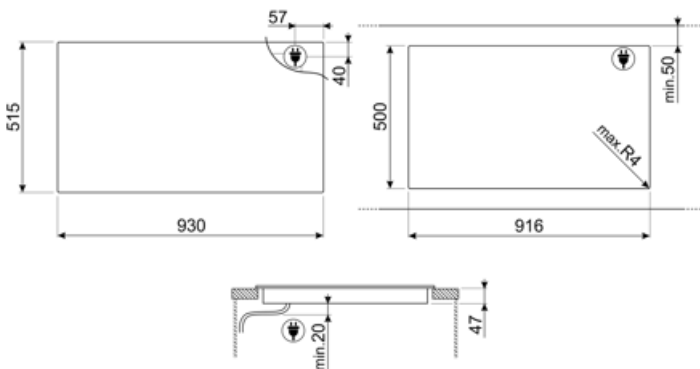

Not included accessories



GRILLPLATE

Universal griddle for induction, gas, ceramic and electric hobs. Non-stick surface ideal for cooking meat, cheese and vegetables. Dimensions: 410 x 240 mm.



SCRP

Induction and ceramic hobs and teppanyaki scraper



TPK















Stainless steel grill plate to cook Teppanyaki dishes



TPKPLATE

Universal plate for induction, gas, ceramic and electric hobs. Non-stick surface ideal for cooking fish, eggs and vegetables. Dimensions: 410 X 240 mm.

Symbols glossary (TT)

	Automatic merge of zones for a bigger area		...
	Automatic Boiling function: a sensor confirms once the boiling point has been reached and then an acoustic alert signals that the ingredients can be added, saving time and energy.		Power booster: option allows the zone to work at full power when very intense cooking is necessary.
	Child lock: some models are fitted with a device to lock the programme/cycle so it cannot be accidentally changed.		The slider control panel allows you to adjust the power simply by passing your finger across the touch device.
	Keep warm function: Keep warm function keeps the cooked food heated. In this mode the heating zone operates at a minimum capacity for 120 minutes and then turns off automatically.		Overheat protection: The safety system that automatically turns off the hob in case of overheating of the control unit.
	Induction: The work of these hobs is based on the principle of electromagnetic induction. The heat is generated directly in the bottom of the pan during its contact with the hob.		Melting function, suitable for slowly melting delicate foods such as chocolate or butter.
	Overfill protection: The special overfill protection shuts down the stove in the presence of overflow of liquids.		PAUSE_72dpi
	Quick selection, with one touch cooking begins at the highest level, then automatically reduces after time. Ideal for dishes that require quick boiling and then continued cooking without constant control (eg beef broth).		Quick Start function: the chosen temperature is reached faster. The heating element works at maximum power until the right temperature is reached.
	Indication of residual heat: After the glass ceramic hob is switched off the residual heat indicator shows which of the heating zones still remains hot. When the temperature drops below 60 ° C, the indicator goes out.		Simmering function: ideal for long-cooking recipes, preventing food from boiling over or sticking to the pan.
	Time elapsed: shows how long the cooking zone has been in use.		Timer: All ceramic hobs have a timer which automatically ends cooking after a preset time.
	TWIN_ZONE_72dpi		...
	7 inches TFT touch, high resolution display, true colours		Elegant silver or black glass with under glass serigraphy which allows smoothness, brilliance and no noise to the surface