

# SIM1844DS



<b>Product Family</b>	Hob
<b>Built-in type</b>	Ultra-low profile or Fully Flushed
<b>Dimensions</b>	80 cm
<b>Power supply</b>	Electric
<b>Type</b>	Induction
<b>EAN code</b>	8017709309718



## Aesthetics



<b>Aesthetic</b>	Linea
<b>Colour</b>	Silver
<b>Finishing</b>	Glass
<b>Material</b>	Glass
<b>Glass type</b>	'Glassy' ceramic
<b>Glass edge</b>	Straight edge
<b>Type of control setting</b>	Multi Slider
<b>Slider</b>	Yes
<b>LED colours</b>	White
<b>Control knob position</b>	Front
<b>Logo</b>	Silk screen
<b>Serigraphy colour</b>	Grey
<b>Alternative colours available</b>	Black

## Program / Functions



<b>No. of induction cook zones</b>	4
<b>Time-setting options</b>	Automatic switch-off
<b>No. of cooking zones with booster</b>	4
<b>No. of Flexible zones</b>	1
<b>Main on/off switch</b>	Yes
<b>Power levels</b>	9
<b>Auto-vent 2.0</b>	Yes
<b>Total no. of cook zones</b>	4

## Options

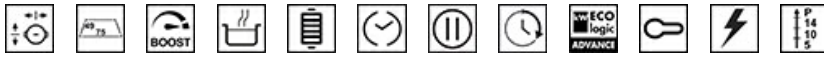

<b>Multizone Option</b>	Yes	<b>End of cooking alarm</b>	Yes
<b>Flexible Zone Type</b>	MultiZone	<b>Residual time indicator</b>	Yes
<b>Worktop Cut-Out</b>	490x750-780 mm	<b>Limited Power</b>	Si Advance
<b>Double Booster</b>	Yes	<b>Consumption Mode</b>	
<b>Keep warm automatic function</b>	Yes	<b>Limited Power Consumption Mode in W</b>	2400 a 7400 - step 100 W
<b>Grill function</b>	Yes	<b>Showroom Demo Option</b>	Yes
<b>End cooking timer</b>	4	<b>Control Lock / Child Safety</b>	Yes
<b>Pause option</b>	Yes	<b>Bridge option</b>	si-AUTO
<b>Minute minder</b>	1	<b>Quick start</b>	Yes
		<b>Rapid level selection</b>	Yes

## Technical Features



Centre-left - Induction - Single - 2.30 kW - Booster 3.00 kW - Double booster 3 kW - Ø 25.0 cm  
 Front-centre - Induction - Single - 1.40 kW - Booster 2.10 kW - Double booster 3 kW - Ø 16.0 cm  
 Rear-right - Induction - Multizone - 2.10 kW - Booster 2.50 kW - Double booster 3 kW - 22.0x18.0 cm  
 Front-right - Induction - Multizone - 2.10 kW - Booster 2.50 kW - Double booster 3 kW - 22.0x18.0 cm

38.5x23.0 cm

38.5x23.0 cm

<b>Automatic setting according to pan dimension</b>	Yes	<b>Automatic switch off when overflow</b>	Yes
<b>pan detection</b>	Yes, min. 7 cm	<b>Residual heat indicator</b>	Yes
<b>Permanent Automatic Pot Detection with indication of the relative control</b>	Yes	<b>Protection against accidental start up</b>	Yes
<b>Automatic switch off when overheat</b>	Yes		

## Electrical Connection

<b>Electrical connection rating (W)</b>	7400 W	<b>Additional connection modalities</b>	Yes, Double and Three Phase
<b>Current</b>	33 A	<b>Frequency (Hz)</b>	50/60 Hz
<b>Voltage (V)</b>	220-240 V	<b>Power supply cable length</b>	120 cm
<b>Voltage 2 (V)</b>	380-415 V	<b>Terminal box</b>	5 poles
<b>Type of electric cable installed</b>	Yes, Single phase	<b>Plug</b>	Not present



---

## Compatible Accessories

---



### GRILLPLATE

Universal griddle for induction, gas, ceramic and electric hobs. Non-stick surface ideal for cooking meat, cheese and vegetables. Dimensions: 410 x 240 mm.



### TPKPLATE























Universal plate for induction, gas, ceramic and electric hobs. Non-stick surface ideal for cooking fish, eggs and vegetables. Dimensions: 410 X 240 mm.



### SCRP

Non-scratch hob scraper - suitable for induction and ceramic hobs

## Symbols glossary

	Permanent auto pot detection		Connection between hob and hood
	Power booster: option allows the zone to work at full power when very intense cooking is necessary.		Child lock: some models are fitted with a device to lock the programme/cycle so it cannot be accidentally changed.
	The slider control panel allows you to adjust the power simply by passing your finger across the touch device.		This function allows you to keep cooked food warm without burner it
	Overheat protection: The safety system that automatically turns off the hob in case of overheating of the control unit.		Induction: The work of these hobs is based on the principle of electromagnetic induction. The heat is generated directly in the bottom of the pan during its contact with the hob.
	Multizone: allows several pans to be used at once, large or small, offering freedom of placement and greater flexibility		Overfill protection: The special overfill protection shuts down the stove in the presence of overflow of liquids.
	All cooking zones can be reduced to the minimum power level, so the hob can be left unattended for a short period without food overcooking or burning. Then just press again this function, the previously set power levels can be reactivated.		Quick selection, with one touch cooking begins at the highest level, then automatically reduces after time. Ideal for dishes that require quick boiling and then continued cooking without constant control (eg beef broth).
	Quick Start function: the chosen temperature is reached faster. The heating element works at maximum power until the right temperature is reached.		Indication of residual heat: After the glass ceramic hob is switched off the residual heat indicator shows which of the heating zones still remains hot. When the temperature drops below 60 ° C, the indicator goes out.
	Time elapsed: shows how long the cooking zone has been in use.		Timer: All ceramic hobs have a timer which automatically ends cooking after a preset time.
	Grill function		Min diameter pot detection of 7 cm.
	Possibility to set the maximum power absorption of the hob.		Perfect fit in a 80 cm cabinet
	Additional maximum power level for a better energy consumption		Premium individual Slider control for each zone
	Elegant silver or black glass with under glass serigraphy which allows smoothness, brilliance and no noise to the surface		