

SIM3844D

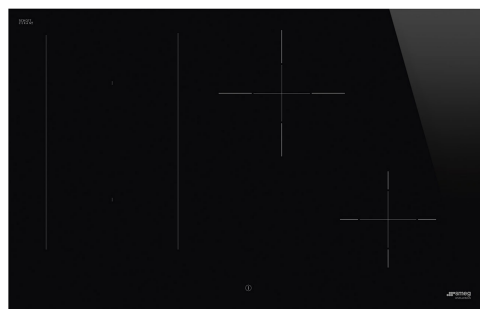

Familie	Kookplaat
Inbouw	Vlak opbouw of vlak inbouw
Afmeting	80 cm
Voeding	Elektrisch
Type	Inductie
EAN-code	8017709305574



Design



Esthetiek	Classici
Kleur	Zwart
Afwerking	Glas
Materiaal	Glas
Type glas	ceramic Eclipse
Glazen rand	Rechte rand
Type bediening	EVO Slider
Slider	Ja
Slider	Wit
Positie bediening	Voor
Kleur serigrafie	Grijs

Programma's / functies



Aantal inductiekookzones	4
Opties tijdprogrammering	Automatische uitschakeling
Aantal kookzones met booster	4
Aantal Multizones	1
Hoofdtoets aan/uit	Ja
Vermogenniveaus	9
Auto-vent 2.0	Ja
Totaal aantal kookzones	4

Opties



Multizone optie	Ja	Resttijd indicator	Ja
Flexible Zone Type	MultiZone	ECO-Logic optie	Ja, Advance
Worktop Cut-Out	480x730 mm	ECO-Logic optie - stappen	2400 a 7400 - step 100 W
Warmhoudfunctie	Ja	Showroom demo optie	Ja
Grill functie	Ja	Kinderbeveiliging	Ja
Automatische uitschakeling	4	TwinZone optie	Ja
Pauze optie	Ja	Quick start	Ja
Timer	1	Snelle selectie niveaus	Ja
Akoestisch signaal einde kooktijd	Ja		

Technische specificaties



Linksvoor - Inductie - Multizone - 2.10 kW - Booster 2.50 kW - Double booster 3.00 kW - 24.0x18.0 cm
 Linksachter - Inductie - Multizone - 2.10 kW - Booster 2.50 kW - Double booster 3.00 kW - 24.0x18.0 cm
 Midden - Inductie - enkel - 2.30 kW - Booster 3.00 kW - Double booster 3.00 kW - Ø 21.0 cm
 Rechtsvoor - Inductie - enkel - 1.40 kW - Booster 2.10 kW - Ø 16.0 cm
 Multizone left - Booster 3.70 kW - 38.5x23.0 cm

Automatische herkenning panafmeting	Ja	Automatische stop bij oververhitting	Ja
Automatische panherkenning	minimaal 7 cm	Automatisch uitschakelen i.g.v. overkoken	Ja
Permanente automatische pandetectie met indicatie van de relatieve controle	Ja	Restwarmte indicator	Ja
Indicator minimaal te gebruiken diameter	Ja	beveiliging tegen onbedoeld inschakeling	Ja

Elektrische aansluiting

Aansluitwaarde	7400 W	Type stroomkabel	Yes, Double and Three Phase
Stroom	33 A	Type of electric cable supplied	Yes, Double and Three Phase
Spanning (V)	220-240 V	Frequentie	50/60 Hz
Spanning 2 (V)	380-415 V	Lengte voedingskabel	120 cm
Type stroomkabel	Eenfasig	Connection box	5 polig

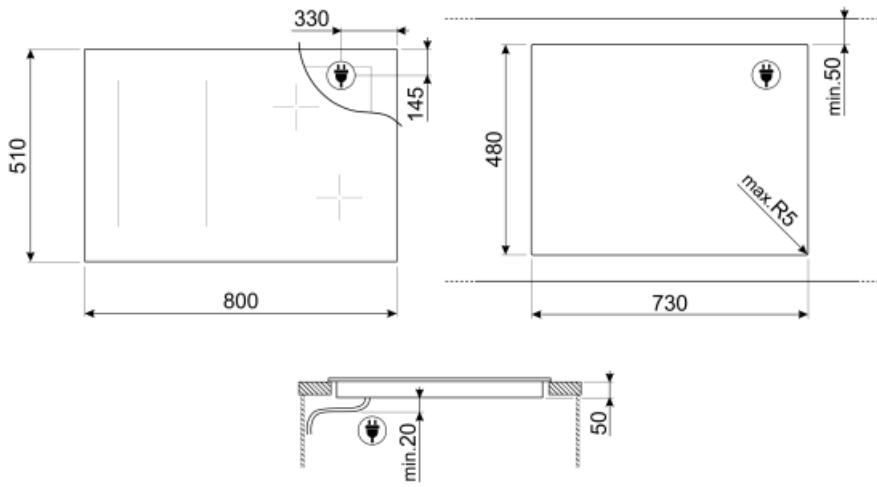

Accessoires niet inbegrepen



GRILLPLATE

Universal griddle for induction, gas, ceramic and electric hobs. Non-stick surface ideal for cooking meat, cheese and vegetables. Dimensions: 410 x 240 mm.



SCRP

Inductie- en keramische kookplaten en teppanyaki-schraper



TPK























Roestvrijstalen grillplaat om Teppanyaki-gerechten te bereiden



TPKPLATE

Universal plate for induction, gas, ceramic and electric hobs. Non-stick surface ideal for cooking fish, eggs and vegetables. Dimensions: 410 X 240 mm.

Symbols glossary (TT)

	Permanent auto pot detection		Connection between hob and hood
	Powerbooster: optie zorgt ervoor dat de zone op vol vermogen werkt wanneer zeer intensief koken nodig is.		Kinderslot: sommige modellen zijn voorzien van een apparaat om het programma / de cyclus te vergrendelen zodat het niet kan per ongeluk veranderd
	Evolution Slider totally Back-lighted ghost effect		The slider control panel allows you to adjust the power simply by passing your finger across the touch device.
	This function allows you to keep cooked food warm without burner it		Overheat protection: The safety system that automatically turns off the hob in case of overheating of the control unit.
	Induction: The work of these hobs is based on the principle of electromagnetic induction. The heat is generated directly in the bottom of the pan during its contact with the hob.		Multizone: allows several pans to be used at once, large or small, offering freedom of placement and greater flexibility
	Overfill protection: The special overfill protection shuts down the stove in the presence of overflow of liquids.		All cooking zones can be reduced to the minimum power level, so the hob can be left unattended for a short period without food overcooking or burning. Then just press again this function, the previously set power levels can be reactivated.
	Quick selection, with one touch cooking begins at the highest level, then automatically reduces after time. Ideal for dishes that require quick boiling and then continued cooking without constant control (eg beef broth).		Quick Start function: the chosen temperature is reached faster. The heating element works at maximum power until the right temperature is reached.
	Indication of residual heat: After the glass ceramic hob is switched off the residual heat indicator shows which of the heating zones still remains hot. When the temperature drops below 60 ° C, the indicator goes out.		Time elapsed: shows how long the cooking zone has been in use.
	Timer: All ceramic hobs have a timer which automatically ends cooking after a preset time.		TWIN_ZONE_72dpi
	Grill function		Min diameter pot detection of 7 cm
	Possibility to set the maximum power absorbion of the hob		Darkness becomes light