

# SISL7845X



Product familie	Kookplaat
Type	Tussenbouw
Afmeting	80 cm
Voeding	Elektrisch
Type	Inductie
EAN-code	8017709357153



## Design

Design	Isola
Serie	Alta Pro
Kleur	Black with stainless steel effect frame
Perimeter lighting	Yes
Afwerking	Glas
Materiaal	Glas
Type glas	Prestige ceramic
Glazen rand	Rechte rand
Kader	Ja
Kleur kader	Inox
Frame material	Aluminum
Bediening	Vivo Screen
Kleur LED	Touch display
Positie bediening	Vooraan
Logo	Geëts
Kleur serigrafie	Grijs
Andere beschikbare kleuren	Zwart

## Program / Functions



Aantal inductiekookzones	4
Opties tijdprogrammering	Automatische uitschakeling
Aantal kookzones met booster	4
Aantal Multizones	1
Hoofdtoets aan/uit	Ja
Vermogenniveaus	17

Totaal aantal kookzones

4

## Opties



<b>Multizone</b>	Ja	<b>Automatische uitschakeling</b>	4
<b>Flexible Zone Type</b>	MultiZone	<b>Pauze optie</b>	Ja
<b>Worktop Cut-Out</b>	480x730 mm	<b>Timer</b>	1
<b>Auto Multizone</b>	Ja	<b>Geluidssignaal einde kooktijd</b>	Ja
<b>Auto Multizone</b>	Ja	<b>Resttijd indicator</b>	Ja
<b>Pasta function</b>	Yes	<b>ECO-Logic optie</b>	Si Advance
<b>Steaming function</b>	Yes	<b>Beperkt vermogensverbruik</b>	2400 a 7400 - step 100 W
<b>Roasting function</b>	Yes	<b>Showroom demo optie</b>	Ja
<b>Water koken</b>	Ja	<b>Kinderbeveiliging</b>	Ja
<b>Suddereren</b>	Ja	<b>Quick start</b>	Ja
<b>Warmhoudfunctie</b>	Ja	<b>Snelle selectie niveaus</b>	Ja
<b>Smelten/Koken op lage temperatuur</b>	Ja		

## Technische specificaties



Linksvoor - Inductie - Multizone - 2.10 kW - Booster 3.00 kW - Double booster 3.70 kW - 21.0x0.0 cm  
 Linksachter - Inductie - Multizone - 2.10 kW - Booster 3.00 kW - Double booster 3.70 kW - 21.0x0.0 cm  
 Midden - Inductie - enkel - 1.40 kW - Booster 1.85 kW - Double booster 2.20 kW - Ø 14.5 cm  
 Rechtsvoor - Inductie - enkel - 2.60 kW - Booster 3.20 kW - Double booster 3.70 kW - Ø 26.0 cm  
 Multizone left - Booster 3.70 kW - 38.5x23.0 cm

<b>Automatische aanpassing panafmeting</b>	Ja	<b>Automatisch uitschakelen i.g.v. oververhitting</b>	Ja
<b>Automatische panherkenning</b>	Ja, min. 9 cm	<b>Automatisch uitschakelen i.g.v. overkoken</b>	Ja
<b>Permanente automatische pot herkenning met indicatie op de bediening</b>	Ja	<b>Restwarmte indicator</b>	Ja
<b>Indicator minimaal te gebruiken diameter</b>	Ja	<b>Beveiliging tegen accidentele inschakeling</b>	Ja

## Elektrische aansluiting

<b>Nominale aansluitwaarde</b>	7400 W	<b>Type of electric cable supplied</b>	Yes, Double and Three Phase
<b>Stroom</b>	33 A	<b>Frequentie</b>	50/60 Hz
<b>Spanning (V)</b>	220-240 V	<b>Lengte voedingskabel</b>	120 cm
<b>Spanning 2 (V)</b>	380-415 V	<b>Aansluiting</b>	5 polig
<b>Type stroomkabel</b>	Eenfasig	<b>Stekker</b>	Nee
<b>Type stroomkabel</b>	Yes, Double and Three Phase		

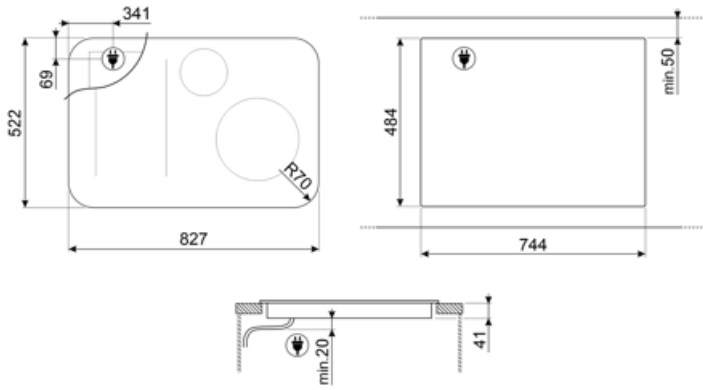

---

## Compatible Accessories

---



### GRILLPLATE

Universal griddle for induction, gas, ceramic and electric hobs. Non-stick surface ideal for cooking meat, cheese and vegetables. Dimensions: 410 x 240 mm.



### TPKPLATE

Universal plate for induction, gas, ceramic and electric hobs. Non-stick surface ideal for cooking fish, eggs and vegetables. Dimensions: 410 X 240 mm.



### SCRP

Schraper voor inductie- en vitrokeramische kookplaten

---

## Alternative products





















---

**SISL7845MB**

**Kleur:** Black with matt black frame



## Symbols glossary

 <p>Permanent auto pot detection</p>	 <p>Automatic Boiling function: a sensor confirms once the boiling point has been reached and then an acoustic alert signals that the ingredients can be added, saving time and energy.</p>
 <p>Power booster: option allows the zone to work at full power when very intense cooking is necessary.</p>	 <p>Sommige modellen zijn voorzien van een functie om het programma/de cyclus te blokkeren zodat het niet per ongeluk kan aangepast worden.</p>
 <p>This function allows you to keep cooked food warm without burner it</p>	 <p>Overheat protection: The safety system that automatically turns off the hob in case of overheating of the control unit.</p>
 <p>Induction: The work of these hobs is based on the principle of electromagnetic induction. The heat is generated directly in the bottom of the pan during its contact with the hob.</p>	 <p>Melting function, suitable for slowly melting delicate foods such as chocolate or butter.</p>
 <p>Multizone: maakt het mogelijk meerdere pannen tegelijk te gebruiken, groot of klein, voor meer plaatsingsvrijheid en meer flexibiliteit</p>	 <p>Overfill protection: The special overflow protection shuts down the stove in the presence of overflow of liquids.</p>
 <p>All cooking zones can be reduced to the minimum power level, so the hob can be left unattended for a short period without food overcooking or burning. Then just press again this function, the previously set power levels can be reactivated.</p>	 <p>Quick selection, with one touch cooking begins at the highest level, then automatically reduces after time. Ideal for dishes that require quick boiling and then continued cooking without constant control (eg beef broth).</p>
 <p>Quick Start function: the chosen temperature is reached faster. The heating element works at maximum power until the right temperature is reached.</p>	 <p>Indication of residual heat: After the glass ceramic hob is switched off the residual heat indicator shows which of the heating zones still remains hot. When the temperature drops below 60 ° C, the indicator goes out.</p>
 <p>Simmering function: ideal for long-cooking recipes, preventing food from boiling over or sticking to the pan.</p>	 <p>Time elapsed: shows how long the cooking zone has been in use.</p>
 <p>Timer: All ceramic hobs have a timer which automatically ends cooking after a preset time.</p>	 <p>Min diameter pot detection of 9 cm.</p>
 <p>Possibility to set the maximum power absorption of the hob.</p>	 <p>Additional maximum power level for a better energy consumption</p>
 <p>Possibility to freely move the pot everywhere without turn off the initial settings chosen.</p>	