

SISL7964

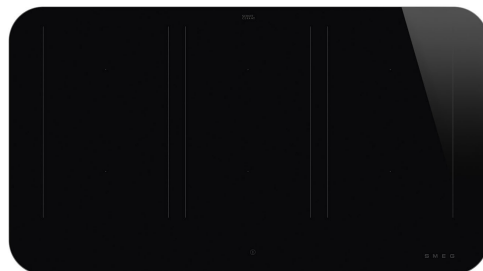

Product familie	Kookplaat
Type	Standaard opbouw of vlakbouw
Afmeting	90 cm
Voeding	Elektrisch
Type	Inductie
EAN-code	8017709351809



Design



Design	Isola
Serie	Flat
Kleur	Zwart
Afwerking	Glas
Materiaal	Glas
Type glas	Ceramic Eclipse
Glazen rand	Rechte rand
Bediening	EVO slider witte LED
Slider bediening	Ja
Kleur LED	Wit
Positie bediening	Vooraan
Logo	Geëtst
Kleur serigrafie	Grijs

Program / Functions



Aantal inductiekookzones	6
Opties tijdprogrammering	Automatische uitschakeling
Aantal kookzones met booster	6
Aantal Multizones	3
Hoofdtoets aan/uit	Ja
Vermogenniveaus	9
Auto-Vent 2.0	Ja
Totaal aantal kookzones	6

Opties



Multizone	Ja	Resttijd indicator	Ja
Flexible Zone Type	MultiZone	ECO-Logic optie	Si Advance
Worktop Cut-Out	490x860 mm	Beperkt vermogensverbruik	2400 a 11100 - step 100 W
Warmhoudfunctie	Ja	Showroom demo optie	Ja
Grill functie	Ja	Kinderbeveiliging	Ja
Automatische uitschakeling	6	TwinZone optie	Ja
Pauze optie	Ja	Quick start	Ja
Timer	1	Snelle selectie niveaus	Ja
Geluidssignaal einde kooktijd	Ja		

Technische specificaties



Linksvoor - Inductie - Multizone - 2.10 kW - Booster 2.50 kW - Double booster 3 kW - 24.0x18.0 cm
 Linksachter - Inductie - Multizone - 2.10 kW - Booster 2.50 kW - Double booster 3 kW - 24.0x18.0 cm
 Middenvoor - Inductie - Multizone - 2.10 kW - Booster 2.50 kW - Double booster 3 kW - 24.0x18.0 cm
 Middenachter - Inductie - Multizone - 2.10 kW - Booster 2.50 kW - Double booster 3 kW - 24.0x18.0 cm
 Rechtsvoor - Inductie - Multizone - 2.10 kW - Booster 2.50 kW - Double booster 3 kW - 24.0x18.0 cm
 Rechtsachter - Inductie - Multizone - 2.10 kW - Booster 2.50 kW - Double booster 3 kW - 24.0x18.0 cm
 Multizone left - Booster 3.7 kW - 38.5x23.0 cm
 Multizone center - Booster 3.7 kW - 38.5x23.0 cm
 Multizone right - Booster 3.7 kW - 38.5x23.0 cm

Automatische aanpassing panafmeting	Ja	Automatisch uitschakelen i.g.v. overkoken	Ja
Automatische panherkenning	Ja, min. 9 cm	Restwarmte indicator	Ja
Permanente automatische pot herkenning met indicatie op de bediening	Ja	Beveiliging tegen accidentele inschakeling	Ja
Automatisch uitschakelen i.g.v. oververhitting	Ja		

Elektrische aansluiting

Nominale aansluitwaarde	11100 W	Type of electric cable supplied	Yes, Single and Double phase
Stroom	49 A	Frequentie	50/60 Hz
Spanning (V)	220-240 V	Lengte voedingskabel	120 cm
Spanning 2 (V)	380-415 V	Aansluiting	5 polig
Type stroomkabel	Driefasig	Stekker	Neer

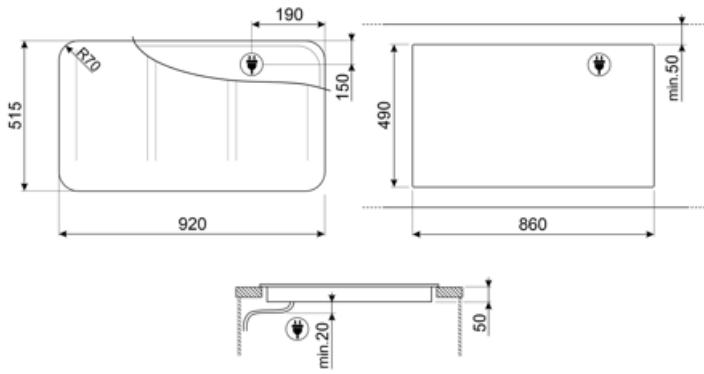

Compatible Accessories



GRILLPLATE

Universal griddle for induction, gas, ceramic and electric hobs. Non-stick surface ideal for cooking meat, cheese and vegetables. Dimensions: 410 x 240 mm.



SCRP























Schraper voor inductie- en vitrokeramische kookplaten



TPKPLATE

Universal plate for induction, gas, ceramic and electric hobs. Non-stick surface ideal for cooking fish, eggs and vegetables. Dimensions: 410 X 240 mm.

Symbols glossary

 <p>Power booster: option allows the zone to work at full power when very intense cooking is necessary.</p>	 <p>Sommige modellen zijn voorzien van een functie om het programma/de cyclus te blokkeren zodat het niet per ongeluk kan aangepast worden.</p>
 <p>The slider control panel allows you to adjust the power simply by passing your finger across the touch device.</p>	 <p>This function allows you to keep cooked food warm without burner it</p>
 <p>Overheat protection: The safety system that automatically turns off the hob in case of overheating of the control unit.</p>	 <p>Induction: The work of these hobs is based on the principle of electromagnetic induction. The heat is generated directly in the bottom of the pan during its contact with the hob.</p>
 <p>Multizone: maakt het mogelijk meerdere pannen tegelijk te gebruiken, groot of klein, voor meer plaatsingsvrijheid en meer flexibiliteit</p>	 <p>Overfill protection: The special overflow protection shuts down the stove in the presence of overflow of liquids.</p>
 <p>All cooking zones can be reduced to the minimum power level, so the hob can be left unattended for a short period without food overcooking or burning. Then just press again this function, the previously set power levels can be reactivated.</p>	 <p>Quick selection, with one touch cooking begins at the highest level, then automatically reduces after time. Ideal for dishes that require quick boiling and then continued cooking without constant control (eg beef broth).</p>
 <p>Quick Start function: the chosen temperature is reached faster. The heating element works at maximum power until the right temperature is reached.</p>	 <p>Indication of residual heat: After the glass ceramic hob is switched off the residual heat indicator shows which of the heating zones still remains hot. When the temperature drops below 60 ° C, the indicator goes out.</p>
 <p>Time elapsed: shows how long the cooking zone has been in use.</p>	 <p>Timer: All ceramic hobs have a timer which automatically ends cooking after a preset time.</p>
 <p>TWIN_ZONE_72dpi</p>	 <p>Permanent auto pot detection</p>
 <p>Connection between hob and hood</p>	 <p>Grill functie</p>
 <p>Min diameter pot detection of 9 cm.</p>	 <p>Possibility to set the maximum power absorption of the hob.</p>
 <p>Perfect fit in a 90 cm cabinet</p>	 <p>Darkness becomes light</p>
 <p>Evolution Slider totally Back-lighted ghost effect</p>	