

SISL7964MB



Familie	Kookplaat
Inbouw	Tussenbouw
Afmeting	90 cm
Voeding	Elektrisch
Type	Inductie
EAN-code	8017709351823



Design



Esthetiek	Isola
Serie	Alta
Kleur	Zwart
Afwerking	Glas
Materiaal	Glas
Type glas	ceramic Eclipse
Glazen rand	Rechte rand
Kader	Ja
Kleur kader	Zwart
Type bediening	EVO Slider
Slider	Ja
Slider	Wit
Positie bediening	Voor
Logo	Geëts
Kleur serigrafie	Grijs
Andere beschikbare kleuren	Roestvrij staal

Program / Functions



Aantal inductiekookzones	6
Opties tijdprogrammering	Automatische uitschakeling
Aantal kookzones met booster	6
Aantal Multizones	3
Hoofdtoets aan/uit	Ja

Vermogenniveaus	9
Auto-vent 2.0	Ja
Totaal aantal kookzones	6

Opties



Multizone optie	Ja	Resttijd indicator	Ja
Flexible Zone Type	MultiZone	ECO-Logic optie	Ja, Advance
Worktop Cut-Out	490x850 mm	ECO-Logic optie - stappen	2400 a 11100 - step 100 W
Warmhoudfunctie	Ja	Showroom demo optie	Ja
Grill functie	Ja	Kinderbeveiliging	Ja
Automatische uitschakeling	6	TwinZone optie	Ja
Pauze optie	Ja	Quick start	Ja
Timer	1	Snelle selectie niveaus	Ja
Akoestisch signaal einde kooktijd	Ja		

Technische specificaties



Linksvoor - Inductie - Multizone - 2.10 kW - Booster 2.50 kW - Double booster 3 kW - 24.0x18.0 cm
 Linksachter - Inductie - Multizone - 2.10 kW - Booster 2.50 kW - Double booster 3 kW - 24.0x18.0 cm
 Middenvoor - Inductie - Multizone - 2.10 kW - Booster 2.50 kW - Double booster 3 kW - 24.0x18.0 cm
 Middenachter - Inductie - Multizone - 2.10 kW - Booster 2.50 kW - Double booster 3 kW - 24.0x18.0 cm
 Rechtsvoor - Inductie - Multizone - 2.10 kW - Booster 2.50 kW - Double booster 3 kW - 24.0x18.0 cm
 Rechtsachter - Inductie - Multizone - 2.10 kW - Booster 2.50 kW - Double booster 3 kW - 24.0x18.0 cm
 Multizone left - Booster 3.7 kW - 38.5x23.0 cm
 Multizone center - Booster 3.7 kW - 38.5x23.0 cm
 Multizone right - Booster 3.7 kW - 38.5x23.0 cm

Automatische herkenning panafmeting	Ja	Automatisch uitschakelen i.g.v. overkoken	Ja
Automatische panherkenning	minimaal 9 cm	Restwarmte indicator	Ja
Permanente automatische pandetectie met indicatie van de relatieve controle	Ja	beveiliging tegen onbedoeld inschakeling	Ja
Automatische stop bij oververhitting	Ja		

Elektrische aansluiting

Aansluitwaarde	11100 W	Type of electric cable supplied	Yes, Single and Double phase
Stroom	49 A	Frequentie	50/60 Hz
Spanning (V)	220-240 V	Lengte voedingskabel	120 cm
Spanning 2 (V)	380-415 V		

Type stroomkabel
Type stroomkabel

Driefasig
Enkele en dubbele fase

Connection box
Stekker

5 polig
Nee

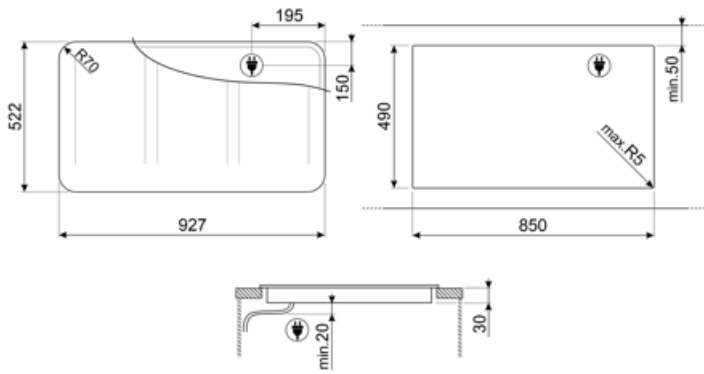

Compatibele Accessoires



GRILLPLATE

Universal griddle for induction, gas, ceramic and electric hobs. Non-stick surface ideal for cooking meat, cheese and vegetables. Dimensions: 410 x 240 mm.



TPKPLATE























Universal plate for induction, gas, ceramic and electric hobs. Non-stick surface ideal for cooking fish, eggs and vegetables. Dimensions: 410 X 240 mm.



SCRP

Inductie- en keramische kookplaten en teppanyaki-schraper

Symbols glossary

 <p>Permanent auto pot detection</p>	 <p>Connection between hob and hood</p>
 <p>Powerbooster: optie zorgt ervoor dat de zone op vol vermogen werkt wanneer zeer intensief koken nodig is.</p>	 <p>Kinderslot: sommige modellen zijn voorzien van een apparaat om het programma / de cyclus te vergrendelen zodat het niet kan per ongeluk veranderd</p>
 <p>Evolution Slider totally Back-lighted ghost effect</p>	 <p>The slider control panel allows you to adjust the power simply by passing your finger across the touch device.</p>
 <p>Darkness becomes light</p>	 <p>Grill function</p>
 <p>This function allows you to keep cooked food warm without burner it</p>	 <p>Overheat protection: The safety system that automatically turns off the hob in case of overheating of the control unit.</p>
 <p>Induction: The work of these hobs is based on the principle of electromagnetic induction. The heat is generated directly in the bottom of the pan during its contact with the hob.</p>	 <p>Multizone: allows several pans to be used at once, large or small, offering freedom of placement and greater flexibility</p>
 <p>Overfill protection: The special overfill protection shuts down the stove in the presence of overflow of liquids.</p>	 <p>Min diameter pot detection of 9 cm.</p>
 <p>All cooking zones can be reduced to the minimum power level, so the hob can be left unattended for a short period without food overcooking or burning. Then just press again this function, the previously set power levels can be reactivated.</p>	 <p>Possibility to set the maximum power absorption of the hob.</p>
 <p>Quick selection, with one touch cooking begins at the highest level, then automatically reduces after time. Ideal for dishes that require quick boiling and then continued cooking without constant control (eg beef broth).</p>	 <p>Quick Start function: the chosen temperature is reached faster. The heating element works at maximum power until the right temperature is reached.</p>
 <p>Indication of residual heat: After the glass ceramic hob is switched off the residual heat indicator shows which of the heating zones still remains hot. When the temperature drops below 60 ° C, the indicator goes out.</p>	 <p>Time elapsed: shows how long the cooking zone has been in use.</p>
 <p>Timer: All ceramic hobs have a timer which automatically ends cooking after a preset time.</p>	 <p>TWIN_ZONE_72dpi</p>