

SLB147X-2

EAN Code	8017709229672
Produktfamilie	Waschmaschine
Komm. Breite	60 cm
Komm. Tiefe	Standard
Installation	Standgerät
Beladungstyp	Frontlader



Programme

Bedienungsart	Elektronisch
Programmgrafik	Schriftzug (IT)
Anzahl der Waschprogramme	15
Programme	

 Weichspüler	 Hemden/Business	 Baumwolle
 Baumwolle ECO	 Pflegeleicht	 Jeans
 Wolle	 Handwäsche	 Mix
 Nacht	 Schnell	 Spülen/Schleudern
 Abpumpen/Schleudern	 Synthetik	 Sport

Variable Temperaturregelung

Kaltwäsche	30°C	40°C
60°C	75°C	90°C

Sonderprogramme

 Hemden/Business	 Jeans	 Nacht
 Kurz 15 min.	 Sport	

Displayanzeige

Restzeitanzeige

Zeitvorwahl

Füllmengenvorgabe

Programmstatus

Display



Sonderfunktionen



Zeitvorwahl



FlexiTime



Vorwäsche



Extraspülen



Schleuderausschluss



Bügelleicht



Intensiv



Kaltwäsche

Betriebsanzeige

Ja

Anzeige Programmstatus

Ja

Anzeige Programmende

Ja

Technische Eigenschaften



Motortyp	Standard	Türöffnungswinkel	180°
Elektronische Unwuchtkontrolle	Ja	Mengenautomatik	Ja
Programmwahl über Bedienknebel	Ja	Schaumerkennung	Ja
Variable Schleuderdrehzahl über Display/Led	Schleuderausschluss/ 600/ 800/ 1000/ 1200/ 1400	Unwuchtkontrolle	Ja
Temperaturregelung über Display	Ja	Flusensieb/Fremdkörperfalle herausnehmbar	Ja
Einspülkammer: Kunststoff (PP)	Ja	Tastensperre/Kindersicherung	Ja
Trommelmaterial	Edelstahl	Überlaufschutz	Ja
Trommelvolumen	54 l	Stop-Aqua	Total doppelt
Einsatz für Flüssigwaschmittel	Ja	Wasserschutzsystem	
Beladungsöffnung Ø	30 cm	Dualer Wasseranschluss (warm/kalt)	Ja

Technische Daten / Energielabel - Reg. 2019 - bindend ab 1.3.2021

Name oder Handelsmarke des Lieferanten

SMEG

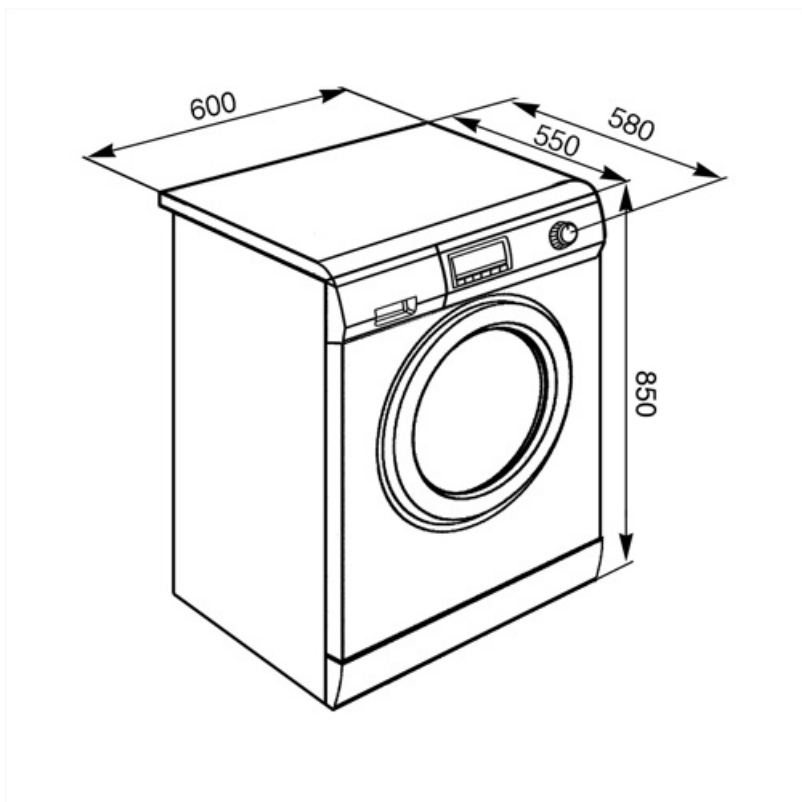



















Kompatibel Zubehör









KITPLV2



Kit 2 m Schlauchverlängerung für Wasserzu-/Ablauf in 3/4" inkl. Verbindungszubehör, geeignet für Geschirrspüler, Waschautomaten und Vollwaschtrockner

Symbols glossary

 <p>ACQUASTOP_DOUBLE_72dpi</p>	 <p>Easy Iron: this is an option which can be selected to ensure the finished laundry is left with less creases to make ironing easier.</p>
 <p>Variable load: In all models of washing machines is present the system of variable load, according to which the machine automatically diversifies the wash cycle and the time of operation depending on the quantity and type of laundry introduced, allowing a significant saving of water and energy power, up to 30% compared to the versions with fixed load.</p>	 <p>Automatic Load Balancing: provides an ideal distribution of laundry in the drum. In case if the imbalance is detected, the rotation speed starts being controlled in such way to evenly redistribute laundry in the drum, and thus reduce vibration.</p>
 <p>Kindersicherung: Eine Tastensperre, die einen ungewollten Zugriff auf die Funktionen verhindert.</p>	
 <p>Cold wash</p>	 <p>Delay timer: can be set to run the programme at a convenient time or to take advantage of off-peak energy periods.</p>
 <p>LED-Display: zur optischen Anzeige der gewählten Programme, Funktionen und Optionen sowie die Restlaufzeit bis Programmende.</p>	 <p>30 cm: Large loading hatch of 30-32-33 cm in diameter, makes laundry loading and unloading easier and faster with maximum ease of use.</p>
 <p>This option advises when the periodic cleaning of the filters is needed, in order to avoid forgetfulness and thus guarantee the perfect functioning of the dryer over time. The convenient position of the filters makes maintenance fast and extremely simple.</p>	 <p>Edelstahl mit Anti-Finger-Protektion: eine besondere Schutzschicht auf dem Edelstahl verhindert die Sichtbarkeit eines Fingerabdrucks und ist somit eine Pflegeerleichterung.</p>
 <p>FlexiTime: The FlexiTime option allows the user to reduce the time of the cycle selected, providing extra flexibility and control.</p>	 <p>Intensive: this option intensifies the selected program. Cycle duration and water consumption are reduced by taking into account the type of laundry, while still guaranteeing excellent washing results, even in the case of stains that are difficult to eliminate.</p>
 <p>No spin option: this option allows to exclude the last spin phase, draining the water from the tank</p>	 <p>Prewash: program designed for heavily soiled garments.</p>
 <p>Cotton: For soiled fabrics in cotton</p>	 <p>Use to wash your normally soiled, durable cotton and linen laundry. Although it washes longer than all other programmes, it provides high energy and water savings. Actual water temperature may be different from the stated wash temperature. When you load the machine with less laundry (e.g. ½ capacity or less), programme time may automatically get shorter. In this case, energy and water consumption will decrease more, providing a more economic wash. This programme is available in the models with the remaining time indicator.</p>

 <p>Delicate: Clothing such as underwear, hosiery and luxury fabrics should be dried on the delicate cycle to help extend the life of the clothing.</p>	 <p>To drain the water in the machine.</p>
 <p>Verlängerte Nachspülung</p>	 <p>Hand wash: this specific programme for delicate fabrics uses slower rotations of the drum to ensure the utmost care for clothing.</p>
 <p>Jeans: a washing cycle which is kind to the colour and fabric of denim whilst minimising wrinkles.</p>	 <p>Mixed fabrics: this cycle is designed for lightly soiled laundry in a mix of cottons and synthetics, or can be used just to refresh stored items.</p>
 <p>PRG NACHT</p>	 <p>Super fast 15 min: a programme designed to wash small amounts of laundry fast, ideal for washing lightly soiled garments.</p>
 <p>Super fast: a programme designed to wash small amounts of laundry fast, ideal for washing lightly soiled garments.</p>	 <p>To drain the water into the basket + centrifuge action</p>
 <p>Shirts: a cycle to wash shirts in a short time with the utmost care, using a delicate spin for easy ironing.</p>	 <p>Softener</p>
 <p>Gym: Gym, a cycle designed for washing lightly soiled garments, ie sports wear, this is a fast wash which is also kind to fabrics.</p>	 <p>Synthetics: to wash your synthetic clothes (shirts, blouses, synthetic/cotton blends, etc.). It washes with a gentle action and has a shorter washing cycle compared to the Cottons programme. For curtains and tulle, use the Synthetic 40°C programme with prewash and anti-creasing functions selected. As their meshed texture causes excessive foaming, wash the veils/tulle by putting little amount of detergent into the main wash compartment. Do not put detergent in the prewash compartment.</p>
 <p>Wool: this programme for wool or delicate fabrics uses slower rotations of the drum to ensure the utmost care for clothing.</p>	 <p>Drum has maximum capacity of 7kg of dry laundry.</p>