

# SO4101M0B3

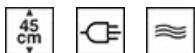

<b>Categorie</b>	45 cm
<b>Product familie</b>	Oven
<b>Stroomvoorziening</b>	Elektrisch
<b>Warmtebron</b>	Elektriciteit
<b>Bereidingswijze</b>	Microgolf met grill
<b>Galileo technologie</b>	Micro + grill
<b>EAN-code</b>	8017709341633



## Design

<b>Design</b>	Linea	<b>Deur</b>	Geheel glas
<b>Kleur</b>	Zwart	<b>Handvat</b>	Linea minimal
<b>Design</b>	Plat	<b>Kleur handvat</b>	Zwart
<b>Materiaal</b>	Glas	<b>Logo</b>	Geëst
<b>Type glas</b>	Clear1	<b>Bedieningsknoppen</b>	Linea
<b>Kleur serigrafie</b>	Grijs	<b>Kleur bedieningsknoppen</b>	Zwart
<b>Type zeefdruk</b>	Symbolen		

## Bediening



<b>Display</b>	CompactScreen	<b>Bediening</b>	Bedieningsknoppen
<b>Display</b>	LCD	<b>Aantal bedieningsknoppen</b>	2

## Programma's / Functies

<b>Aantal kookfuncties</b>	4
<b>Individualiseerbare recepten</b>	No
<b>Traditionele bereidingsfuncties</b>	



Grote grill

## Bereidingsfuncties met microgolven



Microgolfoven



Microgolf + grill



Crisp

## Overige functies



Ontdooien op tijd

## Opties



Tijdsinstelling	Automatische in- en uitschakeling	Kinderbeveiliging	Ja
Timer	Ja	Andere opties	
Timer	1	Showroom demo optie	Ja

## Technische specificaties



Inhoud (l)	40 l	Opening deur	Standaard opening
Cavity	QS-Galileo	Deur	Temperatuur gecontroleerde deur
Minimum temperatuur	30 °C	Totaal aantal ruiten	3
Maximum temperatuur	280 °C	Automatische uitschakeling microgolf bij openen deur	Ja
Aantal kookniveaus	2	Chimney	Fixed
Aantal lampen	1	Koelsysteem	Mantelkoeling
Type lamp	Halogeen	Koelleiding	Enkel
Vermogen lamp	40 W	Afmetingen bruikbare interne ovenruimte (hxbxd)	240x462x401 mm
Verlichting bij opening deur	Ja	Temperatuurcontrole	Elektronisch
Grill - vermogen	1500 W	Materiaal ovenruimte	Ever Clean emaille
Warmte onderbroken bij openen deur	Ja	Veiligheidsscherm microgolfdeur	Ja

## Prestaties / energielabel



Netto volume	40 l	Effectief vermogen microgolf	800 W
Aantal ovens	1		

## Meegeleverde accessoires

Ovenrooster met stop	1
----------------------	---

## Elektrische aansluiting

Spanning	220-240 V	Nominale aansluitwaarde	3000 W
Stekker	Nee	Frequentie	50 Hz
Stroom	13 A	Lengte voedingskabel	150 cm

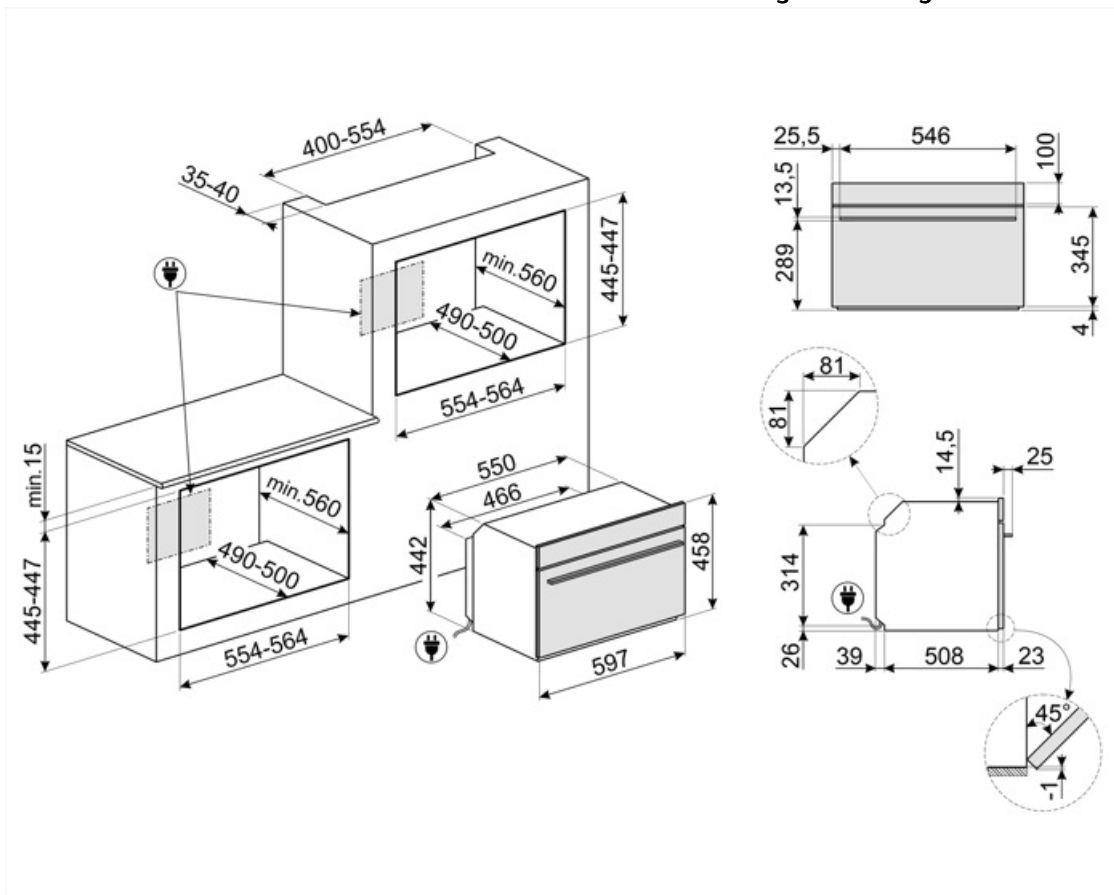

---

## Compatible Accessories

---

### BBQ

Dubbelzijdig



### ET20

Geëmailleerde ovenschaal voor 45cm en 60cm ovens. Diepte 20 mm.



### ET50

Geëmailleerde ovenschaal voor 45cm en 60cm ovens. Diepte 50 mm.





















### STONE2

Rectangular pizza stone without handles, suitable for 45cm and 60cm wide ovens. Dimensions W42 x H1.8 x D37.5cm. Ideal for cooking pizzas with the same results as a typical wood-fired oven. Can also be used for baking bread, focaccias and other recipes such as pies, flans or biscuits



## Symbols glossary

 <p>Sommige modellen zijn voorzien van een functie om het programma/de cyclus te blokkeren zodat het niet per ongeluk kan aangepast worden.</p>	 <p>Microwave energy shortens cooking times dramatically and produces energy savings.</p>
 <p>Air cooling system: to ensure a safe surface temperatures.</p>	 <p>Defrost by time: Manual defrost function. At the end of the set duration, the function stops.</p>
 <p>Triple glazed doors: Number of glazed doors.</p>	 <p>Elektrische aansluiting</p>
 <p>Ever Clean Enamel: Ever Clean enamel is applied electrostatically, corner to corner and edge to edge to prevent cracking or cracks over time. It is a particular pyrolytic enamel, resistant to acids which, in addition to being pleasantly bright, promotes greater cleaning of the oven walls, thanks to its lower porosity. It is baked at over 850 °C and slowly polymerized at a scientifically determined rate to ensure uniform depth and strength. Ever Clean enamel creates an impeccable finish both on the inside of the oven and on the trays, making the surfaces of the oven incredibly easy to maintain over time as it reduces the adhesion of fat during cooking.</p>	 <p>Crisper: The simultaneous operation of the microwave, grill and crisper plate (once pre-heated) allows the food to go crispy and golden, ideal for cooking Pizza etc.</p>
 <p>Grill: Very intense heat coming only from above from a double heating element. The fan is not active. Provides excellent grilling and gratinating results. Used at the end of cooking, it gives a uniform browning to dishes.</p>	 <p>Microwave: Penetrating straight into the food, microwaves cook very quickly and with considerable energy savings. Suitable for cooking without fat, they are also able to thaw and heat food without altering its original appearance and aroma. The microwave function can also be combined with conventional functions with all the resulting advantages. Ideal for all types of food.</p>
 <p>Microwave + grill element: The use of the grill results in a perfect browning of the surface of the food. The action of microwaves allows instead of cooking in a short time the internal part of the food.</p>	 <p>Compacte toestellen met een hoogte van 45 cm - perfecte oplossing om te voldoen aan de functionele eisen van keukensets met een kleine hoogte. Verkrijgbaar in verschillende soorten en in verschillende stijlen.</p>
 <p>Side lights: Two opposing side lights increase visibility inside the oven.</p>	 <p>The oven cavity has 2 different cooking levels.</p>
 <p>Electronic control: Allows you to maintain temperature inside the oven with the precision 2-3 ° C. This enables to cook meals that are very sensitive to temperature changes, such as cakes, souffles, puddings.</p>	 <p>Tilting grill: the tilting grill can be easily unhooked to move the heating element and clean the roof of the appliance in one simple step.</p>
 <p>The capacity indicates the amount of usable space in the oven cavity in litres.</p>	 <p>The capacity indicates the amount of usable space in the oven cavity in litres.</p>
 <p>COMPACTscreen display + bedieningsknoppen</p>	