

SO4101M0B3K

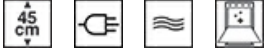

Category	45 cm
Product Family	Oven
Power supply	Electric
Heat source	ELECTRICITY
Cooking method	Microwave with grill
Galileo platform	Micro + grill
Cleaning system	Ever Clean enamel
EAN code	8017709329495



Aesthetics

Aesthetic	Linea	Serigraphy type	Symbols
Colour	Black	Door	Full glass
Finishing	Glossy	Handle	Linea minimal
Design	Flat	Handle Colour	Black
Material	Glass	Logo	Silk screen
Glass Type	Clear	Control knobs	Linea
Serigraphy colour	Grey	Controls colour	Matt black

Controls



Display name	CompactScreen	Control setting	Knobs
Display technology	LCD	No. of controls	2

Programme / Functions

No. of cooking functions 4
Traditional cooking functions



Microwave functions

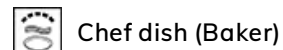

Other functions

 Defrost by time

Options



Time-setting options	Delay start and automatic end cooking	Controls Lock / Child Safety	Yes
Minute minder	Yes	Showroom demo option	Yes
Timer	1		

Technical Features



Minimum Temperature	30 °C	Door	Temperate door
Maximum temperature	280 °C	Total no. of door glasses	3
No. of shelves	2	Microwave stops when door is opened	Yes
No. of lights	1	Chimney	Fixed
Light type	Halogen	Cooling system	Tangential
Light Power	40 W	Cooling duct	Single
Light when door is opened	Yes	Usable cavity space dimensions (HxWxD)	240x462x401 mm
Grill element - power	1500 W	Temperature control	Electronic
Heating suspended when door is opened	Yes	Cavity material	Ever clean Enamel
Door opening type	Standard opening	Microwave screen protection	Yes

Performance / Energy Label



Net volume of the cavity	40 l	Microwave effective power	800 W
Number of cavities	1		

Accessories Included

Rack with back stop (concave) 1

Electrical Connection







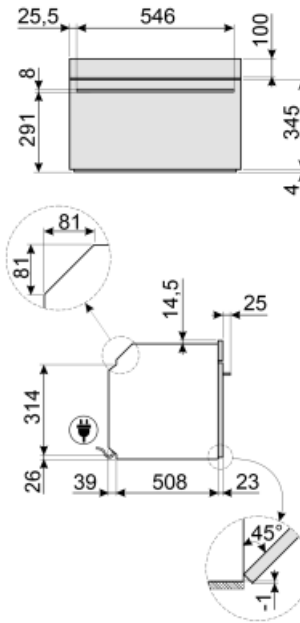
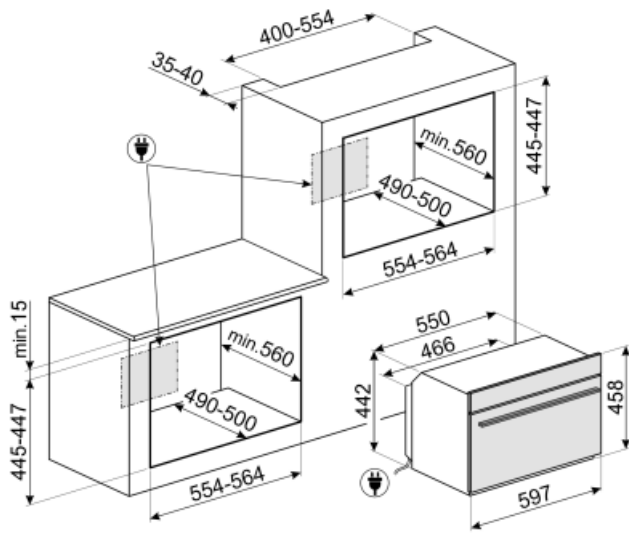











Plug	Not present	Nominal power	3000 W
Voltage	220-240 V	Frequency (Hz)	60 Hz
Current	13 A		

Power supply cable
length

150 cm



Symbols glossary (TT)

 <p>Child lock: some models are fitted with a device to lock the programme/cycle so it cannot be accidentally changed.</p>	 <p>Microwave energy shortens cooking times dramatically and produces energy savings.</p>
 <p>Air cooling system: to ensure a safe surface temperatures.</p>	 <p>Defrost by time: Manual defrost function. At the end of the set duration, the function stops.</p>
 <p>Triple glazed doors: Number of glazed doors.</p>	 <p>Electric</p>
 <p>Ever Clean Enamel: Ever Clean enamel is applied electrostatically, corner to corner and edge to edge to prevent cracking or cracks over time. It is a particular pyrolytic enamel, resistant to acids which, in addition to being pleasantly bright, promotes greater cleaning of the oven walls, thanks to its lower porosity. It is baked at over 850 ° C and slowly polymerized at a scientifically determined rate to ensure uniform depth and strength Ever Clean enamel creates an impeccable finish both on the inside of the oven and on the trays, making the surfaces of the oven incredibly easy to maintain over time as it reduces the adhesion of fat during cooking</p>	 <p>Crisper: The simultaneous operation of the microwave, grill and crisper plate (once pre-heated) allows the food to go crispy and golden, ideal for cooking Pizza etc</p>
 <p>Grill: Very intense heat coming only from above from a double heating element. The fan is not active. Provides excellent grilling and gratinating results. Used at the end of cooking, it gives a uniform browning to dishes.</p>	 <p>Microwave: Penetrating straight into the food, microwaves cook very quickly and with considerable energy savings. Suitable for cooking without fat, they are also able to thaw and heat food without altering its original appearance and aroma. The microwave function can also be combined with conventional functions with all the resulting advantages. Ideal for all types of food.</p>
 <p>Microwave + grill element: The use of the grill results in a perfect browning of the surface of the food. The action of microwaves allows instead of cooking in a short time the internal part of the food.</p>	 <p>Compact appliances with a height of 45 cm - perfect solution to meet the functional requirements of kitchen sets of small height. Available in several types and in different styles.</p>
 <p>Side lights: Two opposing side lights increase visibility inside the oven.</p>	 <p>The oven cavity has 2 different cooking levels.</p>
 <p>Electronic control: Allows you to maintain temperature inside the oven with the precision 2-3 ° C. This enables to cook meals that are very sensitive to temperature changes, such as cakes, souffles, puddings.</p>	 <p>Tilting grill: the tilting grill can be easily unhooked to move the heating element and clean the roof of the appliance in one simple step.</p>
 <p>The capacity indicates the amount of usable space in the oven cavity in litres.</p>	 <p>With a simple and intuitive interface, the COMPACTscreen provides a pleasant user experience, thanks to the interaction with the knobs.</p>