

# SO4104APG



Category	45cm compact
Product Family	Oven
Vitality system	Yes
Power supply	Electric
Heat source	Electric
Cooking method	Multitech
Galileo cavity	Omnichef
Cleaning system	Vapor Clean
EAN code	8017709326784



## Aesthetics

Aesthetics	Linea	Glass Type	Clear1
Colour	Neptune Grey	Serigraphy colour	Black
Finishing	Matte	Door	Full glass
Design	Flat	Handle	Linea minimal
Component finish	Silver	Handle Colour	Satin metal and black
Material	Glass	Logo	Applied

## Controls



Display name	VivoScreen	No. of display languages	20
Display technology	TFT	Display languages	Italiano, English (UK), Français (FR), Français (CA), Nederlands, Español (ES), Español (MX), Português (PT), Svenska, Русский, Deutsch (DE), Dansk, Norsk, Polski, English (AU), Suomi, Ukrainian, Kazakh, Afrikaans (ZA), Zulu (ZA)
Control setting	Advanced full touch		

## Programs / Functions

No. of cooking functions	26
Automatic programmes	150
Steam assisted levels	3 + manual

**Customisable recipes**

10

**Traditional cooking functions**



Static



Fan assisted



Circulaire



Turbo (circulaire + bottom + upper + fan)



ECO



Large grill



Fan grill (large)



Base



Circulaire + bottom



Pizza

**Cooking functions with pulsed steam**



Fan assisted



Circulaire



Circulaire + Bottom + Fan



Turbo (circulaire + bottom + upper + fan)



Fan Grill

**Cooking functions with steam**



Manual steam



Steam + bottom + upper + fan



Steam + circulaire + fan

Circulaire + Bottom + Fan



Sous Vide

**Other Steam functions**



Tank cleaning



Water outlet



Water input



Descaling

**Microwave functions**



Microwave



Microwave + bottom + top + fan



Microwave + circulaire + fan



Microwave + grill

Microwave + Circulaire + bottom

**Microwave functions**

Multitech

Twintech

### Other functions

Defrost by time	Defrost by weight	Proving
Stone cooking	BBQ	Air-Fry
Melt	Soft	Pop-corn
Keep warm	Plate rack/warmer	Sabbath

### Cleaning functions

Vapor Clean
-------------

## Options



<b>Time-setting options</b>	Delay start and automatic end cooking	<b>SameTime</b>	Yes
<b>Minute minder</b>	Yes	<b>DeltaT cooking</b>	Yes
<b>Timer</b>	3	<b>Showroom demo option</b>	Yes
<b>Controls Lock / Child Safety</b>	Yes	<b>Demo-tutorial mode</b>	Yes
<b>Other options</b>	Keep warm, Eco light, Language setting, Digital clock display, Brightness, Tones, Tones volume	<b>Touch guide</b>	Yes
<b>Cooking with probe thermometer</b>	Yes	<b>History</b>	Yes, the last 10 functions utilised
<b>Multi-step cooking</b>	Yes, up to 2 steps	<b>Rapid pre-heating</b>	Yes
<b>Smart cooking</b>	Yes	<b>Instant GO</b>	Yes

## Technical Features



<b>Minimum Temperature</b>	30 °C	<b>Total no. of door glasses</b>	4
<b>Maximum temperature</b>	250 °C	<b>Soft Close hinges</b>	Yes
<b>Shelf positions</b>	2	<b>Soft Open</b>	Yes
<b>No. of lights</b>	1	<b>Inverter</b>	Yes
<b>Light type</b>	LED	<b>Stirrer</b>	Yes
<b>Light power</b>	3 W	<b>Chimney</b>	Double
<b>Light when door is opened</b>	Yes	<b>Cooling system</b>	Centrifugal
<b>Lower heating element power</b>	1200 W	<b>Cooling duct</b>	Double
<b>Upper heating element - Power</b>	1000 W	<b>Speed Reduction Cooling System</b>	Yes
<b>Grill element - power</b>	1700 W	<b>Door Lock During Pyrolysis</b>	Yes
<b>Large grill - Power</b>	2700 W	<b>Steam range</b>	20 - 100%

<b>Circular heating element - Power</b>	1400 W	<b>Usable cavity space dimensions (HxWxD)</b>	214x462x397 mm
<b>Heating suspended when door is opened</b>	Yes	<b>Temperature control</b>	Electronic
<b>Door opening type</b>	Standard opening	<b>Cavity material</b>	Easy clean enamel
<b>Door</b>	Cool	<b>Water loading</b>	Fill&Hide 2 , automatic
<b>Full glass inner door</b>	Yes	<b>Tank capacity</b>	2 l

## Performance / Energy Label



<b>Net volume of the cavity</b>	40 litres	<b>Microwave effective power</b>	900 W
<b>Number of cavities</b>	1		

## Accessories Included



<b>Chrome shelf</b>	1	<b>St/steel perforated deep tray (40mm)</b>	1
<b>Enamelled deep tray (50mm)</b>	1	<b>Glass tray</b>	1
<b>Grill mesh</b>	1	<b>Telescopic Guide rails, total Extraction</b>	1
<b>St/steel tray (20mm)</b>	1	<b>Temperature probe</b>	Yes, multipoint

## Electrical Connection

<b>Voltage</b>	220-240 V	<b>Frequency (Hz)</b>	50/60 Hz
<b>Current</b>	13 A	<b>Power supply cable length</b>	150 cm
<b>Nominal power (W)</b>	3000 W		

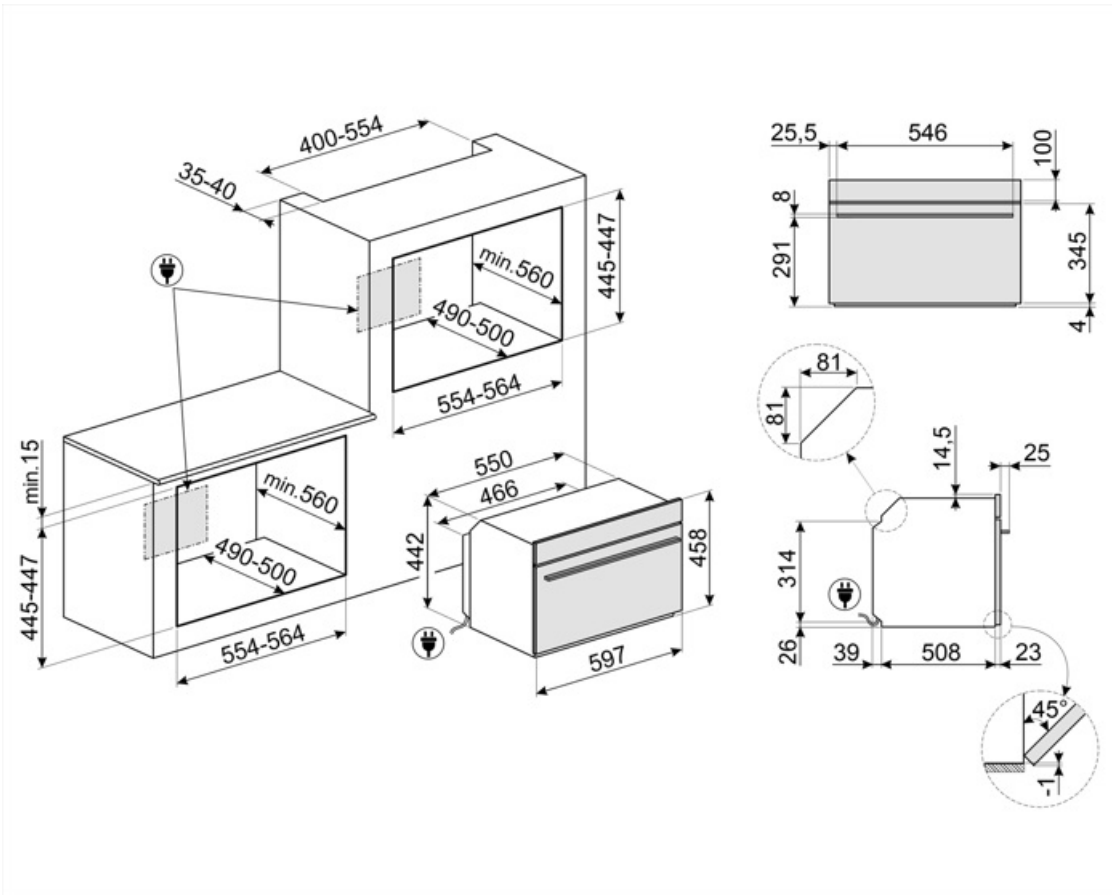

## Not included accessories

### AIRFRY

Air fryer rack AIRFRY . Ideal for recreating traditional frying in the oven, but with fewer calories and less fat. It allows you to cook quickly and simply dishes such as French fries, fried vegetables and fish, ensuring perfect browning and crispiness.



### BN620-1

Enamelled tray, 20mm deep



### BX640PL

Stainless steel perforated tray. To cook many types of vegetables, fish, white meats, ravioli or other varieties of stuffed pasta, preserving all the vitamins and mineral salts for a richer, fuller and natural flavour



### ET50

Enamelled tray, 50mm deep



### GTTV2

Totally extractable telescopic guides (1 level), suitable for steam ovens. Made in stainless steel, they guarantee stability and facilitate the smooth extraction of the trays.



### PR3845N

Black spacer cover for furniture when more ovens are installed in column. Suitable for 45cm Dolce Stil Novo compact ovens.



### BBQ

Double sided plate BBQ. Suitable for recreating succulent and crispy dishes in the oven with the typical taste of grilled cooking. The ribbed side is particularly suitable for meats and cheeses. The smooth side for fish, seafood and vegetables.



### BN640

Enamelled tray, 40mm deep

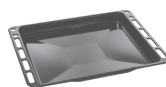

### ET20

Enamelled tray, 20mm deep



### GTP2

Partially extractable telescopic guides (1 level), suitable for traditional ovens. Made in stainless steel, they guarantee stability and facilitate the smooth extraction of the trays.



### PALPZ

Pizza shovel with fold away handle width: 315mm length : 325mm



















### PR3845X

Antifingerprint stainless steel. Cover for furniture in column installation of more ovens





## Symbols glossary

 <p>Child lock: some models are fitted with a device to lock the programme/cycle so it cannot be accidentally changed.</p>	 <p>Defrost by time: with this function the time of thawing of foods are determined automatically.</p>
 <p>Defrost by weight: With this function the defrosting time is determined</p>	 <p>Descaling function: Is essential to remove excess deposits of limestone in the tank and allow the proper operation of the product. The need to perform this operation is signaled by the product itself.</p>
 <p>Quadruple glazed: Number of glazed doors.</p>	 <p>Automatic lighting switches off: for greater energy savings, the lighting switches off automatically after one minute from the start of cooking.</p>
 <p>Electric</p>	 <p>Enamel interior: The enamel interior of all Smeg ovens have a special antacid lining which helps keep the interior clean by reducing the amount of cooking grease adhering to it.</p>
 <p>Fresh Touch: Most of Smeg ovens have a "cool door." Thanks to the combination of tangential cooling and internal heat-reflecting glasses, the temperature on the outer surface of the door is maintained below 50° C. In addition to providing safety, this system protects the sides of the furniture from overheating by the oven.</p>	 <p>Fan with upper and lower elements: The elements combined with the fan aim to provide more uniform heat, a similar method to conventional cooking, so pre-heat is required. Most suitable for items requiring slow cooking methods.</p>
 <p>Upper and lower element only: a traditional cooking method best suited for single items located in the centre of the oven. the top pf the oven will always be hottest. Ideal for roast, fruit cakes, bread etc.</p>	 <p>Lower heating element only: This function is ideal for foods that require extra base temperature without browning, e.g. pastry dishes, pizza. Also suitable for slow cooking of stews and casseroles.</p>
 <p>Circulaire with lower element: The addition of the lower element adds extra heat at the base for food which requires extra cooking.</p>	 <p>Circulaire: The combination of the fan and circular element around it gives a hot air cooking method. This provides many benefits including no preheat if cook time is more than 20 minutes, no flavour transfer when cooking different foods at the same time, less energy, and shorter cook times. Good for all types of food.</p>
 <p>ECO: The combination of the grill, fan and lower element is particularly suitable for cooking small quantities of food.</p>	 <p>Grill element: Using of grill gives excellent results when cooking meat of medium and small portions, especially when combined with a rotisserie (where possible). Also ideal for cooking sausages and bacon.</p>

- 

Fan with grill element: The fan reduces the fierce heat from the grill, providing an excellent method of grilling various foods, chops, steaks, sausages etc. giving even browning and heat distribution, without drying out the food. The top two levels recommended for use, and the lower part of the oven can be used to keep items warm at the same time, an excellent facility when cooking a grilled breakfast. Half grill (centre portion only) is ideal for small quantities of food.



Microwave: Penetrating straight into the food, microwaves cook very quickly and with considerable energy savings. Suitable for cooking without fat, they are also able to thaw and heat food without altering its original appearance and aroma. The microwave function can also be combined with conventional functions with all the resulting advantages. Ideal for all types of food.
- 

Cooking with the simultaneous use of the heating element in combination with fan and microwave supply.



Microwave + grill element: The use of the grill results in a perfect browning of the surface of the food. The action of microwaves allows instead of cooking in a short time the internal part of the food.
- 

Fan combined with traditional cooking, where heat is generated from above and below, provides uniform heat. Adding the microwave function allows the same cooking results in less time.



Pizza function: The simultaneous operation of three elements ensures an optimum cooking facility when used with the Smeg pizza stone.
- 

Sous Vide Cooking: Steam function for perfect cooking of sous vide dishes. Enhances the taste of dishes and keeps their appearance and nutrients unaltered. Vacuum cooking (Sous Vide) made with the help of a steam oven is also an incredibly healthy and genuine type of cooking. The Sous Vide cooking technique allows heat to be efficiently transferred from the steam to the food, avoiding the loss of flavour due to oxidation and the evaporation of nutrients and moisture during cooking. Sous Vide cooking also allows better control over the cooking of food compared to traditional methods, ensuring uniform cooking results. It also allows cooking at a lower temperature than traditional cooking.



Steam cooking: it's a natural way of cooking for any kind of products, from vegetables to desserts, to preserve the nutritional and organoleptic properties of ingredients. Ideal for cooking without fat, to heat up food without drying. Steam is ideal for simultaneous cooking of meals that require different cooking times.
- 

Fan combined with traditional cooking, where heat is generated from above and below, provides uniform heat. Adding the steam function allows the same cooking results in less time.



Circulaire element with steam: Cooking with the simultaneous use of the circular heating element in combination with fan and steam supply.
- 

FUN\_STEAM\_OTHER\_WATER\_IN\_OUT\_72dpi















Circulaire with upper and lower elements: The use of the fan with both elements allows food to be cooked quickly and effectively, ideal for large joints that require thorough cooking. It offers a similar result to rotisserie cooking. It offers a similar result to rotisserie, moving the heat around the food, instead of moving the food itself, enabling any size or shape to be cooked.
- 

Fan with grill with steam assist: For creating a perfectly roasted meat joint. The extra moisture keeps the meat juicy and tender, whilst the heat from the turbo function creates the caramelised flavours we know and love.



Circulaire with steam assist: Provides extra moisture to food during cooking. Excellent for bread baking. The moisture allows the bread dough to stretch further at the beginning of cooking, creating an aerated and light textured dough. The remaining part of the cooking process allows for the signature crust to form.



-  **Circulaire + lower element with steam assist:** Ideal for reheating flans and quiches. This function will re-crisp the base, whilst filling will not dry out due to the additional moisture in the cooking cavity.
-  **Turbo with steam assist:** For creating a perfectly roasted meat joint. The extra moisture keeps the meat juicy and tender, whilst the heat from the turbo function creates the caramelised flavours we know and love.
-  **All glass inner door:** All glass inner door, a single flat surface which is simple to keep clean.
-  **Warming up:** An option for dish warming and keeping the prepared meals hot.
-  **Air at 40°C** provides the perfect environment for proving yeast type dough mixes. Simply select the function and place dough in the cavity for allotted
-  **Sabbath:** This function allows you to cook food whilst respecting the provisions of the Jewish day of rest.
-  **The oven cavity has 2 different cooking levels.**
-  **Soft close:** all models are equipped with advanced function of smooth closing of the door, which allows the device to close smoothly and quietly.
-  **Telescopic rails:** allow you to pull out the dish and check it without having to remove it from the oven entirely.
-  **Vapor Clean:** a simple cleaning function using steam to loosen deposits in the oven cavity.
-  **Circulaire with steam assist:** Provides extra moisture to food during cooking. Excellent for bread baking. The moisture allows the bread dough to stretch further at the beginning of cooking, creating an aerated and light textured dough. The remaining part of the cooking process allows for the signature crust to form.
-  **Compact appliances with a height of 45 cm -** perfect solution to meet the functional requirements of kitchen sets of small height. Available in several types and in different styles.
-  **Keep warm:** This function allows you to keep precooked foods warm.
-  **Cooking with temperature probe:** It is possible to display the temperature detected by the probe and set a target temperature that the dish must reach. When the core of the dish reaches the desired temperature, cooking stops
-  **Rapid preheat:** The rapid preheat function can be used to reach the selected temperature in just a few minutes.
-  **Touch guide:** By holding down any symbol for 3 seconds you can get information on its function
-  **Smart Cooking System:** for the perfect cooking it is simply necessary choosing the kind and the weight of food and the cooking temperature: any other setting will be established automatically.
-  **To guarantee the optimal functioning of the appliance,** it is suggested to carry out the tank cleaning roughly once every 2-3 months.
-  **Electronic control:** Allows you to maintain temperature inside the oven with the precision 2-3 ° C. This enables to cook meals that are very sensitive to temperature changes, such as cakes, souffles, puddings.
-  **The capacity indicates the amount of usable space in the oven cavity in litres.**

- 

The capacity indicates the amount of usable space in the oven cavity in litres.



The 4.3" VIVOscreen display offers an advanced colour touch interface, for automatic management of firing programmes such as Delta T, Multi-step and SameTime firing.
- 

...



Instant go: activating this option allows cooking to start immediately. Preheating is included in the cooking time and the oven will gradually reach the desired temperature. Particularly suitable for frozen foods.
- 

Stirrer Active and controlled microwave distribution. The Microwave Stirrer fan distributes the waves evenly within the oven, reducing the need for a turntable.



...
- 

Multicooking Technology: combine up to three different technologies and take the best out of them: steam, microwave, and convection cooking.



Fill & Hide: The water load system is designed to enhance the aesthetics of the oven. The loading and unloading tube can be easily removed from the oven and the water refilled at any time during the cooking cycle, without opening the door, guaranteeing an infinite duration of steam.
- 

Sametime: The perfect way to have a complete menu in a few simple steps. The SameTime algorithm calculates the times, the cooking functions and all the parameters so that 3 foods can be ready at the same time.



The inverter technology allows to generate microwaves continuously and at the desired power. The constant flow, without on and off cycles, allows you to precisely control the temperature, reduce times, avoids wasting energy and allows you to obtain excellent cooking, defrosting and re-heating results, thanks to the smaller difference between core and surface temperature in food.
- 

Dedicated cooking function for the double sided plate BBQ. Suitable for recreating succulent and crispy dishes in the oven with the typical taste of wood-fire.



Dedicated cooking function for the Air fryer rack AIRFRY. Ideal for recreating traditional frying in the oven, but with fewer calories and less fat.
- 

Dedicated cooking function for the rectangular refractory stone PPR2. Dimensions ideal for cooking pizzas with the same results as a typical wood-fire.



Chimney: The double chimney technology creates a special airflow inside the cavity that reduces the condensation inside the cavity during microwave cooking.
- 

DeltaT cooking: The oven automatically sets the cavity temperature to a predefined temperature (named deltaT) higher than the core temperature detected by the probe. When the probe detects an extra degree at the core, the oven automatically increases also its internal temperature by one degree.



Function to melt butter and chocolate without using the bain-marie.
- 

Function to soften butter and cheese. It is useful for quickly bringing frozen desserts to serving temperature. The function can also be used to soften ice cream.



Function for the preparation of popcorn packaged in bags.