

SO4204M2PBI



Categorie	45 cm
Product familie	Oven
Stroomvoorziening	Elektrisch
Warmtebron	Elektriciteit
Bereidingswijze	Combi-microgolf
Galileo technologie	Speedwave
Reinigingssysteem	Vapor Clean reiniging
EAN-code	8017709365530



Design

Design	Musa	Type zeefdruk	Symbolen
Kleur	Zwart	Deur	Geheel glas
Design	Plat	Handvat	Musa
Materiaal	Glas	Kleur handvat	Zwart
Type glas	Eclipse zwart glas	Logo	Geëtst
Kleur serigrafie	Grijs		

Bediening



Display	VivoScreen	Aantal talen display	20
Display	Touch display	Display talen	Italiano, English (UK), Français (FR), Français (CA), Nederlands, Español (ES), Español (MX), Português (PT), Svenska, Русский, Deutsch (DE), Dansk, Norsk, Polski, English (AU), Suomi, Ukrainian, Kazakh, Afrikaans (ZA), Zulu (ZA)
Bediening	Full touch bediening		







Programma's / Functies

Aantal kookfuncties	15
Automatische programma's	150
Individualiseerbare recepten	10

Traditionele bereidingsfuncties

-  Statisch
-  Statisch + ventilator
-  Circulatie (ventilator + circulaire)
-  Turbo: ventilator + circulaire +
statisch
-  ECO
-  Grote grill
-  Ventilator + grote grill
-  Onderwarmte
-  Circulaire + onderwarmte
-  Pizza

Bereidingsfuncties met microgolven

-  Microgolfoven
-  Microgolf + boven- en onderwarmte
+ ventilator
-  Microgolf + circulaire + ventilator
-  Microgolf + grill
-  Microgolf + Circulaire +
Onderwarmte
-  Verwarmen en regenereren

Overige functies

-  Ontdooien op tijd
-  Ontdooien op gewicht
-  Rijzen
-  Stone cooking
-  BBQ
-  Air-Fry
-  Melt
-  Soft
-  Pop-corn
-  Warmhouden
-  Bordenwarmfunctie
-  Sabbath











Reinigingsfuncties

-  Vapor Clean reiniging

Sabbath Mode

Yes

Opties

- | | | | | | | | | | | | |
|--|---|---|---|---|---|---|---|---|---|---|--|
|  |  |  |  |  |  |  |  |  |  |  | |
| Tijdsinstelling | | | | Automatische in- en uitschakeling | | | | Same Time cooking | | Ja | |
| Timer | | | | Ja | | | | DeltaT cooking | | Ja | |

Timer	3	Showroom demo optie	Ja
Kinderbeveiliging	Ja	Begeleide demo functie	Ja
Andere opties	Warmhoudfunctie, Eco light, Taalinstelling, Weergave digitale klok, ECO-Logic, Geluiden, Helderheid, Volume geluiden	Snelgids	Ja
Koken met temperatuursonde	Ja	Chronologie	Ja, de 10 laatst gebruikte functies
Multi-step cooking	Tot 2 stappen instelbaar	Snel voorverwarmen	Ja
Smart cooking	Ja	Instant GO	Ja

Technische specificaties



Inhoud (l)	40 l	Opening deur	Standaard opening
Cavity	QS-Galileo	Deur	Temperatuur gecontroleerde deur
Minimum temperatuur	25 °C	Totaal aantal ruiten	3
Maximum temperatuur	250 °C	Automatische uitschakeling microgolf bij openen deur	Ja
Aantal kookniveaus	2	Soft Close scharnieren	Ja
Aantal lampen	1	Soft open & close scharnieren	Ja
Type lamp	LED	Inverter technologie	Ja
Vermogen lamp	3 W	Stirrer	Ja
Verlichting bij opening deur	Ja	Chimney	Double
Onderwarmte - vermogen	1200 W	Koelsysteem	Mantelkoeling
Bovenwarmte - vermogen	1000 W	Koelleiding	Enkel
Grill - vermogen	1700 W	Afmetingen bruikbare interne ovenruimte (hxbxd)	214x462x397 mm
Grote vlakgrill - vermogen	2700 W	Temperatuurcontrole	Elektronisch
Circulatie - vermogen	1400 W	Materiaal ovenruimte	Ever Clean emaille
Warmte onderbroken bij openen deur	Ja	Veiligheidsscherm microgolfdeur	Ja

Prestaties / energielabel



Netto volume	40 l	Effectief vermogen microgolf	900 W
Aantal ovens	1	Microwave - Output power	900 W

Meegeleverde accessoires



Ovenrooster met stop	1	Telescopische geleiders, 1 volledig uitschuifbaar	
Inzetrooster	1		
Glazen ovenplaat	1	Temperatuur sonde	Ja, driepunt temperatuursonde

Elektrische aansluiting

Spanning	220-240 V	Nominale aansluitwaarde	3000 W
Stekker	Cable with free ends	Frequentie	50/60 Hz
Stroom	13 A	Lengte voedingskabel	150 cm

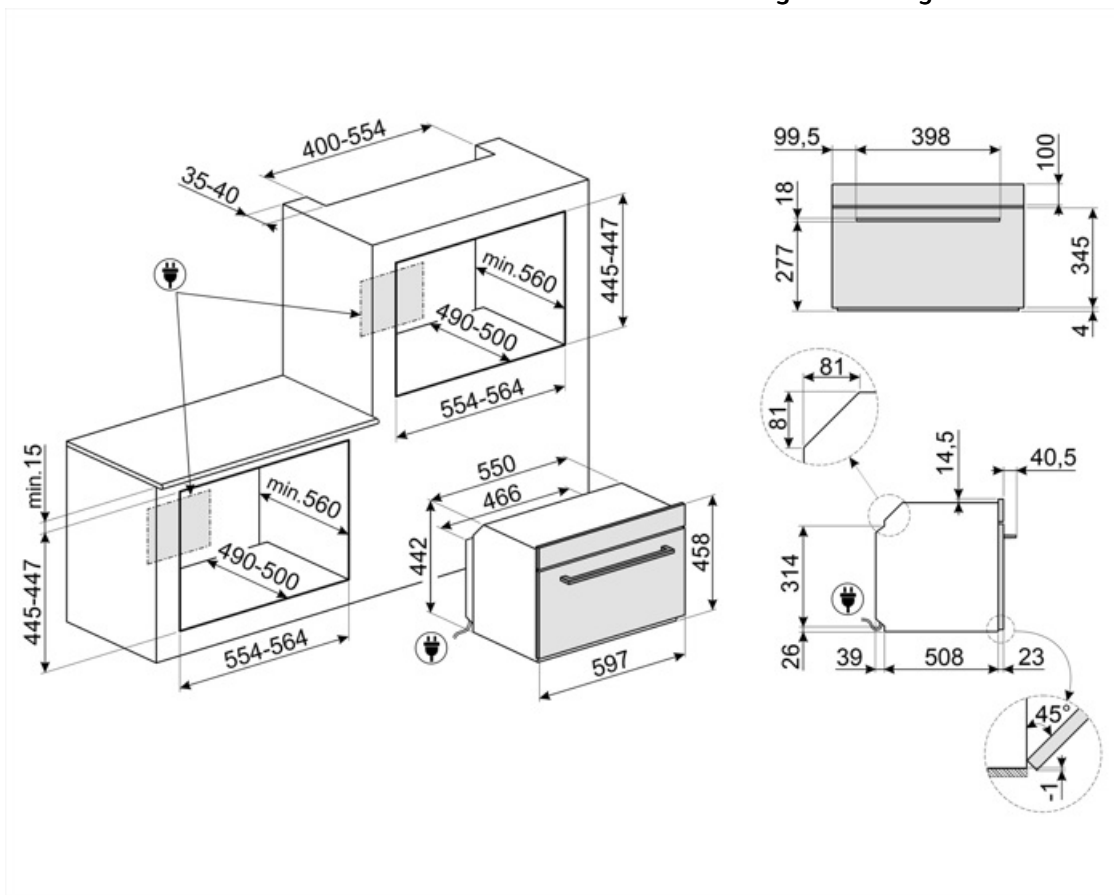

Compatible Accessories

BBQ

Dubbelzijdig



ET50

Geëmailleerde ovenschaal voor 45cm en 60cm ovens. Diepte 50 mm.



STONE2

Rectangular pizza stone without handles, suitable for 45cm and 60cm wide ovens. Dimensions W42 x H1.8 x D37.5cm. Ideal for cooking pizzas with the same results as a typical wood-fired oven. Can also be used for baking bread, focaccias and other recipes such as pies, flans or biscuits



ET20

Geëmailleerde ovenschaal voor 45cm en 60cm ovens. Diepte 20 mm.



GTT2

Volledig uitschuifbare telescopische rails (1 niveau) voor traditionele ovens (SO-)

















Alternative products



SO4204M2PSI

Zilver

Symbols glossary

-  Sommige modellen zijn voorzien van een functie om het programma/de cyclus te blokkeren zodat het niet per ongeluk kan aangepast worden.
-  Air cooling system: to ensure a safe surface temperatures.
-  Defrost by weight: Automatic defrost function. You choose the type of food to defrost from the available categories (MEAT - FISH - BREAD - DESSERTS). After entering the weight of the food, the oven automatically defines the time required for proper defrosting.
-  Automatic lighting deactivation: For greater energy savings, the lighting turns off automatically after one minute from the start of cooking. The option can be disabled via the settings menu. In this case the light will remain on for the entire duration of cooking.
-  Elektrische aansluiting
-  Combination microwave: This oven allows to combine two different ways of cooking (Traditional with microwaves). Combined ovens increase cooking opportunities, while providing maximum flexibility of household appliances.
-  Defrost by time: Manual defrost function. At the end of the set duration, the function stops.
-  Triple glazed doors: Number of glazed doors.
-  ECO-logic: option allows you to restrict the power limit of the appliance real energy saving.
-  Ever Clean Enamel: Ever Clean enamel is applied electrostatically, corner to corner and edge to edge to prevent cracking or cracks over time. It is a particular pyrolytic enamel, resistant to acids which, in addition to being pleasantly bright, promotes greater cleaning of the oven walls, thanks to its lower porosity. It is baked at over 850 °C and slowly polymerized at a scientifically determined rate to ensure uniform depth and strength. Ever Clean enamel creates an impeccable finish both on the inside of the oven and on the trays, making the surfaces of the oven incredibly easy to maintain over time as it reduces the adhesion of fat during cooking.
-  Ventilator met bovenste en onderste elementen: De elementen in combinatie met de ventilator zijn bedoeld om een meer gelijkmatige warmte te bieden, een methode die vergelijkbaar is met conventioneel koken, dus voorverwarmen is vereist. Het meest geschikt voor items die langzaam koken vereisen.
-  Alleen boven- en onder element: een traditionele kookmethode die het meest geschikt is voor losse items in het midden van de oven. de bovenkant van de oven zal altijd het heetst zijn. Ideaal voor gebraden vlees, fruitcake, brood etc.
-  Base: the heat comes only from the bottom of the cavity. The fan is not active. Ideal for sweet and savory pies, cobblers and pizzas. Designed to complete cooking and make food more crunchy. This symbol in gas ovens indicates the gas burner.
-  Circulaire met onderste element: De toevoeging van het onderste element voegt extra warmte toe aan de basis voor voedsel dat extra moet worden gekookt.



Circulaire: De combinatie van de ventilator en het ronde element eromheen zorgt voor een hete lucht kookmethode. Dit biedt vele voordelen, waaronder geen voorverwarmen als de kooktijd meer dan 20 minuten bedraagt, geen smaakoverdracht bij het gelijktijdig bereiden van verschillende soorten voedsel, minder energie en kortere kooktijden. Geschikt voor alle soorten voedsel.



Grill: Very intense heat coming only from above from a double heating element. The fan is not active. Provides excellent grilling and gratinating results. Used at the end of cooking, it gives a uniform browning to dishes.



Microwave: Penetrating straight into the food, microwaves cook very quickly and with considerable energy savings. Suitable for cooking without fat, they are also able to thaw and heat food without altering its original appearance and aroma. The microwave function can also be combined with conventional functions with all the resulting advantages. Ideal for all types of food.



Microwave + grill element: The use of the grill results in a perfect browning of the surface of the food. The action of microwaves allows instead of cooking in a short time the internal part of the food.



This function can reheat precooked dishes, without becoming dry or hard.



Circulaire met bovenste en onderste elementen: door het gebruik van de ventilator met beide elementen kan voedsel snel en effectief worden gekookt, ideaal voor grote stukken vlees die grondig moeten worden gekookt. Het biedt een vergelijkbaar resultaat als rotisserie, waarbij de warmte rond het voedsel wordt verplaatst in plaats van het voedsel zelf te verplaatsen, waardoor elke maat of vorm kan worden gekookt.



Met deze functie kan u bereidingen warmhouden zodat het eten niet meteen afkoelt



Koken met temperatuursonde: het is mogelijk om de temperatuur die herkend is door de sonde weer te geven op het display en een doeltemperatuur voor het gerecht in te stellen. Wanneer het centrum van het gerecht de juiste temperatuur heeft bereikt, stopt de functie.



De combinatie van de grill, de ventilator en onderwarmte is interessant voor het bereiden van kleine hoeveelheden.



Fan grill: very intense heat coming only from above from a double heating element. The fan is active. It allows the optimal grilling of thickest meats. Ideal for large cuts of meat.



Cooking with the simultaneous use of the heating element in combination with fan and microwave supply.



Fan combined with traditional cooking, where heat is generated from above and below, provides uniform heat. Adding the microwave function allows the same cooking results in less time.



Pizza function: Specific function for cooking pizza in a pan. It allows to obtain a pizza that is soft inside and crispy outside with the topping perfectly cooked, not dry and not burnt.



Compacte toestellen met een hoogte van 45 cm - perfecte oplossing om te voldoen aan de functionele eisen van keukensets met een kleine hoogte. Verkrijgbaar in verschillende soorten en in verschillende stijlen.



Plate rack warming: function for heating or keeping dishes warm. Place the baking tray on the lowest shelf and stack the dishes to be heated.



Air at 40°C provides the perfect environment for proving yeast type dough mixes. Simply select the function and place dough in the cavity for allotted

- 

Rapid preheating: cooking is preceded by the preheating phase which allows the cooking compartment to reach the set temperature. This option reduces the time by up to 50%.



SABBATH: function that allows to cook food respecting Judaism's day of rest provisions.
- 

Option designed to solve any doubts More than 100 pop-ups, which can be triggered with a long touch on any icon, provide information on the use of the display and cooking.



The oven cavity has 2 different cooking levels.
- 

Smart Cooking is the perfect recipe for every occasion. Meat, fish, pasta, desserts, etc . up to 150 automatic recipes that allow to make any preparation in a single click. Decide your menu and then the oven takes care of the rest.



Alle modellen zijn voorzien van een soft close deursysteem waarbij de deur zacht en stil sluit.
- 

Telescopic rails: allow you to pull out the dish and check it without having to remove it from the oven entirely.



Electronic control: Allows you to maintain temperature inside the oven with the precision 2-3 ° C. This enables to cook meals that are very sensitive to temperature changes, such as cakes, souffles, puddings.
- 

Tilting grill: the tilting grill can be easily unhooked to move the heating element and clean the roof of the appliance in one simple step.



Bediening met touch knoppen: dankzij de gebruiksvriendelijke aanraakbediening kan het apparaat met één druk op de knop worden geprogrammeerd.
- 

Vapor Clean: a simple cleaning function using steam to loosen deposits in the oven cavity.



The capacity indicates the amount of usable space in the oven cavity in litres.
- 

The capacity indicates the amount of usable space in the oven cavity in litres.



Volledig touch display
- 

Met deze functie kan je alle types gekookt voedsel warmhouden.



INSTANT GO: activating this option allow to start cooking immediately. Preheating is included in the cooking time and the oven will gradually reach the desired temperature Particularly suitable for frozen foods.
- 

Active and controlled microwave distribution. The Microwave Stirrer fan distributes the waves evenly within the oven, reducing the need for a turntable.











De multipoint temperatuursonde heeft drie detectiepunten. Hierdoor wordt niet alleen de kerntemperatuur gedetecteerd, maar ook de temperatuur in andere delen. De oven verwerkt al deze gegevens om ongelijkmatige bereidingen te voorkomen. Op deze manier kan elk product in een professionele restaurantstijl worden gekookt.
- 

De perfecte manier om in een paar simpele stappen een compleet menu te hebben met een flinke tijds winst. De grote ovenruimte biedt plaats aan meerdere soorten voedsel tegelijk, die kunnen worden gekookt zonder geuruitwisseling. De zorgvuldig bestudeerde thermodynamische stromen zorgen voor uniform koken op elk niveau. Het SameTime-algoritme berekent de tijden, de kookfuncties en alle parameters zodat 3 gerechten tegelijk klaar kunnen zijn



The inverter technology allows to generate microwaves continuously and at the desired power. The constant flow, without on and off cycles, allows you to precisely control the temperature, reduce times, avoids wasting energy and allows you to obtain excellent cooking, defrosting and re-heating results, thanks to the smaller difference between core and surface temperature in food.

-
- | | |
|---|--|
|  <p>Speciale kookfunctie voor de dubbelzijdige plaat-BBQ. Geschikt voor het nabootsen van sappige en knapperige gerechten in de oven met de typische smaak van gegrild koken. De geribbelde kant is bijzonder geschikt voor vleeswaren en kazen; de gladde kant voor vis, zeevruchten en groenten.</p> |  <p>Speciale kookfunctie voor het Airfryerrek AIRFRY. Ideaal voor het nabootsen van traditioneel frituren in de oven, maar met minder calorieën en minder vet. Hiermee kook je snel en eenvoudig gerechten zoals frites, gebakken groenten en vis, waardoor ze perfect bruin en krokant worden.</p> |
|  <p>Speciale kookfunctie voor de pizzasteen STONE. Ideaal voor het bakken van pizza's met hetzelfde resultaat als een typische houtgestookte oven. Kan ook worden gebruikt voor het bakken van brood, focaccia's en andere recepten zoals taarten, vlaaien of koekjes</p> |  <p>The double chimney technology create a special airflow inside the cavity that reduce the consensation inside the cavity during microwave cooking, where the cavity is cold and the food is warm</p> |
|  <p>DeltaT cooking The oven automatically sets the cavity temperature to a predefined temperature (named deltaT) higher than the core temperature detected by the probe. When the probe detects an extra degree at the core, the oven automatically increases also its internal temperature by one degree. The oven offers the possibility to choose between three different deltaT cooking modes (slow, medium and fast) and to set any desired core temperature. A concentration of technology that makes it possible to obtain tender, juicy, healthy products of the highest quality.</p> |  <p>Function to melt butter and chocolate without using the bain-marie</p> |
|  <p>Function to soften butter and cheese It is useful for quickly bringing frozen desserts to serving temperature The function can also be used to soften ice cream</p> |  <p>Function for the preparation of popcorn packaged in bags</p> |