

SO4301M0N

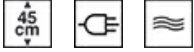

Category	45cm Compact Ovens
Product Family	Oven
Power supply	Electric
Heat source	Electric
Cooking method	Microwave with grill
Galileo cavity	Micro + grill
EAN code	8017709315542



Aesthetics

Aesthetics	Classic	Serigraphy type	Symbols
Colour	Matte Black	Door	With 2 horizontal strips
Finishing	Matte	Handle	Classic
Design	Flat	Handle Colour	Black
Material	Stainless steel	Logo	Embossed
Type of steel	Brushed	Control knobs	Classic
Glass Type	Eclipse	Controls colour	Black
Serigraphy colour	Silver		

Controls

Display name	CompactScreen	Control setting	Control knobs
Display technology	LCD	No. of controls	2

Programs / Functions

No. of cooking functions 4
 Traditional cooking functions



Microwave functions

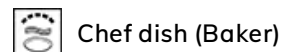

Other functions

 Defrost by time

Options



Time-setting options	Delay start and automatic end cooking	Controls Lock / Child Safety	Yes
Minute minder	Yes	Other options	
Timer	1	Showroom demo option	Yes

Technical Features



Capacity (Lt)	40 l	Door opening type	Standard opening
Cavity	QS-Galileo	Door	Temperate door
Minimum Temperature	30 °C	Total no. of door glasses	3
Maximum temperature	250 °C	Microwave stops when door is opened	Yes
Shelf positions	2	Cooling system	Tangential
No. of lights	1	Cooling duct	Single
Light type	Halogen	Usable cavity space dimensions (HxWxD)	212x462x407 mm
Light power	40 W	Temperature control	Electronic
Light when door is opened	Yes	Cavity material	Easy clean enamel
Grill element - power	1500 W	Microwave screen protection	Yes
Heating suspended when door is opened	Yes		

Performance / Energy Label



Net volume of the cavity	40 litres	Microwave effective power	800 W
Number of cavities	1		

Accessories Included

Chrome shelf 1

Electrical Connection

Voltage	220-240 V	Nominal power (W)	3000 W
Plug	No	Frequency (Hz)	50 Hz
Current	13 A	Power supply cable length	150 cm

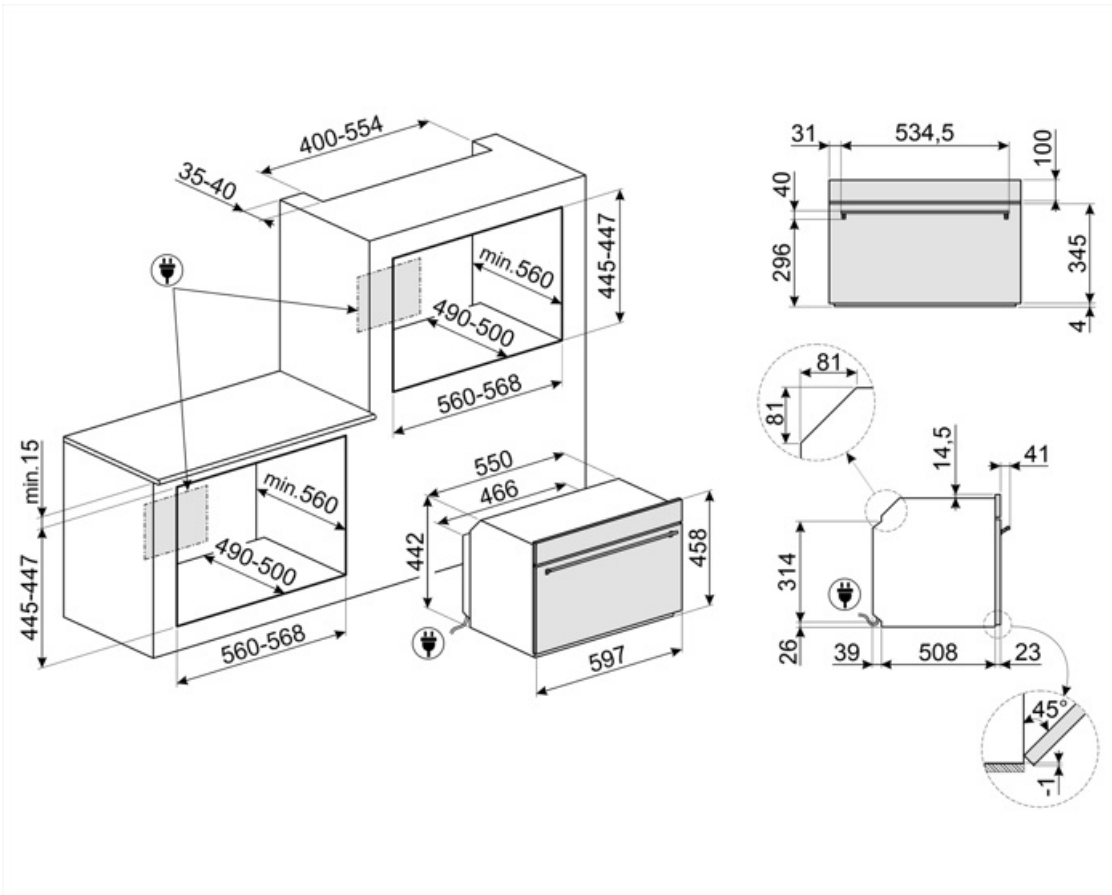

Compatible Accessories

BBQ

Double sided plate BBQ. Suitable for recreating succulent and crispy dishes in the oven with the typical taste of grilled cooking. The ribbed side is particularly suitable for meats and cheeses. The smooth side for fish, seafood and vegetables.



ET20

Enamelled tray, 20mm deep



ET50

Enamelled tray, 50mm deep





















STONE2

Rectangular pizza stone without handles, suitable for 45cm and 60cm wide ovens. Dimensions W42 x H1.8 x D37.5cm. Ideal for cooking pizzas with the same results as a typical wood-fired oven. Can also be used for baking bread, focaccias and other recipes such as pies, flans or biscuits



Symbols glossary

 <p>Child lock: some models are fitted with a device to lock the programme/cycle so it cannot be accidentally changed.</p>	 <p>Microwave energy shortens cooking times dramatically and produces energy savings.</p>
 <p>Air cooling system: to ensure a safe surface temperatures.</p>	 <p>Defrost by time: with this function the time of thawing of foods are determined automatically.</p>
 <p>Triple glazed doors: Number of glazed doors.</p>	 <p>Electric</p>
 <p>Enamel interior: The enamel interior of all Smeg ovens have a special antacid lining which helps keep the interior clean by reducing the amount of cooking grease adhering to it.</p>	 <p>Crisper: The simultaneous operation of the microwave, grill and crisper plate (once pre-heated) allows the food to go crispy and golden, ideal for cooking Pizza etc</p>
 <p>Grill element: Using of grill gives excellent results when cooking meat of medium and small portions, especially when combined with a rotisserie (where possible). Also ideal for cooking sausages and bacon.</p>	 <p>Microwave: Penetrating straight into the food, microwaves cook very quickly and with considerable energy savings. Suitable for cooking without fat, they are also able to thaw and heat food without altering its original appearance and aroma. The microwave function can also be combined with conventional functions with all the resulting advantages. Ideal for all types of food.</p>
 <p>Microwave + grill element: The use of the grill results in a perfect browning of the surface of the food. The action of microwaves allows instead of cooking in a short time the internal part of the food.</p>	 <p>Compact appliances with a height of 45 cm - perfect solution to meet the functional requirements of kitchen sets of small height. Available in several types and in different styles.</p>
 <p>Side lights: Two opposing side lights increase visibility inside the oven.</p>	 <p>The oven cavity has 2 different cooking levels.</p>
 <p>Electronic control: Allows you to maintain temperature inside the oven with the precision 2-3 ° C. This enables to cook meals that are very sensitive to temperature changes, such as cakes, souffles, puddings.</p>	 <p>Tilting grill: the tilting grill can be easily unhooked to move the heating element and clean the roof of the appliance in one simple step.</p>
 <p>The capacity indicates the amount of usable space in the oven cavity in litres.</p>	 <p>The capacity indicates the amount of usable space in the oven cavity in litres.</p>
 <p>With a simple and intuitive interface, the COMPACTscreen provides a pleasant user experience, thanks to the interaction with the knobs.</p>	