

# SO4301M0N



<b>Categorie</b>	45 cm
<b>Familie</b>	Oven
<b>Voeding</b>	Elektrisch
<b>Warmte bron</b>	Elektrisch
<b>Bereidingswijze</b>	Magnetron met grill
<b>Technologie</b>	Micro + grill
<b>EAN-code</b>	8017709315542



## Design

<b>Esthetiek</b>	Classici	<b>Type zeefdruk</b>	Symbolen
<b>Kleur</b>	Matt Black	<b>Deur</b>	Met 2 horizontale stroken
<b>Afwerking</b>	Mat	<b>Handgreep</b>	Classici
<b>Design</b>	Plat	<b>Kleur handgreep</b>	Zwart
<b>Materiaal</b>	Roestvrij staal	<b>Logo</b>	In reliëf
<b>Type roestvrijstaal</b>	Geborsteld	<b>Bedieningsknoppen</b>	Classici
<b>Type glas</b>	Zwart	<b>Kleur knoppen</b>	Zwart
<b>Kleur serigrafie</b>	Zilver		

## Bediening

			
<b>Naam display</b>	CompactScreen	<b>Regeling bediening</b>	Bedieningsknoppen
<b>Display technologie</b>	LCD	<b>Aantal bedieningsknoppen</b>	2

## Programma's / functies

<b>Aantal kookfuncties</b>	4
<b>Personaliseerbare recepten</b>	No
<b>Traditionele kookfuncties</b>	

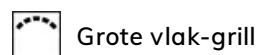

Grote vlak-grill

## Bereidingsfuncties met microgolven

 Magnetron	 Magnetron met grill	 Chef dish (Baker)
--	---	---

## Overige functies

 Ontdooien op tijd
--

## Opties



<b>Opties tijdprogrammering</b>	Automatische in- en uitschakeling	<b>Kinderbeveiliging</b>	Ja
<b>Timer</b>	Ja	<b>Overige opties</b>	
<b>Timer</b>	1	<b>Showroom demo optie</b>	Ja

## Technische specificaties



<b>Inhoud (l)</b>	<50 l	<b>Deur openen</b>	Standaard opening
<b>Cavity</b>	QS-Galileo	<b>Deur</b>	Temperatuur gecontroleerde deur
<b>Minimum temperatuur</b>	30 °C	<b>Totaal aantal ruiten</b>	3
<b>Maximum temperatuur</b>	250 °C	<b>Automatische uitschakeling magnetron bij openen deur</b>	Ja
<b>Aantal kookniveaus</b>	2	<b>Koelsysteem</b>	Mantelkoeling
<b>Aantal lampen</b>	1	<b>Koelleiding</b>	Enkel
<b>Soort verlichting</b>	Halogeen	<b>Afmetingen bruikbare interne ovenruimte (hxbxd)</b>	212x462x407 mm
<b>Vermogen lamp</b>	40 W	<b>Temperatuurregeling</b>	Elektronisch
<b>Automatische inschakeling verlichting bij openen deur</b>	Ja	<b>Materiaal ovenruimte</b>	Ever Clean emaille
<b>Grill - vermogen</b>	1500 W	<b>Veiligheidsscherm magnetrondeur</b>	Ja
<b>Automatische uitschakeling verhittingselementen bij openen deur</b>	Ja		

## Prestaties / energielabel



<b>Netto inhoud</b>	40 l	<b>Effectief magnetronvermogen</b>	800 W
<b>Aantal ovens</b>	1		

## Meegeleverde accessoires

<b>Ovenrooster met stop</b>	1
-----------------------------	---

## Elektrische aansluiting

<b>Spanning</b>	220-240 V	<b>Nominale aansluitwaarde</b>	3000 W
<b>Stekker</b>	Nee	<b>Frequentie</b>	50 Hz
<b>Stroom</b>	13 A	<b>Lengte voedingskabel</b>	150 cm

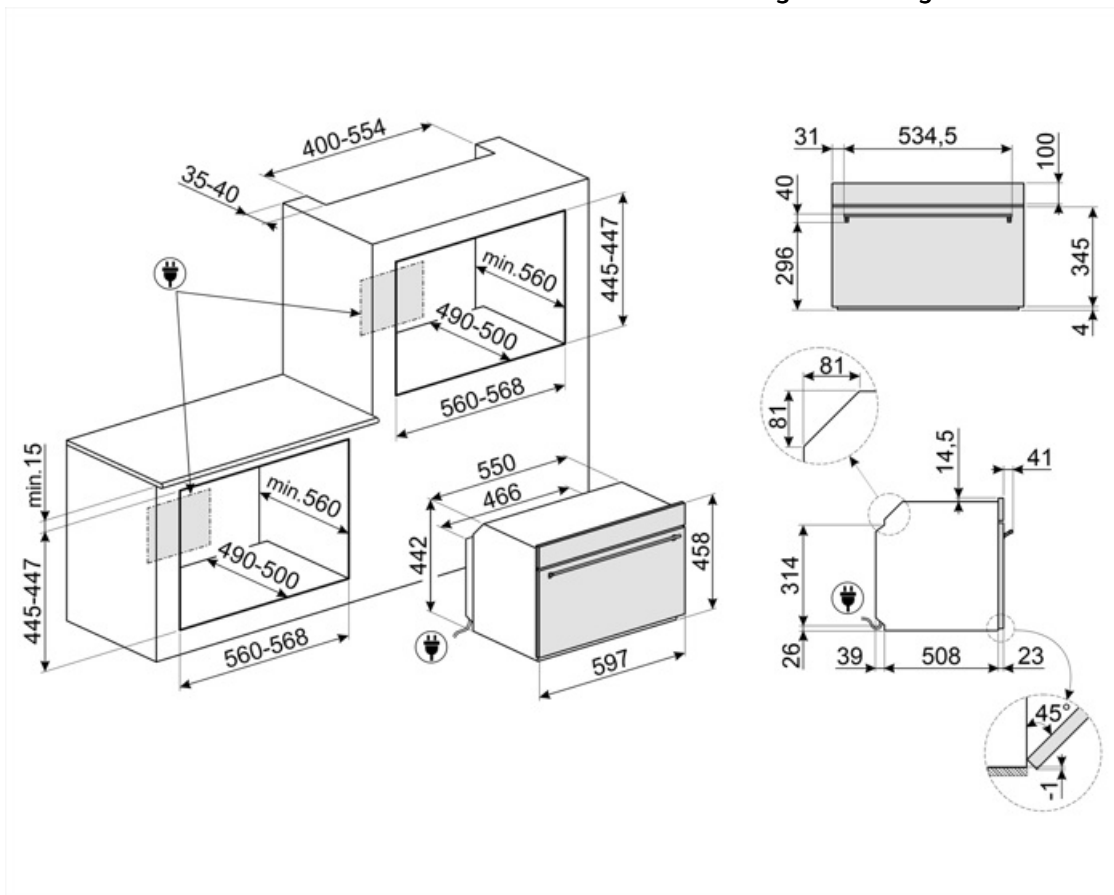

---

## Compatibele Accessoires

---

### BBQ

Dubbelzijdig



### ET20

Geëmailleerde bakplaat, 20 mm diep



### ET50

Geëmailleerde bakplaat, 50 mm diep





















### STONE2

Rectangular pizza stone without handles, suitable for 45cm and 60cm wide ovens. Dimensions W42 x H1.8 x D37.5cm. Ideal for cooking pizzas with the same results as a typical wood-fired oven. Can also be used for baking bread, focaccias and other recipes such as pies, flans or biscuits



## Symbols glossary

 <p>Kinderslot: sommige modellen zijn voorzien van een apparaat om het programma / de cyclus te vergrendelen zodat het niet kan per ongeluk veranderd</p>	 <p>Microwave energy shortens cooking times dramatically and produces energy savings.</p>
 <p>Luchtkoelsysteem: om een veilig oppervlak te garanderen temperaturen.</p>	 <p>Ontdooien op tijd: met deze functie wordt automatisch het tijdstip van ontdooien van voedsel bepaald</p>
 <p>Deuren met driedubbele beglazing: aantal glazen deuren.</p>	 <p>Electric</p>
 <p>Geëmailleerde binnenkant: De geëmailleerde binnenkant van alle Smeg-ovens heeft een speciale antacidumvoering die helpt om de binnenkant schoon te houden door de hoeveelheid kookvet te verminderen.</p>	 <p>Crisper: The simultaneous operation of the microwave, grill and crisper plate (once pre-heated) allows the food to go crispy and golden, ideal for cooking Pizza etc.</p>
 <p>De warmte wordt geproduceerd door het grill- en bovinelement. Verhitting over het volledige oppervlak. De thermostaat wordt, afhankelijk van het gerecht, in de regel op de maximale stand gezet. Bij een korte baktijd kan de ovendeur gesloten blijven; bij langere baktijd blijft deze gedeeltelijk geopend. Voor vleesgerechten (klein- en middelgroot), vleespennen, vis, groenten, gratineren etc.</p>	 <p>Microwave: Penetrating straight into the food, microwaves cook very quickly and with considerable energy savings. Suitable for cooking without fat, they are also able to thaw and heat food without altering its original appearance and aroma. The microwave function can also be combined with conventional functions with all the resulting advantages. Ideal for all types of food.</p>
 <p>Microwave + grill element: The use of the grill results in a perfect browning of the surface of the food. The action of microwaves allows instead of cooking in a short time the internal part of the food.</p>	 <p>Compact appliances with a height of 45 cm - perfect solution to meet the functional requirements of kitchen sets of small height. Available in several types and in different styles.</p>
 <p>verlichting</p>	 <p>The oven cavity has 2 different cooking levels.</p>
 <p>Electronic control: Allows you to maintain temperature inside the oven with the precision 2-3 ° C. This enables to cook meals that are very sensitive to temperature changes, such as cakes, souffles, puddings.</p>	 <p>Tilting grill: the tilting grill can be easily unhooked to move the heating element and clean the roof of the appliance in one simple step.</p>
 <p>The capacity indicates the amount of usable space in the oven cavity in litres.</p>	 <p>The capacity indicates the amount of usable space in the oven cavity in litres.</p>
 <p>With a simple and intuitive interface, the COMPACTscreen provides a pleasant user experience, thanks to the interaction with the knobs.</p>	