

# SO4301M0X



Category	45 cm
Product Family	Oven
Power supply	Electric
Heat source	ELECTRICITY
Cooking method	Microwave with grill
Galileo platform	Micro + grill
Cleaning system	Ever Clean enamel
EAN code	8017709299804



## Aesthetics

Aesthetic	Classica	Serigraphy colour	Black
Colour	Stainless steel	Serigraphy type	Symbols
Finishing	Fingerproof	Door	With 2 horizontal strips
Design	Flat	Handle	Classic
Material	Stainless steel	Handle Colour	Inox
Type of steel	Brushed	Logo	Embossed
Glass Type	Eclipse	Control knobs	Classic

## Controls



Display name	CompactScreen	Control setting	Knobs
Display technology	LCD	No. of controls	2

## Programs / Functions

No. of cooking functions 4  
 Traditional cooking functions



Microwave functions

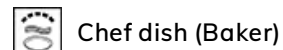

## Other functions

 Defrost by time

## Options



<b>Time-setting options</b>	Delay start and automatic end cooking	<b>Controls Lock / Child Safety</b>	Yes
<b>Minute minder</b>	Yes	<b>Other options</b>	
<b>Timer</b>	1	<b>Showroom demo option</b>	Yes

## Technical Features



<b>Capacity (Lt)</b>	<50 l	<b>Door opening type</b>	Standard opening
<b>Cavity</b>	QS-Galileo	<b>Door</b>	Temperate door
<b>Minimum Temperature</b>	30 °C	<b>Total no. of door glasses</b>	3
<b>Maximum temperature</b>	250 °C	<b>Microwave stops when door is opened</b>	Yes
<b>No. of shelves</b>	2	<b>Chimney</b>	Fixed
<b>No. of lights</b>	1	<b>Cooling system</b>	Tangential
<b>Light type</b>	Halogen	<b>Cooling duct</b>	Single
<b>Light Power</b>	40 W	<b>Usable cavity space dimensions (HxWxD)</b>	240x462x401 mm
<b>Light when door is opened</b>	Yes	<b>Temperature control</b>	Electronic
<b>Grill element - power</b>	1500 W	<b>Cavity material</b>	Ever clean Enamel
<b>Heating suspended when door is opened</b>	Yes	<b>Microwave screen protection</b>	Yes

## Performance / Energy Label



<b>Net volume of the cavity</b>	40 l	<b>Microwave effective power</b>	800 W
<b>Number of cavities</b>	1		

## Accessories Included

**Rack with back stop (concave)** 1

## Electrical Connection

<b>Voltage</b>	220-240 V	<b>Nominal power</b>	3000 W
<b>Plug</b>	Not present	<b>Frequency (Hz)</b>	50 Hz
<b>Current</b>	13 A		

Power supply cable length 150 cm

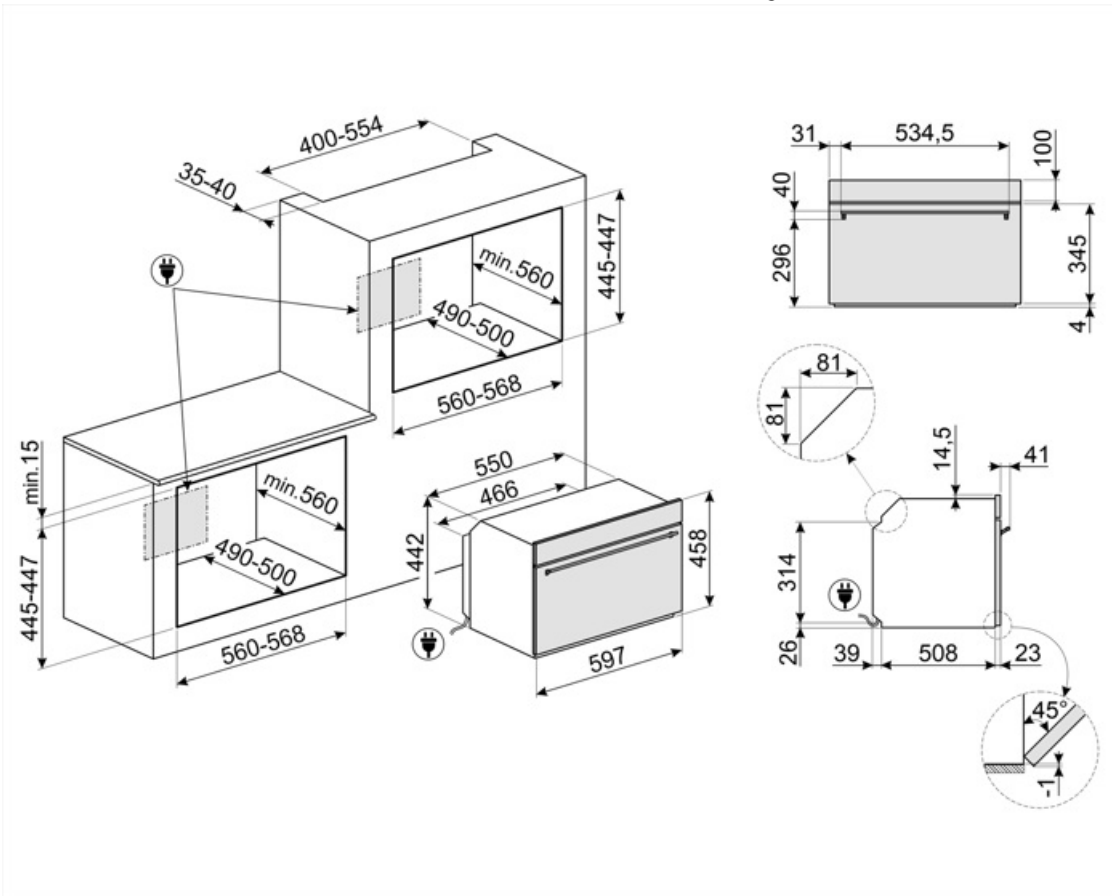

---

## Compatible Accessories

---

### BBQ

Double sided plate BBQ. Suitable for recreating succulent and crispy dishes in the oven with the typical taste of grilled cooking. The ribbed side is particularly suitable for meats and cheeses. The smooth side for fish, seafood and vegetables.



### ET50

Enamelled tray suitable for 45cm and 60cm ovens. Depth 50 mm. Perfect for cooking and roasting meat and fish in sauces. Also ideal for experimenting with lighter and crunchy side dishes



### ET20

Enamelled tray suitable for 45cm and 60cm ovens. Depth 20 mm. Perfect for a wide range of savoury and sweet baking.





















### STONE2

Rectangular pizza stone without handles, suitable for 45cm and 60cm wide ovens. Dimensions W42 x H1.8 x D37.5cm. Ideal for cooking pizzas with the same results as a typical wood-fired oven. Can also be used for baking bread, focaccias and other recipes such as pies, flans or biscuits



## Symbols glossary

 <p>Child lock: some models are fitted with a device to lock the programme/cycle so it cannot be accidentally changed.</p>	 <p>Microwave energy shortens cooking times dramatically and produces energy savings.</p>
 <p>Air cooling system: to ensure a safe surface temperatures.</p>	 <p>Defrost by time: Manual defrost function. At the end of the set duration, the function stops.</p>
 <p>Triple glazed doors: Number of glazed doors.</p>	 <p>Electric</p>
 <p>Ever Clean Enamel: Ever Clean enamel is applied electrostatically, corner to corner and edge to edge to prevent cracking or cracks over time. It is a particular pyrolytic enamel, resistant to acids which, in addition to being pleasantly bright, promotes greater cleaning of the oven walls, thanks to its lower porosity. It is baked at over 850 ° C and slowly polymerized at a scientifically determined rate to ensure uniform depth and strength Ever Clean enamel creates an impeccable finish both on the inside of the oven and on the trays, making the surfaces of the oven incredibly easy to maintain over time as it reduces the adhesion of fat during cooking</p>	 <p>Crisper: The simultaneous operation of the microwave, grill and crisper plate (once pre-heated) allows the food to go crispy and golden, ideal for cooking Pizza etc</p>
 <p>Grill: Very intense heat coming only from above from a double heating element. The fan is not active. Provides excellent grilling and gratinating results. Used at the end of cooking, it gives a uniform browning to dishes.</p>	 <p>Microwave: Penetrating straight into the food, microwaves cook very quickly and with considerable energy savings. Suitable for cooking without fat, they are also able to thaw and heat food without altering its original appearance and aroma. The microwave function can also be combined with conventional functions with all the resulting advantages. Ideal for all types of food.</p>
 <p>Microwave + grill element: The use of the grill results in a perfect browning of the surface of the food. The action of microwaves allows instead of cooking in a short time the internal part of the food.</p>	 <p>Compact appliances with a height of 45 cm - perfect solution to meet the functional requirements of kitchen sets of small height. Available in several types and in different styles.</p>
 <p>Side lights: Two opposing side lights increase visibility inside the oven.</p>	 <p>The oven cavity has 2 different cooking levels.</p>
 <p>Electronic control: Allows you to maintain temperature inside the oven with the precision 2-3 ° C. This enables to cook meals that are very sensitive to temperature changes, such as cakes, souffles, puddings.</p>	 <p>Tilting grill: the tilting grill can be easily unhooked to move the heating element and clean the roof of the appliance in one simple step.</p>
 <p>The capacity indicates the amount of usable space in the oven cavity in litres.</p>	 <p>The capacity indicates the amount of usable space in the oven cavity in litres.</p>
 <p>With a simple and intuitive interface, the COMPACTscreen provides a pleasant user experience, thanks to the interaction with the knobs.</p>	