

SO4301M0X

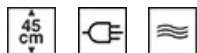

Categorie	45 cm
Product familie	Oven
Stroomvoorziening	Elektrisch
Warmtebron	Elektriciteit
Bereidingswijze	Microgolf met grill
Galileo technologie	Micro + grill
EAN-code	8017709299804



Design

Design	Classici	Kleur serigrafie	Zwart
Kleur	Inox	Type zeefdruk	Symbolen
Afwerking	Fingerproof	Deur	Met 2 horizontale stroken
Design	Plat	Handvat	Classici
Materiaal	Inox	Kleur handvat	Inox
Type roestvrijstaal	Geborsteld inox	Logo	In reliëf
Type glas	Eclipse zwart glas	Bedieningsknoppen	Classici

Bediening

			
Display	CompactScreen	Bediening	Bedieningsknoppen
Display	LCD	Aantal bedieningsknoppen	2

Programma's / Functies

Aantal kookfuncties	4
Individualiseerbare recepten	No
Traditionele bereidingsfuncties	



Grote grill

Bereidingsfuncties met microgolven



Microgolfoven



Microgolf + grill



Crisp

Overige functies



Ontdooien op tijd

Opties



Tijdsinstelling	Automatische in- en uitschakeling	Kinderbeveiliging	Ja
Timer	Ja	Andere opties	
Timer	1	Showroom demo optie	Ja

Technische specificaties



Minimum temperatuur	50 °C	Deur	Temperatuur gecontroleerde deur
Maximum temperatuur	250 °C	Totaal aantal ruiten	3
Aantal kookniveaus	2	Automatische uitschakeling microgolf bij openen deur	Ja
Aantal lampen	1	Chimney	Fixed
Type lamp	Halogeen	Koelsysteem	Mantelkoeling
Vermogen lamp	40 W	Koelleiding	Enkel
Verlichting bij opening deur	Ja	Afmetingen bruikbare interne ovenruimte (hxbxd)	240x462x401 mm
Grill - vermogen	1500 W	Temperatuurcontrole	Elektronisch
Warmte onderbroken bij openen deur	Ja	Materiaal ovenruimte	Ever Clean emaille
Opening deur	Standaard opening	Veiligheidsscherm microgolfdeur	Ja

Prestaties / energielabel



Netto volume	40 l	Effectief vermogen microgolf	800 W
Aantal ovens	1		

Meegeleverde accessoires

Ovenrooster met stop	1
----------------------	---







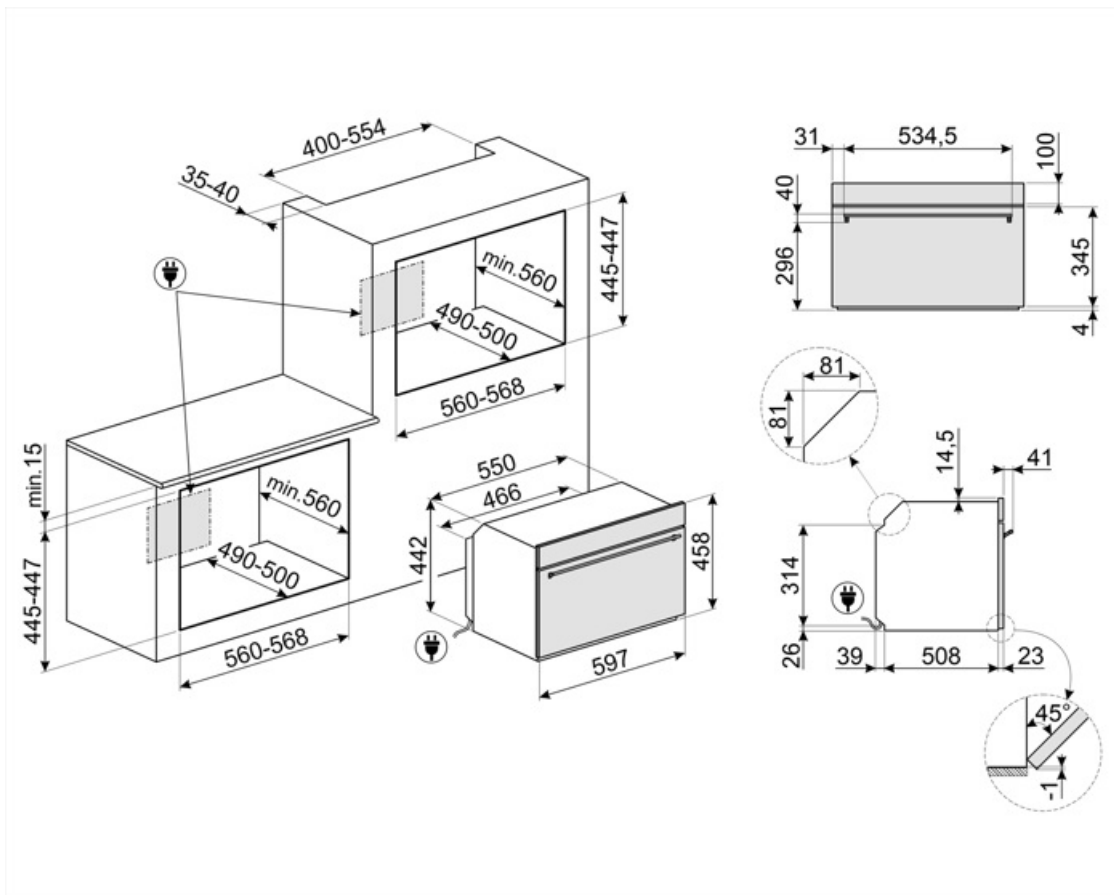











Elektrische aansluiting

Spanning 220-240 V
 Stroom 13 A
 Nominale aansluitwaarde 3000 W

Frequentie 50 Hz
 Lengte voedingskabel 150 cm



Symbols glossary

 <p>Sommige modellen zijn voorzien van een functie om het programma/de cyclus te blokkeren zodat het niet per ongeluk kan aangepast worden.</p>	 <p>Microwave energy shortens cooking times dramatically and produces energy savings.</p>
 <p>Air cooling system: to ensure a safe surface temperatures.</p>	 <p>Defrost by time: Manual defrost function. At the end of the set duration, the function stops.</p>
 <p>Triple glazed doors: Number of glazed doors.</p>	 <p>Elektrische aansluiting</p>
 <p>Ever Clean Enamel: Ever Clean enamel is applied electrostatically, corner to corner and edge to edge to prevent cracking or cracks over time. It is a particular pyrolytic enamel, resistant to acids which, in addition to being pleasantly bright, promotes greater cleaning of the oven walls, thanks to its lower porosity. It is baked at over 850 ° C and slowly polymerized at a scientifically determined rate to ensure uniform depth and strength Ever Clean enamel creates an impeccable finish both on the inside of the oven and on the trays, making the surfaces of the oven incredibly easy to maintain over time as it reduces the adhesion of fat during cooking</p>	 <p>Crisper: The simultaneous operation of the microwave, grill and crisper plate (once pre-heated) allows the food to go crispy and golden, ideal for cooking Pizza etc</p>
 <p>Grill: Very intense heat coming only from above from a double heating element. The fan is not active. Provides excellent grilling and gratinating results. Used at the end of cooking, it gives a uniform browning to dishes.</p>	 <p>Microwave: Penetrating straight into the food, microwaves cook very quickly and with considerable energy savings. Suitable for cooking without fat, they are also able to thaw and heat food without altering its original appearance and aroma. The microwave function can also be combined with conventional functions with all the resulting advantages. Ideal for all types of food.</p>
 <p>Microwave + grill element: The use of the grill results in a perfect browning of the surface of the food. The action of microwaves allows instead of cooking in a short time the internal part of the food.</p>	 <p>Compacte toestellen met een hoogte van 45 cm - perfecte oplossing om te voldoen aan de functionele eisen van keukensets met een kleine hoogte. Verkrijgbaar in verschillende soorten en in verschillende stijlen.</p>
 <p>Side lights: Two opposing side lights increase visibility inside the oven.</p>	 <p>The oven cavity has 2 different cooking levels.</p>
 <p>Electronic control: Allows you to maintain temperature inside the oven with the precision 2-3 ° C. This enables to cook meals that are very sensitive to temperature changes, such as cakes, souffles, puddings.</p>	 <p>Tilting grill: the tilting grill can be easily unhooked to move the heating element and clean the roof of the appliance in one simple step.</p>
 <p>The capacity indicates the amount of usable space in the oven cavity in litres.</p>	 <p>The capacity indicates the amount of usable space in the oven cavity in litres.</p>
 <p>COMPACTscreen display + bedieningsknoppen</p>	