

SO4606WAPNR



Categorie	45 cm
Product familie	Oven
Vitality system	Ja
Stroomvoorziening	Elektrisch
Warmtebron	Elektriciteit
Bereidingswijze	Multitech
Galileo technologie	Omnichef
Reinigingsysteem	Vapor Clean reiniging
EAN-code	8017709302511



Design

Design	Dolce Stil Novo	Type glas	Eclipse zwart glas
Kleur	Zwart	Deur	Geheel glas
Afwerking	Glanzend	Handvat	Dolce Stil Novo
Design	Plat	Kleur handvat	Zwart
Afwerking componenten	Koper afwerking	Logo	Geassembleerd
Materiaal	Glas		

Bediening

			
Display	VivoScreen max	Aantal talen display	20
Display	Touch display	Display talen	Italiano, English (UK), Français (FR), Français (CA), Nederlands, Español (ES), Español (MX), Português (PT), Svenska, Русский, Deutsch (DE), Dansk, Norsk, Polski, English (AU), Suomi, Ukrainian, Kazakh, Afrikaans (ZA), Zulu (ZA)
Bediening	Geavanceerde touch display		

Programma's / Functies

Aantal kookfuncties	26
Automatische programma's	150
Levels stoompulsen	3 + manual

**Individualiseerbare recepten
Traditionele bereidingsfuncties**

10



Statisch



Statisch + ventilator



Circulatie (ventilator + circulaire)



Turbo: ventilator + circulaire +
statisch



ECO



Grote grill



Ventilator + grote grill



Onderwarmte



Circulaire + onderwarmte



Pizza

Functies met stoempulsen



Statisch + ventilator met
stoempulsen



Circulaire + onderwarmte +
stoempulsen



Circulaire + stoempulsen



Turbo + stoempulsen



Ventilator + grill + stoempulsen

Bereidingsfuncties met stoom



Stoom



Stoom + onder-en bovenwarmte +
ventilator



Stoom + circulaire + ventilator

Circulaire + onderwarmte



Sous-vide

Andere stoomfuncties



Reiniging reservoir



Water afvoer







Water toevoer



Ontkalking

Bereidingsfuncties met microgolven

 Microgolfoven	 Microgolf + boven- en onderwarmte + ventilator	 Microgolf + circulaire + ventilator
 Microgolf + grill	Microgolf + Circulaire + Onderwarmte	

Bereidingsfuncties met microgolven

Multitech

Twintech

Overige functies

 Ontdooien op tijd	 Ontdooien op gewicht	 Rijzen
 Stone cooking	 BBQ	 Air-Fry
 Melt	 Soft	 Pop-corn
 Warmhouden	 Bordenwarmfunctie	 Sabbath

Reinigingsfuncties

 Vapor Clean reiniging
--

Opties



Tijdsinstelling	Automatische in- en uitschakeling	Same Time cooking	Ja
Timer	Ja	DeltaT cooking	Ja
Timer	3	Showroom demo optie	Ja
Kinderbeveiliging	Ja	Begeleide demo functie	Ja
Andere opties	Warmhoudfunctie, Eco light, Taalinstelling, Weergave digitale klok, Geluiden, Helderheid, Volume geluiden	Snelgids	Ja
		Chronologie	Ja, de 10 laatst gebruikte functies
		Snel voorverwarmen	Ja
Koken met temperatuursonde	Ja	Instant GO	Ja

Multi-step cooking	Tot 3 stappen instelbaar
Smart cooking	Ja

Technische specificaties



Inhoud (l)	40 l	Volledig glazen binnendeur	Ja
Cavity	QS-Galileo	Totaal aantal ruiten	4
Minimum temperatuur	25 °C	Soft Close scharnieren	Ja
Maximum temperatuur	250 °C	Soft open & close scharnieren	Ja
Aantal kookniveaus	2	Inverter technologie	Ja
Dubbele ventilator	1	Stirrer	Ja
Aantal lampen	1	Chimney	Double
Type lamp	LED	Koelsysteem	Centrifugal
Vermogen lamp	3 W	Koelleiding	Dubbel
Verlichting bij opening deur	Ja	Reductie snelheid koelsysteem	Ja
Onderwarmte - vermogen	1200 W	Deurblokkering tijdens pyrolyse	Ja
Bovenwarmte - vermogen	1000 W	Hoeveelheid stoom	20 - 100%
Grill - vermogen	1700 W	Afmetingen bruikbare interne ovenruimte (hxbxd)	214x462x397 mm
Grote vlakgrill - vermogen	2700 W	Temperatuurcontrole	Elektronisch
Circulatie - vermogen	1400 W	Materiaal ovenruimte	Ever Clean emaille
Warmte onderbroken bij openen deur	Ja	Water toevoer	Automatische Fill & Hide
Opening deur	Standaard opening	Capaciteit reservoir	2 l
Deur	Koud		

Prestaties / energielabel



Netto volume	40 l	Effectief vermogen microgolf	900 W
Aantal ovens	1		

Meegeleverde accessoires



Ovenrooster met stop	1	Diepe geperforeerde inox ovenschaal (40 mm)	1
Geëmailleerde diepe ovenschaal (50 mm)	1	Glazen ovenplaat	1
Inzetrooster	1	Telescopische geleiders, volledig uitschuifbaar	1
Inox ovenschaal (20 mm)	1	Temperatuur sonde	Ja, driepunt temperatuursonde

Elektrische aansluiting

Spanning	220-240 V	Nominale aansluitwaarde	3000 W
Stekker	Nee	Frequentie	50/60 Hz
Stroom	13 A	Lengte voedingskabel	150 cm

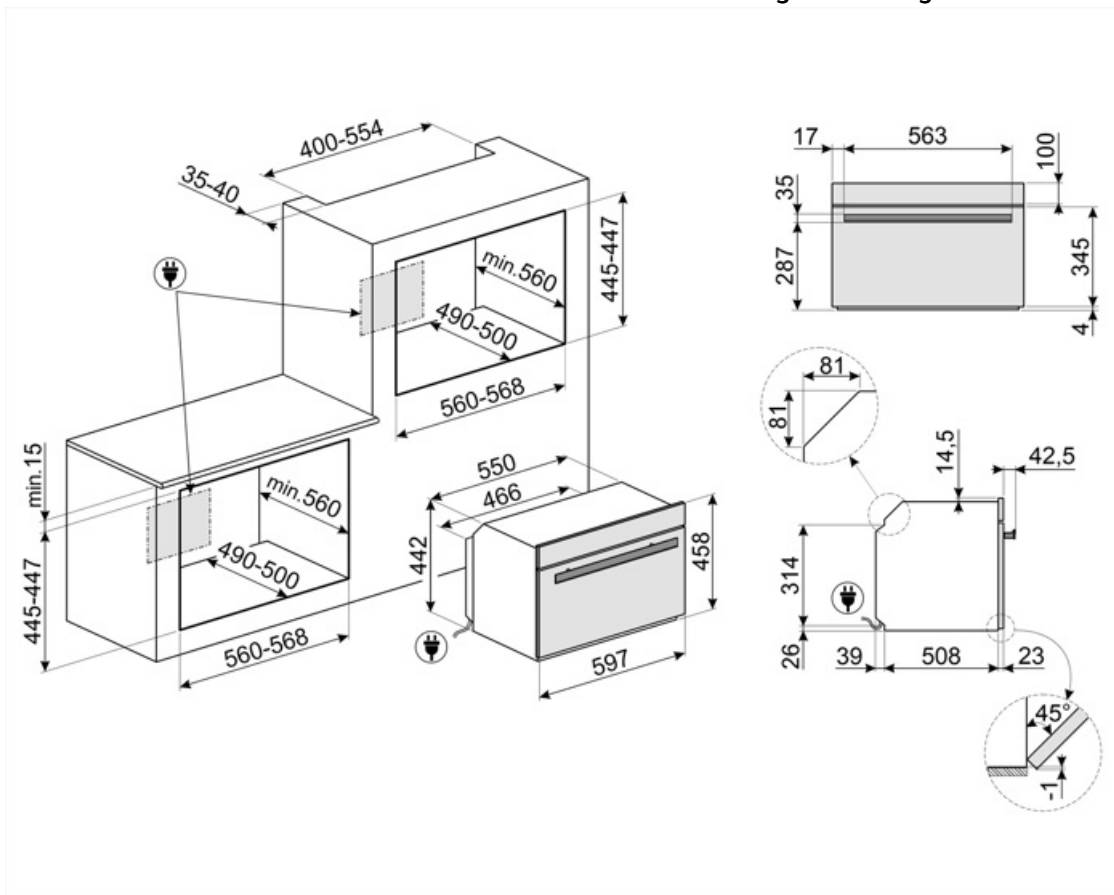

Compatible Accessories

AIRFRY



BBQ

Dubbelzijdig



BN640

Enamelled tray suitable for 45cm and 60cm ovens. Depth 540 mm. Perfect for cooking and roasting meat and fish in sauces. Also ideal for experimenting with lighter and crunchy side dishes



ET20

Geëmailleerde ovenschaal voor 45cm en 60cm ovens. Diepte 20 mm.



GTP2

Partially extractable telescopic guides (1 level), suitable for traditional ovens. Made in stainless steel, they guarantee stability and facilitate the smooth extraction of the trays.



GTTV2

Volledig uitschuifbare telescopische rails (1 niveau) voor (stoom-)ovens (SO-).



PR3845N

Black cover for furniture when more ovens are installed in column



STONE2

Rectangular pizza stone without handles, suitable for 45cm and 60cm wide ovens. Dimensions W42 x H1.8 x D37.5cm. Ideal for cooking pizzas with the same results as a typical wood-fired oven. Can also be used for baking bread, focaccias and other recipes such as pies, flans or biscuits



AIRFRY2

Air fryer tray. Ideal for recreating traditional frying in the oven, but with fewer calories and less fat. It allows you to cook quickly and simply dishes such as French fries, fried vegetables and fish, ensuring perfect browning and crispiness.



BN620-1

Enamelled tray suitable for 45 cm and 60 cm ovens. Depth 20 mm. Perfect for a wide range of savoury and sweet baking.



BX640PL

Stainless steel perforated tray. To cook many types of vegetables, fish, white meats, ravioli or other varieties of stuffed pasta, preserving all the vitamins and mineral salts for a richer, fuller and natural flavour



ET50

Geëmailleerde ovenschaal voor 45cm en 60cm ovens. Diepte 50 mm.



GTT2

Volledig uitschuifbare telescopische rails (1 niveau) voor traditionele ovens (SO-)



PALPZ

Pizzapallet inox met plooibaar handvat, 315x325 mm































PR3845X



















Inox profiel voor installatie ovens in kolom





















Symbols glossary

- | | |
|--|--|
|  <p>Speciale kookfunctie voor de dubbelzijdige plaat-BBQ. Geschikt voor het nabootsen van sappige en knapperige gerechten in de oven met de typische smaak van gegrild koken. De geribbelde kant is bijzonder geschikt voor vleeswaren en kazen; de gladde kant voor vis, zeevruchten en groenten.</p> |  <p>The water load system is designed to enhance the aesthetics of the oven. The loading and unloading tube can be easily removed from the oven and the water refilled at any time during the cooking cycle, without opening the door, guaranteeing an infinite duration of steam.</p> |
|  <p>Sommige modellen zijn voorzien van een functie om het programma/de cyclus te blokkeren zodat het niet per ongeluk kan aangepast worden.</p> |  <p>Defrost by time: Manual defrost function. At the end of the set duration, the function stops.</p> |
|  <p>Defrost by weight: Automatic defrost function. You choose the type of food to defrost from the available categories (MEAT - FISH - BREAD - DESSERTS). After entering the weight of the food, the oven automatically defines the time required for proper defrosting.</p> |  <p>Ontkalkingsfunctie: Is essentieel om overtollige kalkaanslag in de tank te verwijderen en de goede werking van het product mogelijk te maken. De noodzaak om deze bewerking uit te voeren, wordt door het product zelf aangegeven.</p> |
|  <p>Quadruple glazed: Number of glazed doors.</p> |  <p>Automatic lighting deactivation: For greater energy savings, the lighting turns off automatically after one minute from the start of cooking. The option can be disabled via the settings menu. In this case the light will remain on for the entire duration of cooking.</p> |
|  <p>Elektrische aansluiting</p> |  <p>Ever Clean Enamel: Ever Clean enamel is applied electrostatically, corner to corner and edge to edge to prevent cracking or cracks over time. It is a particular pyrolytic enamel, resistant to acids which, in addition to being pleasantly bright, promotes greater cleaning of the oven walls, thanks to its lower porosity. It is baked at over 850 °C and slowly polymerized at a scientifically determined rate to ensure uniform depth and strength. Ever Clean enamel creates an impeccable finish both on the inside of the oven and on the trays, making the surfaces of the oven incredibly easy to maintain over time as it reduces the adhesion of fat during cooking.</p> |
|  <p>Fresh Touch: Most of Smeg ovens have a "cool door." Thanks to the combination of tangential cooling and internal heat-reflecting glasses, the temperature on the outer surface of the door is maintained below 50° C. In addition to providing safety, this system protects the sides of the furniture from overheating by the oven.</p> |  <p>Ventilator met bovenste en onderste elementen: De elementen in combinatie met de ventilator zijn bedoeld om een meer gelijkmatige warmte te bieden, een methode die vergelijkbaar is met conventioneel koken, dus voorverwarmen is vereist. Het meest geschikt voor items die langzaam koken vereisen.</p> |
|  <p>Alleen boven- en onder element: een traditionele kookmethode die het meest geschikt is voor losse items in het midden van de oven. de bovenkant van de oven zal altijd het heetst zijn. Ideaal voor gebraden vlees, fruitcake, brood etc.</p> |  <p>Base: the heat comes only from the bottom of the cavity. The fan is not active. Ideal for sweet and savory pies, cobblers and pizzas. Designed to complete cooking and make food more crunchy. This symbol in gas ovens indicates the gas burner.</p> |

-  Circulaire met onderste element: De toevoeging van het onderste element voegt extra warmte toe aan de basis voor voedsel dat extra moet worden gekookt.
-  De combinatie van de grill, de ventilator en onderwarmte is interessant voor het bereiden van kleine hoeveelheden.
-  Fan grill: very intense heat coming only from above from a double heating element. The fan is active. It allows the optimal grilling of thickest meats. Ideal for large cuts of meat.
-  Cooking with the simultaneous use of the heating element in combination with fan and microwave supply.
-  Fan combined with traditional cooking, where heat is generated from above and below, provides uniform heat. Adding the microwave function allows the same cooking results in less time.
-  Met deze functie kunnen sous-vide vacuüm verpakte ingrediënten bereid worden aan de hand van stoom.
-  Een combinatie tussen een turbine en traditioneel bakken, waarbij de warmte boven- en onderin wordt gegenereerd en samen zorgt voor een gelijkmatige warmte. Door toevoeging van stoomfunctie is hetzelfde kookresultaat mogelijk in minder tijd. Ideaal voor gebraden vlees.
-  Circulaire: De combinatie van de ventilator en het ronde element eromheen zorgt voor een hete lucht kookmethode. Dit biedt vele voordelen, waaronder geen voorverwarmen als de kooktijd meer dan 20 minuten bedraagt, geen smaakoverdracht bij het gelijktijdig bereiden van verschillende soorten voedsel, minder energie en kortere kooktijden. Geschikt voor alle soorten voedsel.
-  Grill: Very intense heat coming only from above from a double heating element. The fan is not active. Provides excellent grilling and gratinating results. Used at the end of cooking, it gives a uniform browning to dishes.
-  Microwave: Penetrating straight into the food, microwaves cook very quickly and with considerable energy savings. Suitable for cooking without fat, they are also able to thaw and heat food without altering its original appearance and aroma. The microwave function can also be combined with conventional functions with all the resulting advantages. Ideal for all types of food.
-  Microwave + grill element: The use of the grill results in a perfect browning of the surface of the food. The action of microwaves allows instead of cooking in a short time the internal part of the food.
-  Pizza function: Specific function for cooking pizza in a pan. It allows to obtain a pizza that is soft inside and crispy outside with the topping perfectly cooked, not dry and not burnt.
-  Koken met stoom: het is een natuurlijke manier van koken voor alle soorten producten, van groenten tot desserts, om de nutritionele en organoleptische eigenschappen van ingrediënten te behouden. Ideaal om te koken zonder vet, om voedsel op te warmen zonder uit te drogen. Stoom is ideaal voor het gelijktijdig bereiden van maaltijden die verschillende kooktijden vereisen.
-  Circulaire-element met stoom: koken met gelijktijdig gebruik van het ronde verwarmingselement in combinatie met ventilator en stoomtoevoer.

-  Dit pictogram/signaal geeft aan dat u water uit de reservoir moet bijvullen of ledigen.
-  Voor het creëren van een perfect geroosterd vleesgewricht. Het extra vocht houdt het vlees sappig en mals, terwijl de warmte van de grill zorgt voor een krokante korst.
-  Circulatie + onderelement met stoomondersteuning: ideaal voor het opwarmen van taartjes en quiches. Met deze functie wordt de bodem opnieuw knapperig, terwijl de vulling niet uitdroogt door het extra vocht in de kookruimte.
-  Voor het creëren van een perfect geroosterd stuk vlees. Het extra vocht houdt het vlees sappig en mals, terwijl de warmte van de turbofunctie zorgt voor de gekarameliseerde smaken die we kennen en waar we van houden.
-  All glass inner door: All glass inner door, a single flat surface which is simple to keep clean.
-  Plate rack warming: function for heating or keeping dishes warm. Place the baking tray on the lowest shelf and stack the dishes to be heated.
-  Air at 40°C provides the perfect environment for proving yeast type dough mixes. Simply select the function and place dough in the cavity for allotted
-  SABBATH: function that allows to cook food respecting Judaism's day of rest provisions.
-  The oven cavity has 2 different cooking levels.
-  Circulaire met bovenste en onderste elementen: door het gebruik van de ventilator met beide elementen kan voedsel snel en effectief worden gekookt, ideaal voor grote stukken vlees die grondig moeten worden gekookt. Het biedt een vergelijkbaar resultaat als rotisserie, waarbij de warmte rond het voedsel wordt verplaatst in plaats van het voedsel zelf te verplaatsen, waardoor elke maat of vorm kan worden gekookt.
-  Circulaire met stoomondersteuning: zorgt voor extra vocht tijdens het koken. Uitstekend geschikt voor het bakken van brood. Door het vocht kan het brooddeeg aan het begin van het koken verder uitrekken, waardoor een luchtig en licht gestructureerd deeg ontstaat. Het resterende deel van het kookproces zorgt ervoor dat de kenmerkende korst zich vormt.
-  Circulatie met Steam assist: zorgt voor extra vocht tijdens het koken. Uitstekend geschikt voor het bakken van brood. Door het vocht kan het brooddeeg aan het begin van het koken verder uitrekken, waardoor een luchtig en licht gestructureerd deeg ontstaat. Het resterende deel van het kookproces zorgt ervoor dat de kenmerkende korst zich vormt.
-  Compacte toestellen met een hoogte van 45 cm - perfecte oplossing om te voldoen aan de functionele eisen van keukensets met een kleine hoogte. Verkrijgbaar in verschillende soorten en in verschillende stijlen.
-  Met deze functie kan u bereidingen warmhouden zodat het eten niet meteen afkoelt
-  Koken met temperatuursonde: het is mogelijk om de temperatuur die herkend is door de sonde weer te geven op het display en een doeltemperatuur voor het gerecht in te stellen. Wanneer het centrum van het gerecht de juiste temperatuur heeft bereikt, stopt de functie.
-  Rapid preheating: cooking is preceded by the preheating phase which allows the cooking compartment to reach the set temperature. This option reduces the time by up to 50%.
-  Option designed to solve any doubts More than 100 pop-ups, which can be triggered with a long touch on any icon, provide information on the use of the display and cooking.
-  Smart Cooking is the perfect recipe for every occasion. Meat, fish, pasta, desserts, etc . up to 150 automatic recipes that allow to make any preparation in a single click. Decide your menu and then the oven takes care of the rest.

-  Appliances with Wi-Fi connectivity. Via SmegConnect App is possible to monitor and remotely control appliances through smartphone and tablet (iOS and Android).
-  Multistep Cooking: It is possible to set up to 3 cooking phases during the same recipe. Cooking technology, function, time and temperature can be varied. At the end of a phase, the following will start automatically.
-  Telescopic rails: allow you to pull out the dish and check it without having to remove it from the oven entirely.
-  Breed touch display
-  INSTANT GO: activating this option allow to start cooking immediately. Preheating is included in the cooking time and the oven will gradually reach the desired temperature Particularly suitable for frozen foods.
-  Only with Galileo Multi Cooking technology is it possible to combine up to three different technologies and take the best out of them: steam, microwave, convection cooking. Ovens of this generation can use any of these cooking methods individually or can combine them as desired. Both following a horizontal cooking approach (multistep) in which the various cooking techniques are arranged in sequence, and a vertical approach (multitech) in which there is a totally free combination of the three of them at the same time. Steam is healthy, microwaves are fast and traditional cooking is crispy. The oven knows how to dose them and use them wisely to guarantee innovative results with a time saving up to 70% comparing to traditional cooking.
-  The inverter technology allows to generate microwaves continuously and at the desired power. The constant flow, without on and off cycles, allows you to precisely control the temperature, reduce times, avoids wasting energy and allows you to obtain excellent cooking, defrosting and re-heating results, thanks to the smaller difference between core and surface temperature in food.
-  Vapor Clean: a simple cleaning function using steam to loosen deposits in the oven cavity.
-  The capacity indicates the amount of usable space in the oven cavity in litres.
-  Alle modellen zijn voorzien van een soft close deursysteem waarbij de deur zacht en stil sluit.
-  To guarantee the optimal functioning of the appliance, it is suggested to carry out the tank cleaning roughly once every 2-3 months.
-  Electronic control: Allows you to maintain temperature inside the oven with the precision 2-3 ° C. This enables to cook meals that are very sensitive to temperature changes, such as cakes, souffles, puddings.
-  Met deze functie kan je alle types gekookt voedsel warmhouden.
-  De multipoint temperatuursonde heeft drie detectiepunten. Hierdoor wordt niet alleen de kerntemperatuur gedetecteerd, maar ook de temperatuur in andere delen. De oven verwerkt al deze gegevens om ongelijkmatige bereidingen te voorkomen. Op deze manier kan elk product in een professionele restaurantstijl worden gekookt.
-  De perfecte manier om in een paar simpele stappen een compleet menu te hebben met een flinke tijds winst. De grote ovenruimte biedt plaats aan meerdere soorten voedsel tegelijk, die kunnen worden gekookt zonder geuruitwisseling. De zorgvuldig bestudeerde thermodynamische stromen zorgen voor uniform koken op elk niveau. Het SameTime-algoritme berekent de tijden, de kookfuncties en alle parameters zodat 3 gerechten tegelijk klaar kunnen zijn
-  The double chimney technology create a special airflow inside the cavity that reduce the condensation inside the cavity during microwave cooking, where the cavity is cold and the food is warm
-  The capacity indicates the amount of usable space in the oven cavity in litres.
- 



Active and controlled microwave distribution. The Microwave Stirrer fan distributes the waves evenly within the oven, reducing the need for a turntable.



Speciale kookfunctie voor het Airfryerrek AIRFRY. Ideaal voor het nabootsen van traditioneel frituren in de oven, maar met minder calorieën en minder vet. Hiermee kook je snel en eenvoudig gerechten zoals frites, gebakken groenten en vis, waardoor ze perfect bruin en krokant worden.



Speciale kookfunctie voor de pizzasteen STONE. Ideaal voor het bakken van pizza's met hetzelfde resultaat als een typische houtgestookte oven. Kan ook worden gebruikt voor het bakken van brood, focaccia's en andere recepten zoals taarten, vlaaien of koekjes



DeltaT cooking The oven automatically sets the cavity temperature to a predefined temperature (named deltaT) higher than the core temperature detected by the probe. When the probe detects an extra degree at the core, the oven automatically increases also its internal temperature by one degree. The oven offers the possibility to choose between three different deltaT cooking modes (slow, medium and fast) and to set any desired core temperature. A concentration of technology that makes it possible to obtain tender, juicy, healthy products of the highest quality.



Function to melt butter and chocolate without using the bain-marie



Function to soften butter and cheese It is useful for quickly bringing frozen desserts to serving temperature The function can also be used to soften ice cream



Function for the preparation of popcorn packaged in bags