

SO6102M2G



Categorie	60 cm
Familie	Oven
Voeding	Elektrisch
Bereidingswijze	Combi-magnetron
Technologie	SpeedwaveXL
Reinigingsstelsel	Vapor Clean
EAN-code	8017709326845



Design

Esthetiek	Linea	Kleur serigrafie	Zwart
Kleur	Neptune Grey	Type zeefdruk	Symbolen
Afwerking	Mat	Deur	Geheel glas
Design	Plat	Handgreep	Linea minimal
Materiaal	Glas	Kleur handgreep	Satin metal and black
Type glas	Clear1	Logo	Geëtst

Bediening



Naam display	EvoScreen	Regeling bediening	Touch control
Display technologie	LCD		

Programma's / functies

Aantal kookfuncties 11

Traditionele kookfuncties

 Statisch	 Geventileerd	 Circulaire
 ECO	 Grote vlak-grill	 Base
 Pizza		

Bereidingsfuncties met microgolven

 Magnetron	 Geventileerd	 Circulaire
 Microwave + grill		

Overige functies

 Ontdooien op tijd	 Rijsfunctie	 Stone cooking
 BBQ	 Air-Fry	 Melt
 Soft	 Pop-corn	 Sabbath

Schoonmaak functie

 Vapor Clean
--

Opties



Opties	Automatische in- en uitschakeling	Overige opties	Warmhoudfunctie, ECO-Light, Helderheid, Tonen
tijdprogrammering		Showroom demo optie	Ja
Timer	Ja	Snelle voorverwarming	Ja
Timer	1		
Kinderbeveiliging	Ja		

Technische specificaties



Minimum temperatuur	30 °C	Deur	Koud
Maximum temperatuur	250 °C	Volledig glazen binnendeur	Ja
Aantal kookniveaus	5	Totaal aantal ruiten	4
Dubbele ventilator	1	Soft Close systeem	Ja
Aantal lampen	2	Soft open & close scharnieren	Ja
Soort verlichting	Halogeen	Inverter technologie	Ja
Lamp vervangbaar	Ja	Stirrer	Ja
Vermogen lamp	40 W	Chimney	Double
Automatische inschakeling verlichting bij openen deur	Ja	Koelsysteem	Centrifugal
Onderwarmte - vermogen	1200 W	Koelleiding	Dubbel
Grill - vermogen	1750 W	Reductie snelheid koelsysteem	Ja
Circulatie - vermogen	2000 W	Afmetingen bruikbare interne ovenruimte (hxbxd)	353x470x397 mm
Automatische uitschakeling	Ja	Temperatuurregeling	Elektronisch
verhittingselementen bij openen deur		Materiaal ovenruimte	Ever Clean emaille

Deur openen

Standaard opening

Prestaties / energielabel



Netto inhoud
Aantal ovens

68 l
1

Effectief
magnetronvermogen

900 W

Meegeleverde accessoires



Ovenrooster met stop 1
Geëmailleerde diepe
bakplaat (50mm) 1
Inzetrooster 1

Glazen ovenplaat 1
Telescopische geleiders, 1
gedeeltelijk
uitschuifbaar

Elektrische aansluiting

Spanning 220-240 V
Stroom 13 A
Nominale
aansluitwaarde 3000 W

Frequentie 50/60 Hz
Lengte voedingskabel 150 cm

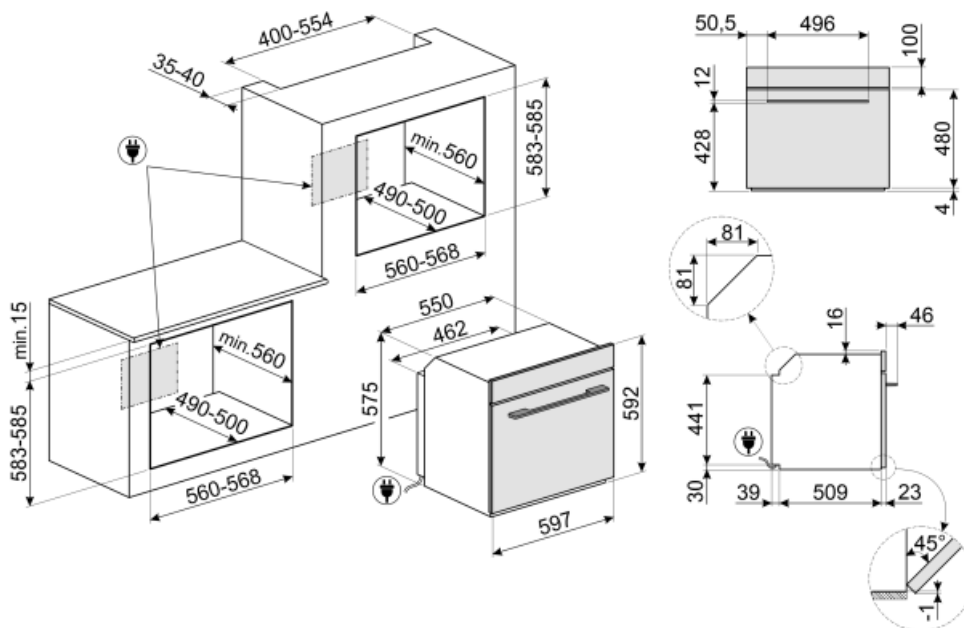

Accessoires niet inbegrepen

AIRFRY

Airfryerrek AIRFRY . Ideaal voor traditioneel frituren in de oven, maar met minder calorieën en minder vet. Hiermee creëer je snel en eenvoudig gerechten zoals frites, gebakken groenten en vis, waardoor ze perfect bruin en krokant worden.



SFLK1

Kinderslot



ET50

Geëmailleerde bakplaat, 50 mm diep



ET20

Geëmailleerde bakplaat, 20 mm diep



STONE

Rectangular refractory stone Ideal for cooking pizzas with the same results as a typical wood-fired oven. Can also be used for baking bread, focaccias and other recipes such as pies, flans or biscuits Dimensions:L42 x H1,8 x P37,5 cm.



GTP2

Gedeeltelijk uittrekbare telescopische geleiders (1 niveau), geschikt voor traditionele ovens. Ze zijn gemaakt van roestvrij staal en garanderen stabiliteit en vergemakkelijken het uitnemen van de trays.



PR3845X

Antifingerprint roestvrij staal. Afdekstrip voor meubels in kolominstallatie van meer ovens



GTT2

Totally extractable telescopic guides (1 level), suitable for traditional ovens. Made in stainless steel, they guarantee stability and facilitate the smooth extraction of the trays.



BBQ

Dubbelzijdig



PALPZ

Pizzaschep met inklapbare handgreep breedte: 315 mm lengte: 325 mm



Alternative products



SO6102M2N

Zwart



SO6102M2B3















Zwart























SO6102M2S

Zilver

Symbols glossary (TT)

 <p>Dedicated cooking function for the double sided plate BBQ. Suitable for recreating succulent and crispy dishes in the oven with the typical taste of grilled cooking. The ribbed side is particularly suitable for meats and cheeses; the smooth side for fish, seafood and vegetables.</p>	 <p>Kinderslot: sommige modellen zijn voorzien van een apparaat om het programma / de cyclus te vergrendelen zodat het niet kan per ongeluk veranderd</p>
 <p>Combination microwave: This oven allows to combine two different ways of cooking (Traditional with microwaves). Combined ovens increase cooking opportunities, while providing maximum flexibility of household appliances.</p>	 <p>Ontdooien op tijd: met deze functie wordt automatisch het tijdstip van ontdooien van voedsel bepaald</p>
 <p>The new EVOscreen display is enhanced with new, optimised colour graphics: 5 touch buttons control functions and parameters in an extremely simple way.</p>	 <p>Viervoudige beglazing: aantal glazen deuren.</p>
 <p>Automatische verlichting gaat uit: voor meer energiebesparing schakelt de verlichting automatisch uit na één minuut na het begin van de bereiding.</p>	 <p>Electric</p>
 <p>Geëmailleerde binnenkant: De geëmailleerde binnenkant van alle Smeg-ovens heeft een speciale antacidumvoering die helpt om de binnenkant schoon te houden door de hoeveelheid kookvet te verminderen.</p>	 <p>Fresh Touch: Most of Smeg ovens have a "cool door." Thanks to the combination of tangential cooling and internal heat-reflecting glasses, the temperature on the outer surface of the door is maintained below 50° C. In addition to providing safety, this system protects the sides of the furniture from overheating by the oven.</p>
 <p>Ventilator met bovenste en onderste elementen: de elementen in combinatie met de ventilator zijn bedoeld om een meer gelijkmatige warmte te bieden, een methode die vergelijkbaar is met conventioneel koken, dus voorverwarmen is vereist. Het meest geschikt voor items die langzaam koken vereisen.</p>	 <p>De ovenruimte wordt tegelijk door het onder- en bovinelement verwarmt. De hitteverdeling over het gerecht is afhankelijk van het niveau waarop men dit plaatst. Geschikt voor bakken op 1 niveau. Gerechten: alle ovenschotels, vlees, gevogelte, brood, (gevulde) taarten. Speciaal: gans en eend (bevatten veel vet).</p>
 <p>De ovenruimte wordt uitsluitend verhit door het onderelement. Voor gerechten die een hoge basistemperatuur behoeven, heeft deze bakstand weinig tot geen invloed op de korst aan de bovenzijde. Geschikt voor bakken op 1 niveau, ideaal voor deeggerechten die moeten rijzen (bijv. pizza). Bij gevulde taarten zal de deegbodem beter droog blijven.</p>	 <p>Circulaire: it is the perfect function for cooking all types of dishes in a more delicate way. The heat comes from the back of the oven and is distributed quickly and evenly The fan is active. It is also ideal for cooking on multiple levels without mixing smells and flavors.</p>

 <p>ECO: low energy consumption cooking: this function is particularly suitable for cooking on a single shelf with low energy consumption. It is recommended for all types of food except those that can generate a lot of moisture (for example vegetables). To achieve maximum energy savings and reduce time, it is recommended to put the food in the oven without preheating the cooking compartment</p>	 <p>De warmte wordt geproduceerd door het grill- en bovinelement. Verhitting over het volledige oppervlak. De thermostaat wordt, afhankelijk van het gerecht, in de regel op de maximale stand gezet. Bij een korte baktijd kan de ovendeur gesloten blijven; bij langere baktijd blijft deze gedeeltelijk geopend. Voor vleesgerechten (klein- en middelgroot), vleespennen, vis, groenten, gratineren etc.</p>
 <p>Microwave: Penetrating straight into the food, microwaves cook very quickly and with considerable energy savings. Suitable for cooking without fat, they are also able to thaw and heat food without altering its original appearance and aroma. The microwave function can also be combined with conventional functions with all the resulting advantages. Ideal for all types of food.</p>	 <p>Cooking with the simultaneous use of the heating element in combination with fan and microwave supply.</p>
 <p>Microwave + grill element: The use of the grill results in a perfect browning of the surface of the food. The action of microwaves allows instead of cooking in a short time the internal part of the food.</p>	 <p>Fan combined with traditional cooking, where heat is generated from above and below, provides uniform heat. Adding the microwave function allows the same cooking results in less time.</p>
 <p>Pizza function: Specific function for cooking pizza in a pan. It allows to obtain a pizza that is soft inside and crispy outside with the topping perfectly cooked, not dry and not burnt.</p>	 <p>All glass inner door: All glass inner door, a single flat surface which is simple to keep clean.</p>
 <p>KEEP_WARM_72dpi</p>	 <p>verlichting</p>
 <p>Air at 40°C provides the perfect environment for proving yeast type dough mixes. Simply select the function and place dough in the cavity for allotted</p>	 <p>Rapid preheating: cooking is preceded by the preheating phase which allows the cooking compartment to reach the set temperature. This option reduces the time by up to 50%.</p>
 <p>SABBATH: function that allows to cook food respecting Judaism's day of rest provisions.</p>	 <p>The oven cavity has 5 different cooking levels.</p>
 <p>Soft close: all models are equipped with advanced function of smooth closing of the door, which allows the device to close smoothly and quietly.</p>	 <p>Telescopic rails: allow you to pull out the dish and check it without having to remove it from the oven entirely.</p>
 <p>Electronic control: Allows you to maintain temperature inside the oven with the precision 2-3 ° C. This enables to cook meals that are very sensitive to temperature changes, such as cakes, souffles, puddings.</p>	 <p>Touch control: dankzij de gebruiksvriendelijke Touch control kan het apparaat met één druk op de knop worden geprogrammeerd.</p>
 <p>Vapor Clean: a simple cleaning function using steam to loosen deposits in the oven cavity.</p>	 <p>The capacity indicates the amount of usable space in the oven cavity in litres.</p>



Active and controlled microwave distribution The Microwave Stirrer fan distributes the waves evenly within the oven, reducing the need for a turntable.



The inverter technology allows to generate microwaves continuously and at the desired power The constant flow, without on and off cycles, allows you to precisely control the temperature, reduce times, avoids wasting energy and allows you to obtain excellent cooking, defrosting and re-heating results, thanks to the smaller difference between core and surface temperature in food



Speciale kookfunctie voor het Airfryerrek AIRFRY. Ideaal voor het nabootsen van traditioneel frituren in de oven, maar met minder calorieën en minder vet. Hiermee kook je snel en eenvoudig gerechten zoals frites, gebakken groenten en vis, waardoor ze perfect bruin en krokant worden.



Dedicated cooking function for the rectangular refractory stone PPR2 Dimensions Ideal for cooking pizzas with the same results as a typical wood-fired oven. Can also be used for baking bread, focaccias and other recipes such as pies, flans or biscuits



The double chimney technology create a special airflow inside the cavity that reduce the sensation inside the cavity during microwave cooking, where the cavity is cold and the food is warm



Function to melt butter and chocolate without using the bain-marie



Function to soften butter and cheese It is useful for quickly bringing frozen desserts to serving temperature The function can also be used to soften ice cream



Function for the preparation of popcorn packaged in bags