

# SO6104S4PB3



Categorie	60 cm
Familie	Oven
Vitality system	Ja
Voeding	Elektrisch
Warmte bron	Elektrisch
Bereidingswijze	Combi-stoom
Technologie	Steam100 Pro
Reinigingssysteem	Vapor Clean
EAN-code	8017709344214



## Design

Esthetiek	Linea	Type zeefdruk	Symbolen
Kleur	Zwart	Deur	Geheel glas
Design	Plat	Handgreep	Linea minimal
Materiaal	Glas	Kleur handgreep	Zwart
Type glas	Clear1	Logo	Geëts
Kleur serigrafie	Grijs		

## Bediening



Naam display	VivoScreen	Aantal weergaven talen	20
Display technologie	TFT	Weergave taal	Italiano, English (UK), Français (FR), Français (CA), Nederlands, Español (ES), Español (MX), Português (PT), Svenska, Русский, Deutsch (DE), Dansk, Norsk, Polski, English (AU), Suomi, Ukrainian, Kazakh, Afrikaans (ZA), Zulu (ZA)
Regeling bediening	Advanced full touch		

## Programma's / functies

Aantal kookfuncties	20
Automatische programma's	150
Vochtigheidsniveaus	3 + manual
Personaliseerbare recepten	10

### Traditionele kookfuncties

- |                   |              |                     |
|-------------------|--------------|---------------------|
| Statisch          | Geventileerd | Circulaire          |
| Turbohitte        | ECO          | Grote vlak-grill    |
| Fan grill (large) | Base         | Circulaire + bottom |
| Pizza             |              |                     |

### Functies met stoompulsen

- |              |            |                     |
|--------------|------------|---------------------|
| Geventileerd | Circulaire | Circulaire + Bottom |
| Turbo        | Fan Grill  |                     |

### Kookfuncties met stoom

- |                     |                         |                            |
|---------------------|-------------------------|----------------------------|
| Stoom               | Geventileerd            | Hetelucht multifunctioneel |
| Circulaire + bottom | Opwarmen en regenereren | Sous Vide                  |

### Andere Stoom-functies

- |                     |             |              |
|---------------------|-------------|--------------|
| Reiniging reservoir | Waterafvoer | Watertoevoer |
| Ontkalking          |             |              |

### Overige functies

- |                   |                      |             |
|-------------------|----------------------|-------------|
| Ontdooien op tijd | Ontdooien op gewicht | Rijsfunctie |
| Stone cooking     | BBQ                  | Air-Fry     |
| Warmhoudfunctie   | Bordenwarmfunctie    | Sabbath     |

### Schoonmaak functie

- |             |
|-------------|
| Vapor Clean |
|-------------|

## Opties



<b>Opties tijdprogrammering</b>	Automatische in- en uitschakeling	<b>DeltaT cooking</b>	Ja
<b>Timer</b>	Ja	<b>Showroom demo optie</b>	Ja
<b>Timer</b>	1	<b>Begeleide demo functie</b>	Ja
		<b>Snelgids</b>	Ja

<b>Overige opties</b>	Warmhoudfunctie, ECO-Light, Taalinstelling, Weergave digitale klok, Helderheid, Tonen, Tones volume	<b>Geheugen</b>	Ja, de 10 laatst gebruikte functies
<b>Koken met kerntemperatuurmeter</b>	Ja	<b>Snelle voorverwarming Instant GO</b>	Ja Ja
<b>Bakken in fases</b>	Ja, tot 2 stappen		
<b>Smart cooking</b>	Ja		
<b>Same Time cooking</b>	Ja		

## Technische specificaties



<b>Inhoud (l)</b>	72 l	<b>Deur</b>	Temperatuur gecontroleerde deur
<b>Cavity</b>	QS-Galileo	<b>Uitneembare ovendeur</b>	Ja
<b>Minimum temperatuur</b>	25 °C	<b>Volledig glazen binnendeur</b>	Ja
<b>Maximum temperatuur</b>	250 °C	<b>Uitneembaar glas binnendeur</b>	Ja
<b>Aantal kookniveaus</b>	5	<b>Totaal aantal ruiten</b>	3
<b>Dubbele ventilator</b>	1	<b>Soft Close systeem</b>	Ja
<b>Aantal lampen</b>	2	<b>Soft open &amp; close scharnieren</b>	Ja
<b>Soort verlichting</b>	Halogeen	<b>Chimney</b>	Variable
<b>Vermogen lamp</b>	40 W	<b>Koelsysteem</b>	Centrifugal
<b>Automatische inschakeling verlichting bij openen deur</b>	Ja	<b>Koelleiding</b>	Dubbel
<b>Onderwarmte - vermogen</b>	1200 W	<b>Reductie snelheid koelsysteem</b>	Ja
<b>Bovenwarmte - vermogen</b>	1000 W	<b>Hoeveelheid stoom</b>	20 - 100%
<b>Grill - vermogen</b>	1700 W	<b>Afmetingen bruikbare interne ovenruimte (hxbxd)</b>	353x470x397 mm
<b>Grote vlakgrill - vermogen</b>	2700 W	<b>Temperatuurregeling</b>	Elektronisch
<b>Circulatie - vermogen</b>	2000 W	<b>Materiaal ovenruimte</b>	Ever Clean emaille
<b>Automatische uitschakeling verhittingselementen bij openen deur</b>	Ja	<b>Water aansluiting</b>	Fill&Hide 2 , automatisch
<b>Deur openen</b>	Standaard opening	<b>Inhoud waterreservoir</b>	2 l

## Prestaties / energielabel



<b>Energieklasse</b>	A++	<b>Energy consumption in forced air convection</b>	1.84 MJ
<b>Netto inhoud</b>	68 l	<b>Energieverbruik bij verhittingsfunctie geforceerde hetelucht</b>	0.51 kWh
<b>Energieverbruik bij verhittingsfunctie conventioneel</b>	1.09 kWh	<b>Aantal ovens</b>	1
<b>Energy consumption in conventional mode</b>	3.92 MJ	<b>Energie-efficiëntie-index</b>	60.7 %

## Meegeleverde accessoires



Ovenrooster met stop	1
Geëmailleerde diepe bakplaat (50mm)	1
Inzetrooster	1
Rvs ovenschaal	1

Diepe geperforeerde rvs ovenschaal (40 mm)	1
Telescopische geleiders, geheel uitschuifbaar	1
Kerntemperatuurmeter	Ja, multipoint

## Elektrische aansluiting

Spanning	220-240 V
Stekker	Nee
Stroom	13 A

Nominale aansluitwaarde	3000 W
Frequentie	50/60 Hz
Lengte voedingskabel	150 cm

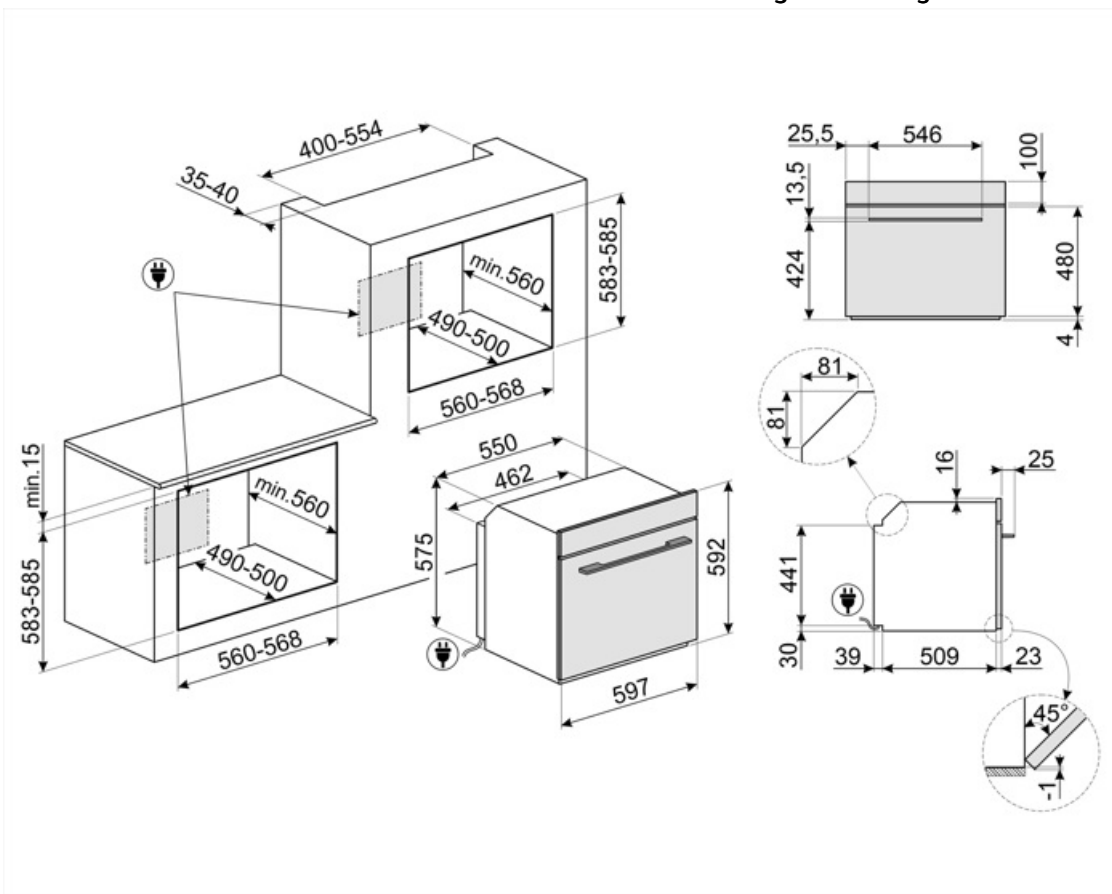

## Compatibele Accessoires

### AIRFRY

Airfryerrek AIRFRY . Ideaal voor traditioneel frituren in de oven, maar met minder calorieën en minder vet. Hiermee creëer je snel en eenvoudig gerechten zoals frites, gebakken groenten en vis, waardoor ze perfect bruin en krokant worden.



### BBQ

Dubbelzijdig



### BN640

Geëmailleerde bakplaat, 40 mm diep



### BX640PL

Roestvrijstalen geperforeerde lade. Voor het bereiden van vele soorten groenten, vis, wit vlees, ravioli of andere soorten gevulde pasta, waarbij alle vitamines en minerale zouten behouden blijven voor een rijkere, vollere en natuurlijke smaak



### ET50

Geëmailleerde bakplaat, 50 mm diep



### PALPZ

Pizzaschep met inklapbare handgreep breedte: 315 mm lengte: 325 mm



### STONE

Rectangular refractory stone Ideal for cooking pizzas with the same results as a typical wood-fired oven. Can also be used for baking bread, focaccias and other recipes such as pies, flans or biscuits Dimensions:L42 x H1,8 x P37,5 cm.



### AIRFRY2

Air fryer tray. Ideal for recreating traditional frying in the oven, but with fewer calories and less fat. It allows you to cook quickly and simply dishes such as French fries, fried vegetables and fish, ensuring perfect browning and crispiness.



### BN620-1

Geëmailleerde bakplaat, 20 mm diep



### BX640

Roestvrijstalen bakje voor stoomoven, H40xB455xD176 mm



### ET20

Geëmailleerde bakplaat, 20 mm diep



### GTTV2

Volledig uittrekbare telescopische geleiders (1 niveau), geschikt voor stoomovens. Ze zijn gemaakt van roestvrij staal en garanderen stabiliteit en vergemakkelijken het uitnemen van de trays.



### PR3845X

Antifingerprint roestvrij staal. Afdekstrip voor meubels in kolominstallatie van meer ovens

























### STONE2



















Rectangular pizza stone without handles, suitable for 45cm and 60cm wide ovens. Dimensions W42 x H1.8 x D37.5cm. Ideal for cooking pizzas with the same results as a typical wood-fired oven. Can also be used for baking bread, focaccias and other recipes such as pies, flans or biscuits





















## Symbols glossary

-  Dedicated cooking function for the double sided plate BBQ. Suitable for recreating succulent and crispy dishes in the oven with the typical taste of grilled cooking. The ribbed side is particularly suitable for meats and cheeses; the smooth side for fish, seafood and vegetables.
-  A ++: Energie-efficiëntieklasse A ++ helpt om tot 20% energie te besparen in vergelijking met klasse A. Maximale prestaties bij minimaal verbruik zijn gegarandeerd.
-  The water load system is designed to enhance the aesthetics of the oven. The loading and unloading tube can be easily removed from the oven and the water refilled at any time during the cooking cycle, without opening the door, guaranteeing an infinite duration of steam.
-  Combi-stoomovens: het stoomkookstelsel maakt het mogelijk om elk type voedsel zachter en sneller te bereiden. Variaties in temperatuur en stoomniveau zorgen voor het gewenste gastronomische resultaat. Koken met stoom vermindert het gebruik van vet ten gunste van een gezondere en meer authentieke keuken, en minimaliseert ook het verlies van gewicht en volume van voedsel tijdens het koken. Koken met stoom is perfect voor het bereiden van vlees: het maakt het niet alleen erg zacht, maar behoudt ook hun glans en maakt het sappiger. Ook aanbevolen voor het koken van gezuurd deeg en het maken van brood: vochtigheid zorgt ervoor dat het deeg tijdens het koken kan groeien en ontwikkelen voordat de buitenste korst ontstaat. Het resultaat is een lichter en beter verteerbaar deeg, herkenbaar aan de grotere alveolatie. Het is ook geschikt om snel te ontdooien, om voedsel op te warmen zonder te harden of te drogen en om gezouten voedsel op natuurlijke wijze te ontzouten.
-  Ontdooien op tijd: met deze functie wordt automatisch het tijdstip van ontdooien van voedsel bepaald
-  Ontdooien op gewicht: Met deze functie wordt de ontdooitijd bepaald
-  Ontkalkingsfunctie: Is essentieel om overtollige kalksteenafzetting in de tank te verwijderen en de goede werking van het product mogelijk te maken. De noodzaak om deze handeling uit te voeren, wordt door het product zelf aangegeven.
-  Deuren met driedubbele beglazing: aantal glazen deuren.
-  Automatische verlichting gaat uit: voor meer energiebesparing schakelt de verlichting automatisch uit na één minuut na het begin van de bereiding.
-  Electric
-  Geëmailleerde binnenkant: De geëmailleerde binnenkant van alle Smeg-ovens heeft een speciale antacidumvoering die helpt om de binnenkant schoon te houden door de hoeveelheid kookvet te verminderen.
-  Ventilator met bovenste en onderste elementen: de elementen in combinatie met de ventilator zijn bedoeld om een meer gelijkmatige warmte te bieden, een methode die vergelijkbaar is met conventioneel koken, dus voorverwarmen is vereist. Het meest geschikt voor items die langzaam koken vereisen.

-  De ovenruimte wordt tegelijk door het onder- en bovenelement verwarmt. De hitteverdeling over het gerecht is afhankelijk van het niveau waarop men dit plaatst. Geschikt voor bakken op 1 niveau. Gerechten: alle ovenschotels, vlees, gevogelte, brood, (gevulde) taarten. Speciaal: gans en eend (bevatten veel vet).
-  Circulaire with lower element: The addition of the lower element adds extra heat at the base for food which requires extra cooking.
-  ECO: low energy consumption cooking: this function is particularly suitable for cooking on a single shelf with low energy consumption. It is recommended for all types of food except those that can generate a lot of moisture (for example vegetables). To achieve maximum energy savings and reduce time, it is recommended to put the food in the oven without preheating the cooking compartment.
-  Ventilator met grillelement: De ventilator vermindert de felle hitte van de grill en biedt een uitstekende methode om verschillende soorten voedsel, karbonades, steaks, worstjes enz. Te grillen, waardoor het gelijkmatig bruin wordt en de warmte wordt verdeeld, zonder het voedsel uit te drogen. De bovenste twee niveaus die voor gebruik worden aanbevolen, en het onderste deel van de oven kunnen worden gebruikt om gerechten tegelijkertijd warm te houden, een uitstekende mogelijkheid bij het bereiden van een gegrild ontbijt. Halve grill (alleen middengedeelte) is ideaal voor kleine hoeveelheden voedsel.
-  Sous Vide Cooking: Steam function for perfect cooking of sous vide dishes. Enhances the taste of dishes and keeps their appearance and nutrients unaltered. Vacuum cooking (Sous Vide) made with the help of a steam oven is also an incredible healthy and genuine type of cooking. The Sous Vide cooking technique allows heat to be efficiently transferred from the steam to the food, avoiding the loss of flavor due to oxidation and the evaporation of nutrients and moisture during cooking. Sous Vide cooking also allows better control over the cooking of food compared to traditional methods, ensuring uniform cooking results. It also allows cooking at a lower temperature than traditional cooking.
-  De ovenruimte wordt uitsluitend verhit door het onderelement. Voor gerechten die een hoge basistemperatuur behoeven, heeft deze bakstand weinig tot geen invloed op de korst aan de bovenzijde. Geschikt voor bakken op 1 niveau, ideaal voor deeggerechten die moeten rijzen (bijv. pizza). Bij gevulde taarten zal de deegbodem beter droog blijven.
-  Circulaire: it is the perfect function for cooking all types of dishes in a more delicate way. The heat comes from the back of the oven and is distributed quickly and evenly. The fan is active. It is also ideal for cooking on multiple levels without mixing smells and flavors.
-  De warmte wordt geproduceerd door het grill- en bovenelement. Verhitting over het volledige oppervlak. De thermostaat wordt, afhankelijk van het gerecht, in de regel op de maximale stand gezet. Bij een korte baktijd kan de ovendeur gesloten blijven; bij langere baktijd blijft deze gedeeltelijk geopend. Voor vleesgerechten (klein- en middelgroot), vleespennen, vis, groenten, gratineren etc.
-  Pizza function: Specific function for cooking pizza in a pan. It allows to obtain a pizza that is soft inside and crispy outside with the topping perfectly cooked, not dry and not burnt.
-  Steam cooking: it's a natural way of cooking for any kind of products, from vegetables to desserts, to preserve the nutritional and organoleptic properties of ingredients. Ideal for cooking without fat, to heat up food without drying. Steam is ideal for simultaneous cooking of meals that require different cooking times.

- |   |  |
|---|--|
|  <p>Fun assisted + Steam: intense and homogeneous cooking. The fan is active and the heat comes from below and from above at the same time. The addition of steam allows better preservation of the organoleptic properties of food and improves the internal cooking of foods, which are more crunchy and digestible. Ideal for roast veal, roast duck and for cooking whole fish.</p> |  <p>Circulaire + Steam: The addition of steam to thermoventilated cooking allows better preservation of the organoleptic properties of food. The heat comes from the back of the oven and is distributed quickly and evenly. The fan is active. It is the perfect function for cooking all types of dishes in a more delicate way. It is also ideal for cooking on multiple levels without mixing smells and flavors. Ideal for preparing roasts, chicken and baked goods such as leavened cakes and bread.</p> |
|  <p>FUN_STEAM_OTHER_WATER_IN_OUT_72dpi</p>  |  <p>Reheat: This function can reheat precooked dishes, without becoming dry or hard.</p>  |
|  <p>Turbo: the heat comes from 3 directions: above, below and from the back of the oven. The fan is active. It allows quick cooking, even on several shelves without mixing the aromas. Ideal for large volumes or foods that require intense cooking.</p>  |  <p>Fan with grill pulsed steam: For creating a perfectly roasted meat joint. The extra moisture keeps the meat juicy and tender, whilst the heat fro</p>   |
|  <p>Circulaire pulsed steam: Provides extra moisture to food during cooking. Excellent for bread baking. The moisture allows the bread dough to stretch further at the beginning of cooking, creating an aerated and light textured dough. The remaining part of the cooking process allows for the signature crust to form.</p>  |  <p>Circulaire + lower element pulsed steam: Ideal for reheating flans and quiches. This function will re-crisp the base, whilst filling will not dry out due to the additional moisture in the cooking cavity.</p>   |
|  <p>Circulaire pulsed steam: Provides extra moisture to food during cooking. Excellent for bread baking. The moisture allows the bread dough to stretch further at the beginning of cooking, creating an aerated and light textured dough. The remaining part of the cooking process allows for the signature crust to form.</p>  |  <p>Turbo pulsed steam: For creating a perfectly roasted meat joint. The extra moisture keeps the meat juicy and tender, whilst the heat from the turbo function creates the caramelised flavours we know and love.</p>   |
|  <p>All glass inner door: All glass inner door, a single flat surface which is simple to keep clean.</p>  |  <p>The inner door glass: can be removed with a few quick movements for cleaning.</p>   |
|  <p>KEEP_WARM_72dpi</p>   |  <p>verlichting</p>   |
|  <p>Plate rack warming: function for heating or keeping dishes warm. Place the baking tray on the lowest shelf and stack the dishes to be heated.</p>   |  <p>Temperature probe: with the temperature probe it is possible to perfectly cooking roasts, loins, meat of various cuts and sizes. In fact, the probe improve food cooking, thanks to the precise control of the temperature at the heart of the dish. The core temperature of the food is measured by a special sensor located inside the tip. When the instant temperature reaches the target temperature set by the user, cooking is finished</p>  |
|  <p>Air at 40°C provides the perfect environment for proving yeast type dough mixes. Simply select the function and place dough in the cavity for allotted</p>  |  <p>Rapid preheating: cooking is preceded by the preheating phase which allows the cooking compartment to reach the set temperature. This option reduces the time by up to 50%.</p>   |

- |   |   |
|---|---|
|  <p>SABBATH: function that allows to cook food respecting Judaism's day of rest provisions.</p>   |  <p>Option designed to solve any doubts More than 100 pop-ups, which can be triggered with a long touch on any icon, provide information on the use of the display and cooking.</p>  |
|  <p>The oven cavity has 5 different cooking levels.</p>   |  <p>Smart Cooking is the perfect recipe for every occasion. Meat, fish, pasta, desserts, etc . up to 150 automatic recipes that allow to make any preparation in a single click. Decide your menu and then the oven takes care of the rest.</p>  |
|  <p>Soft close: all models are equipped with advanced function of smooth closing of the door, which allows the device to close smoothly and quietly.</p>  |  <p>To guarantee the optimal functioning of the appliance, it is suggested to carry out the tank cleaning roughly once every 2-3 months.</p>   |
|  <p>Telescopic rails: allow you to pull out the dish and check it without having to remove it from the oven entirely.</p>   |  <p>Electronic control: Allows you to maintain temperature inside the oven with the precision 2-3 ° C. This enables to cook meals that are very sensitive to temperature changes, such as cakes, souffles, puddings.</p>   |
|  <p>Vapor Clean: a simple cleaning function using steam to loosen deposits in the oven cavity.</p>  |  <p>The capacity indicates the amount of usable space in the oven cavity in litres.</p>  |
|  <p>The capacity indicates the amount of usable space in the oven cavity in litres.</p>   |  <p>The 4.3" VIVOscreen display offers an advanced colour touch interface, for automatic management of firing programmes such as Delta T, Multi-step and SameTime firing.</p>  |
|  <p>Keep warm: the function allows to keep cooked food warm.</p>  |  <p>INSTANT GO: activating this option allow to start cooking immediately. Preheating is included in the cooking time and the oven will gradually reach the desired temperature Particularly suitable for frozen foods.</p>  |
|  <p>The multi-point temperature probe has three detection points. This means that not only the core temperature is detected, but also the temperature in other areas. The oven will process all these data to avoid cooking unevenness. In this way each product can be cooked in a professional, restaurant style.</p> |  <p>The perfect way to have a complete menu in a few simple steps with a considerable saving of time. The large cavity can accommodate multiple types of food at the same time, which can be cooked without any exchange of odors. The carefully studied thermodynamic flows ensure uniform cooking at every level. The SameTime algorithm calculates the times, the cooking functions and all the parameters so that 3 foods can be ready at the same time.</p> |
|  <p>Speciale kookfunctie voor het Airfryerrek AIRFRY. Ideaal voor het nabootsen van traditioneel frituren in de oven, maar met minder calorieën en minder vet. Hiermee kook je snel en eenvoudig gerechten zoals frites, gebakken groenten en vis, waardoor ze perfect bruin en krokant worden.</p>                     |  <p>Dedicated cooking function for the rectangular refractory stone PPR2 Dimensions Ideal for cooking pizzas with the same results as a typical wood-fired oven. Can also be used for baking bread, focaccias and other recipes such as pies, flans or biscuits</p>  |



DeltaT cooking The oven automatically sets the cavity temperature to a predefined temperature (named deltaT) higher than the core temperature detected by the probe. When the probe detects an extra degree at the core, the oven automatically increases also its internal temperature by one degree. The oven offers the possibility to choose between three different deltaT cooking modes (slow, medium and fast) and to set any desired core temperature. A concentration of technology that makes it possible to obtain tender, juicy, healthy products of the highest quality.