

# SOA4102M1G



Category	45cm compact
Product Family	Oven
Power supply	Electric
Heat source	ELECTRICITY
Cooking method	Combi Microwave
Galileo Technology	Micro combi
Cleaning system	Vapour Clean
EAN code	8017709328207



## Aesthetics

Aesthetic	Linea	Serigraphy colour	Black
Colour	Neptune Grey	Serigraphy type	Symbols
Finishing	Matt	Door	Full glass
Design	Flat	Handle	Linea minimal
Material	Glass	Handle Colour	Satin metal and black
Type of steel	Brushed	Logo	Silk screen
Glass Type	Clear		

## Controls



Display name	EvoScreen	Control setting	Full touch
Display technology	LCD		

## Programs / Functions

No. of cooking functions	11
Automatic programmes	20

### Traditional cooking functions

Static	Fan assisted	Circulaire
Eco	Large grill	Base
Pizza		

### Microwave functions

Microwave	Fan assisted	Circulaire
Microwave + grill		

### Other functions

Defrost by time	Proving	Stone cooking
BBQ	Air-Fry	Sabbath

### Cleaning functions

Vapour Clean
--------------

## Options



<b>Time-setting options</b>	Delay start and automatic end cooking	<b>Other options</b>	Keep warm, Eco light, Brightness, Tones
<b>Minute minder</b>	Yes	<b>Showroom demo option</b>	Yes
<b>Timer</b>	1	<b>Rapid pre-heating</b>	Yes
<b>Controls Lock / Child Safety</b>	Yes		

## Technical Features



<b>Minimum Temperature</b>	30 °C	<b>Door</b>	Temperate door
<b>Maximum temperature</b>	250 °C	<b>Total no. of door glasses</b>	3
<b>No. of shelves</b>	3	<b>Microwave stops when door is opened</b>	Yes
<b>No. of lights</b>	2	<b>Soft Close hinges</b>	Yes
<b>Light type</b>	Halogen	<b>Soft Open</b>	Yes
<b>Light Power</b>	40 W	<b>Chimney</b>	Fixed
<b>Light when door is opened</b>	Yes	<b>Cooling system</b>	Tangential
<b>Lower heating element power</b>	1200 W	<b>Cooling duct</b>	Single
<b>Grill element - power</b>	1750 W	<b>Usable cavity space dimensions (HxWxD)</b>	211x462x401 mm

Circular heating element 1400 W  
 - Power  
 Heating suspended when door is opened Yes  
 Door opening type Standard opening

Temperature control Electronic  
 Cavity material Ever clean Enamel  
 Microwave screen protection Yes

## Performance / Energy Label



Net volume of the cavity 40 l  
 Number of cavities 1

Microwave effective power 800 W

## Accessories Included

Rack with back stop 1  
 Insert grid 1

Glass tray 1

## Electrical Connection

Plug (I) Australia  
 Voltage 220-240 V  
 Nominal power 3300 W

Frequency (Hz) 50 Hz  
 Power supply cable length 150 cm

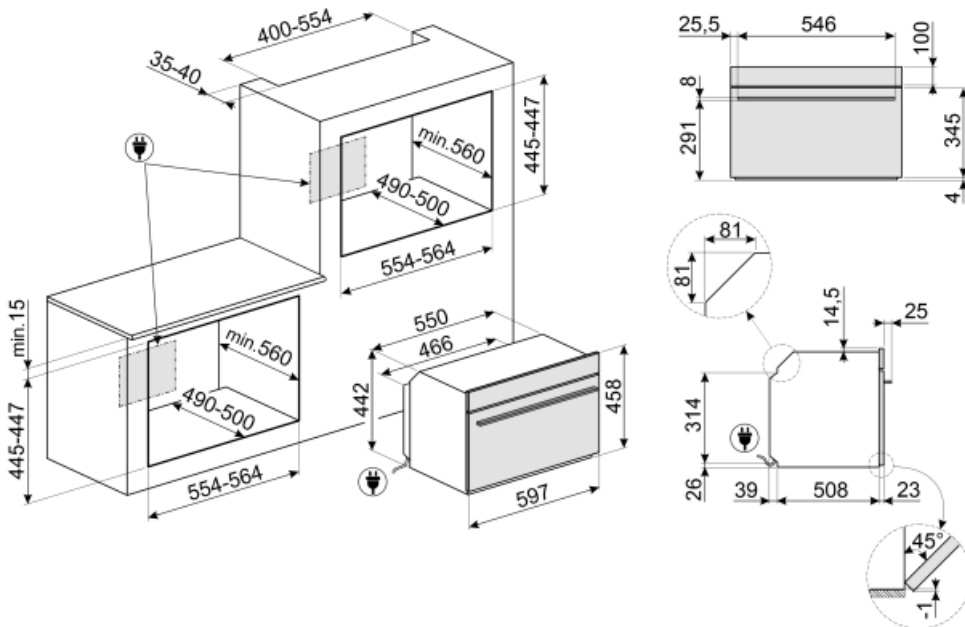

---

## Not included accessories



















---

### AIRFRY

Air fryer rack AIRFRY . Ideal for recreating traditional frying in the oven, but with fewer calories and less fat. It allows you to cook quickly and simply dishes such as French fries, fried vegetables and fish, ensuring perfect browning and crispiness.





## Symbols glossary (TT)

 <p>Child lock: some models are fitted with a device to lock the programme/cycle so it cannot be accidentally changed.</p>	 <p>Combination microwave: This oven allows to combine two different ways of cooking (Traditional with microwaves). Combined ovens increase cooking opportunities, while providing maximum flexibility of household appliances.</p>
 <p>Air cooling system: to ensure a safe surface temperatures.</p>	 <p>Defrost by time: with this function the time of thawing of foods are determined automatically.</p>
 <p>Triple glazed doors: Number of glazed doors.</p>	 <p>Automatic lighting switches off: for greater energy savings, the lighting switches off automatically after one minute from the start of cooking.</p>
 <p>Electric</p>	 <p>Enamel interior: The enamel interior of all Smeg ovens have a special antacid lining which helps keep the interior clean by reducing the amount of cooking grease adhering to it.</p>
 <p>Fan with upper and lower elements: The elements combined with the fan aim to provide more uniform heat, a similar method to conventional cooking, so pre-heat is required. Most suitable for items requiring slow cooking methods.</p>	 <p>Upper and lower element only: a traditional cooking method best suited for single items located in the centre of the oven. the top pf the oven will always be hottest. Ideal for roast, fruit cakes, bread etc.</p>
 <p>Lower heating element only: This function is ideal for foods that require extra base temperature without browning, e.g. pastry dishes, pizza. Also suitable for slow cooking of stews and casseroles.</p>	 <p>Circulaire: The combination of the fan and circular element around it gives a hot air cooking method. This provides many benefits including no preheat if cook time is more than 20 minutes, no flavour transfer when cooking different foods at the same time, less energy, and shorter cook times. Good for all types of food.</p>
 <p>ECO: The combination of the grill, fan and lower element is particularly suitable for cooking small quantities of food.</p>	 <p>Grill element: Using of grill gives excellent results when cooking meat of medium and small portions, especially when combined with a rotisserie (where possible). Also ideal for cooking sausages and bacon.</p>
 <p>Microwave: Penetrating straight into the food, microwaves cook very quickly and with considerable energy savings. Suitable for cooking without fat, they are also able to thaw and heat food without altering its original appearance and aroma. The microwave function can also be combined with conventional functions with all the resulting advantages. Ideal for all types of food.</p>	 <p>Cooking with the simultaneous use of the heating element in combination with fan and microwave supply.</p>
 <p>Microwave + grill element: The use of the grill results in a perfect browning of the surface of the food. The action of microwaves allows instead of cooking in a short time the internal part of the food.</p>	 <p>Fan combined with traditional cooking, where heat is generated from above and below, provides uniform heat. Adding the microwave function allows the same cooking results in less time.</p>

- 

Pizza function: The simultaneous operation of three elements ensures an optimum cooking facility when used with the Smeg pizza stone.



Compact appliances with a height of 45 cm - perfect solution to meet the functional requirements of kitchen sets of small height. Available in several types and in different styles.
- 

KEEP\_WARM\_72dpi



Side lights: Two opposing side lights increase visibility inside the oven.
- 

Air at 40°C provides the perfect environment for proving yeast type dough mixes. Simply select the function and place dough in the cavity for allotted



Rapid preheat: The rapid preheat function can be used to reach the selected temperature in just a few minutes.
- 

Sabbath: This function allows you to cook food during the Sabbath, the Holiday of rest in the Jewish religion, respecting the precepts. The oven works



The oven cavity has 3 different cooking levels.
- 

Soft close: all models are equipped with advanced function of smooth closing of the door, which allows the device to close smoothly and quietly.



Electronic control: Allows you to maintain temperature inside the oven with the precision 2-3 ° C. This enables to cook meals that are very sensitive to temperature changes, such as cakes, souffles, puddings.
- 

Touch controls: Easy to use touch controls allow the appliance to be programmed at the touch of a button.



Vapour Clean: a simple cleaning function using steam to loosen deposits in the oven cavity.
- 

The capacity indicates the amount of usable space in the oven cavity in litres.



...
- 

Dedicated cooking function for the double sided plate BBQ. Suitable for recreating succulent and crispy dishes in the oven with the typical taste of g



Dedicated cooking function for the Air fryer rack AIRFRY . Ideal for recreating traditional frying in the oven, but with fewer calories and less fat.
- 

Dedicated cooking function for the rectangular refractory stone PPR2 Dimensions Ideal for cooking pizzas with the same results as a typical wood-fire